

XB1004-BD

Buffer Amplifier 16.0-30.0 GHz

Rev. V1
MimiX Broadband

Features

- High Dynamic Range
- Excellent LO Driver/Buffer Amplifier
- Low Noise or Power Bias Configurations
- 21.0 dB Small Signal Gain
- 2.2 dB Noise Figure at Low Noise Bias
- +19.0 dBm P1dB Compression Point at Power Bias
- 100% On-Wafer RF, DC and Noise Figure Testing
- 100% Visual Inspection to MIL-STD-883 Method 2010
- RoHS* Compliant and 260°C Reflow Compatible

Description

M/A-COM Tech's three stage 16.0-30.0 GHz GaAs MMIC buffer amplifier has a small signal gain of 21.0 dB with a noise figure of 2.2 dB across the band. This MMIC uses M/A-COM Tech's GaAs PHEMT device model technology, and is based upon electron beam lithography to ensure high repeatability and uniformity. The chip has surface passivation to protect and provide a rugged part with backside via holes and gold metallization to allow either a conductive epoxy or eutectic solder die attach process. This device is well suited for Millimeter-wave Point-to-Point Radio, LMDS, SATCOM and VSAT applications.

Chip Device Layout

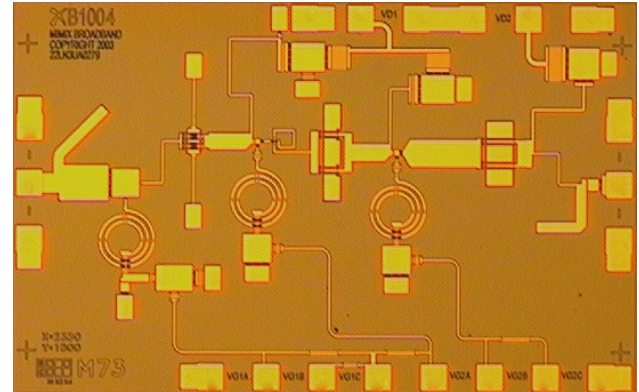

Absolute Maximum Ratings

Parameter	Absolute Max.
Supply Voltage (Vd)	+6.5 VDC
Supply Current (Id)	200 mA
Gate Bias Voltage (Vg)	+0.3 V
Input Power (Pin)	+5 dBm
Storage Temperature (Tstg)	-65 °C to +165 °C
Operating Temperature (Ta)	-55 °C to MTTF Table ¹
Channel Temperature (Tch)	MTTF Table ¹

1. Channel temperature directly affects a device's MTTF. Channel temperature should be kept as low as possible to maximize lifetime.

Ordering Information

Part Number	Package
XB1004-BD-000V	"V" - vacuum release gel paks
XB1004-BD-000W	"W" - waffle trays
XB1004-BD-EV1	evaluation module

Electrical Specifications: 16-30 GHz (Ambient Temperature T = 25°C)

Parameter	Units	Min.	Typ.	Max.
Input Return Loss (S11) ³	dB	-	15.0	-
Output Return Loss (S22) ³	dB	-	17.0	-
Small Signal Gain (S21) ³	dB	-	18.0	-
Gain Flatness ($\Delta S21$)	dB	-	+/-2.0	-
Reverse Isolation (S12) ³	dB	-	35.0	-
Noise Figure (NF) ⁴	dB	-	5.5	-
Output Power for 1dB Compression Point (P1dB) ^{1,2,3}	dBm	-	+20.0	-
Saturated Output Power (Psat) ^{1,2,3}	dBm	-	+22.0	-
Drain Bias Voltage (Vd1,2)	VDC	-	+4.0	+4.0
Gate Bias Voltage (Vg1c,2c)	VDC	-1.0	-0.23	-0.1
Supply Current (Id) (Vd=4.0 V, Vg=-0.3 V Typical)	mA	-	100	130

1. Optional low noise bias Vd1,2=4.0 V, Id=90 mA will typically yield 3-4 dB decreased P1dB and OIP3.
2. Measured using constant current.
3. Unless otherwise indicated Min/Max over 17.0-28.0 GHz and biased at Vd=6.0 V, Id1=90 mA, Id2=90 mA.
4. Unless otherwise indicated Min/Max over 17.0-28.0 GHz and biased at Vd=4.0 V, Id1=45 mA, Id2=45 mA.

XB1004-BD



Buffer Amplifier
16.0-30.0 GHz

Rev. V1
MimiX Broadband

Typical Performance Curves

XB1004-BD Vd1,2=4.0 V Id1=22.5 mA, Id2=45 mA
~7000 Devices

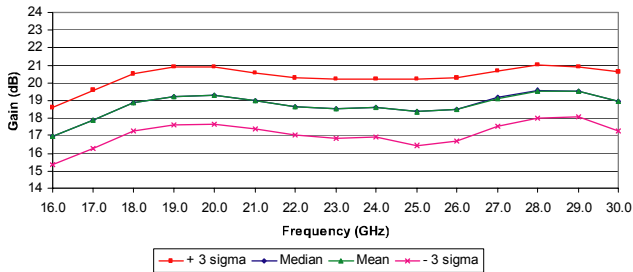

XB1004-BD Vd1,2=4.0 V Id1=22.5 mA, Id2=45 mA
~7000 Devices

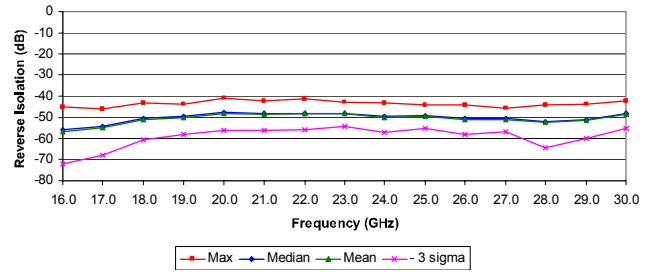

XB1004-BD Vd1,2=4.0 V Id1=22.5 mA, Id2=45 mA
~7000 Devices

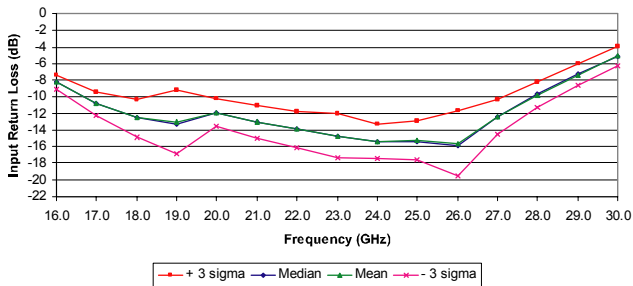

XB1004-BD Vd1,2=4.0 V Id1=22.5 mA, Id2=45 mA
~7000 Devices

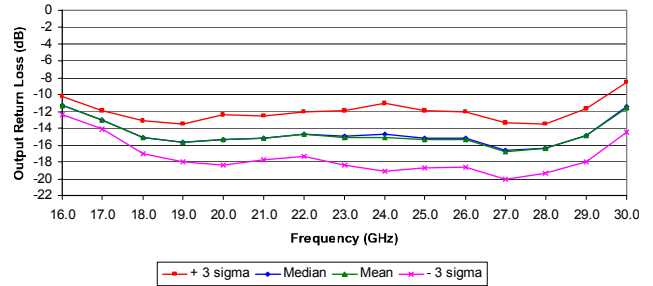

ADVANCED: Data Sheets contain information regarding a product M/A-COM Technology Solutions is considering for development. Performance is based on target specifications, simulated results, and/or prototype measurements. Commitment to develop is not guaranteed.
PRELIMINARY: Data Sheets contain information regarding a product M/A-COM Technology Solutions has under development. Performance is based on engineering tests. Specifications are typical. Mechanical outline has been fixed. Engineering samples and/or test data may be available. Commitment to produce in volume is not guaranteed.

• **North America** Tel: 800.366.2266 • **Europe** Tel: +353.21.244.6400
 • **India** Tel: +91.80.43537383 • **China** Tel: +86.21.2407.1588
 Visit www.macomtech.com for additional data sheets and product information.

M/A-COM Technology Solutions Inc. and its affiliates reserve the right to make changes to the product(s) or information contained herein without notice.

XB1004-BD



Buffer Amplifier
16.0-30.0 GHz

Rev. V1
MimiX Broadband

Typical Performance Curves (cont.)

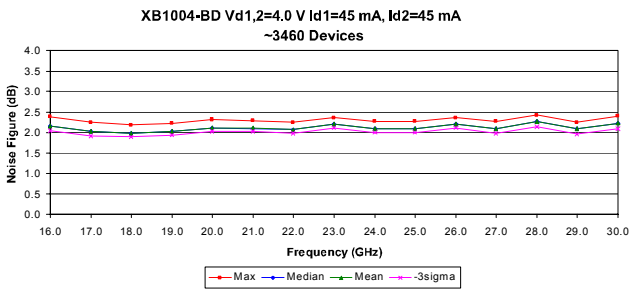
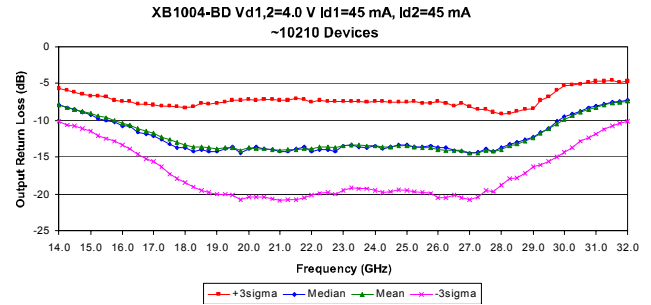
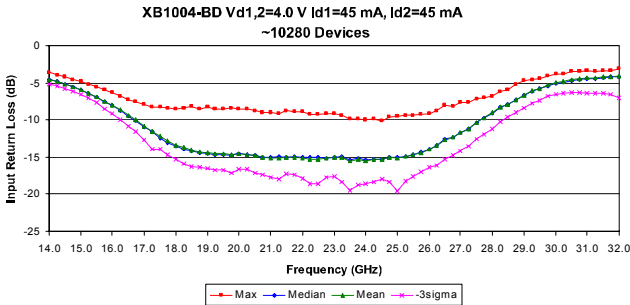
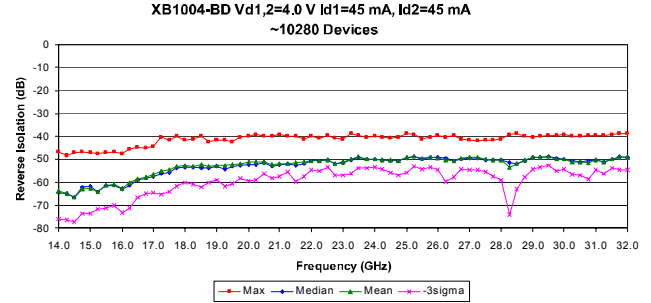
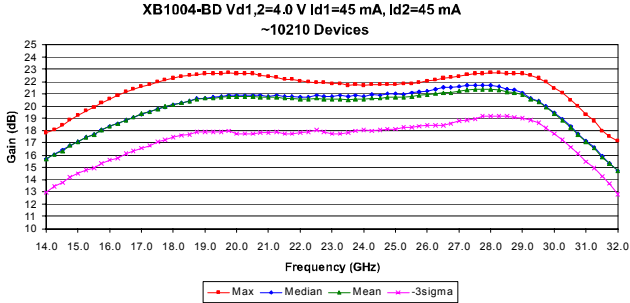

ADVANCED: Data Sheets contain information regarding a product M/A-COM Technology Solutions is considering for development. Performance is based on target specifications, simulated results, and/or prototype measurements. Commitment to develop is not guaranteed.
PRELIMINARY: Data Sheets contain information regarding a product M/A-COM Technology Solutions has under development. Performance is based on engineering tests. Specifications are typical. Mechanical outline has been fixed. Engineering samples and/or test data may be available. Commitment to produce in volume is not guaranteed.

• **North America** Tel: 800.366.2266 • **Europe** Tel: +353.21.244.6400
• **India** Tel: +91.80.43537383 • **China** Tel: +86.21.2407.1588
Visit www.macomtech.com for additional data sheets and product information.

M/A-COM Technology Solutions Inc. and its affiliates reserve the right to make changes to the product(s) or information contained herein without notice.

XB1004-BD



Buffer Amplifier
16.0-30.0 GHz

Rev. V1
MimiX Broadband

Typical Performance Curves (cont.)

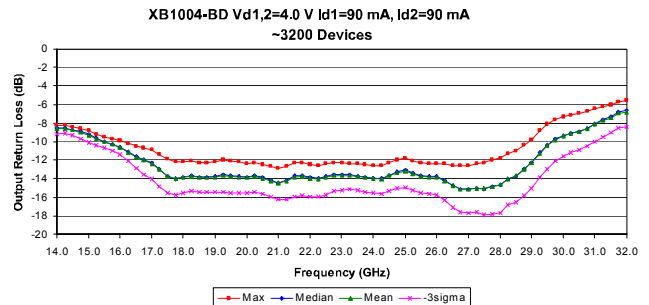
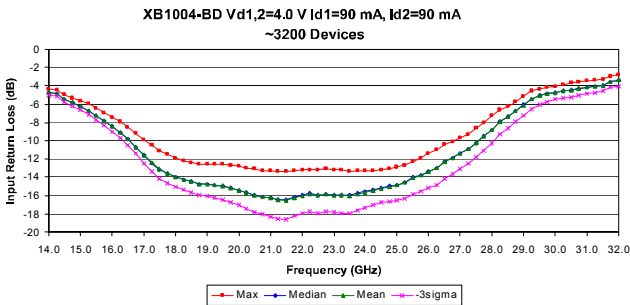
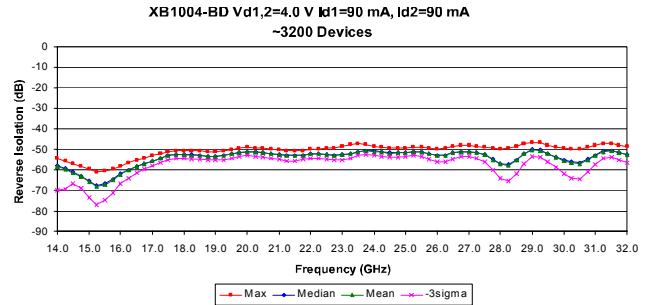
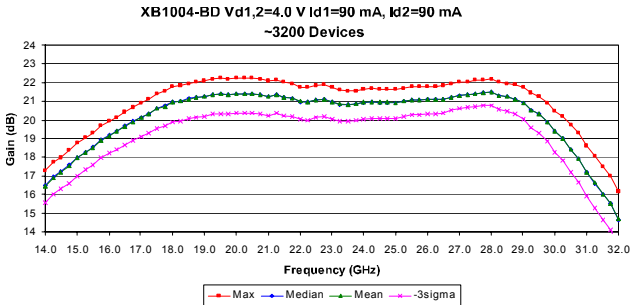

ADVANCED: Data Sheets contain information regarding a product M/A-COM Technology Solutions is considering for development. Performance is based on target specifications, simulated results, and/or prototype measurements. Commitment to develop is not guaranteed.
PRELIMINARY: Data Sheets contain information regarding a product M/A-COM Technology Solutions has under development. Performance is based on engineering tests. Specifications are typical. Mechanical outline has been fixed. Engineering samples and/or test data may be available. Commitment to produce in volume is not guaranteed.

• **North America** Tel: 800.366.2266 • **Europe** Tel: +353.21.244.6400
• **India** Tel: +91.80.43537383 • **China** Tel: +86.21.2407.1588
Visit www.macomtech.com for additional data sheets and product information.

M/A-COM Technology Solutions Inc. and its affiliates reserve the right to make changes to the product(s) or information contained herein without notice.

Typical Performance Curves (cont.)

XB1004-BD_R2C2: Pout vs. freq_R2C2

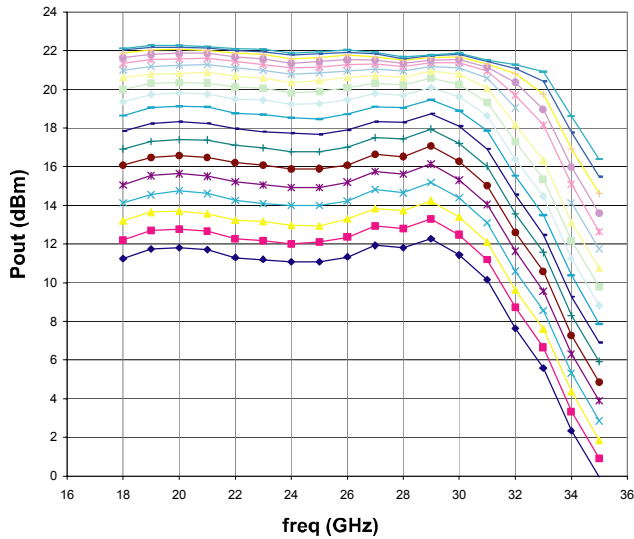

XB1004-BD: Pout vs. freq at -10, -3 and 7dBm

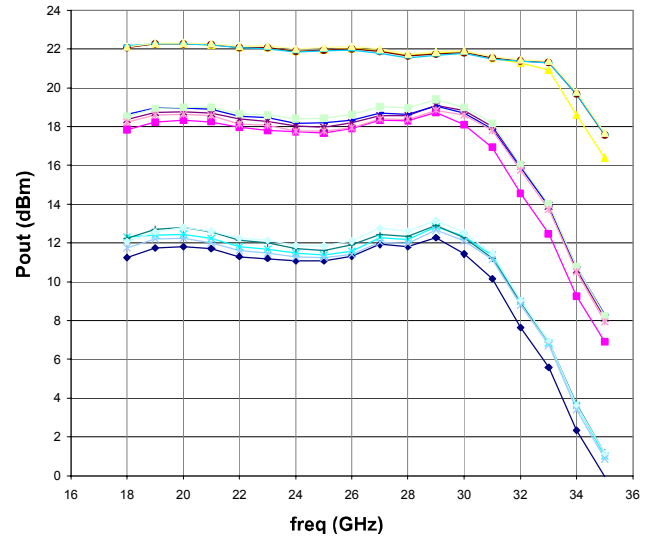

XB1004-BD_R3C3: OP1dB

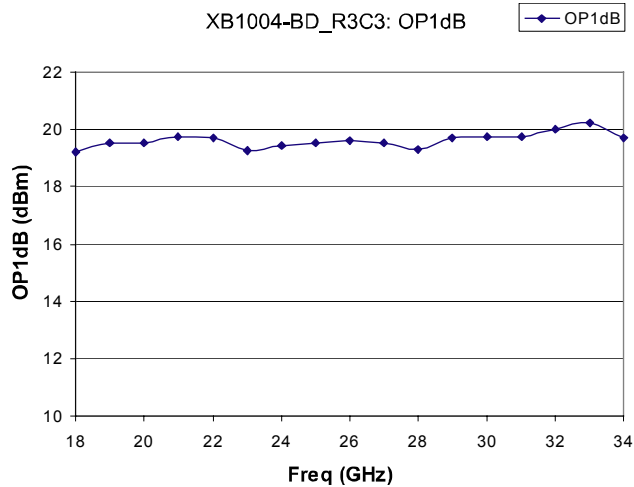

XB1004-BD



Buffer Amplifier 16.0-30.0 GHz

Rev. V1
MimiX Broadband

S-Parameters

Typical S-Parameter Data for XB1004-BD
Vd=4 V Id1=45 mA Id2=45 mA

Frequency (GHz)	S11 Mag dB	S11 Phase Ang°	S12 Mag dB	S12 Phase Ang°	S21 Mag dB	S21 Phase Ang°	S22 Mag dB	S22 Phase Ang°
14.00	-4.488006386	160.3477	-65.20547853	97.9597	15.91141774	80.4131	-7.961292105	156.364
14.25	-4.780466353	156.7746	-65.04914525	130.745	16.26308988	72.75384	-8.307793633	81.76258
14.50	-5.090069626	153.2923	-66.83487195	144.4173	16.58581284	66.05664	-8.516462366	17.58182
14.75	-5.515642302	149.3398	-62.82813364	145.9903	16.96448878	58.3271	-8.817693057	-60.40213
15.00	-5.908319039	146.0351	-62.15152842	140.1351	17.27640243	51.4296	-9.116250938	-125.5226
15.25	-6.36492729	142.3947	-63.79403343	139.2024	17.6306096	43.16068	-9.490746359	152.1885
15.50	-6.835321917	139.2067	-61.55571655	135.3048	17.89655959	36.43289	-9.758978333	91.87538
15.75	-7.443645645	135.8314	-61.61834811	136.4185	18.23731044	27.96522	-10.0850734	15.17566
16.00	-7.954014568	133.451	-62.87801498	130.6166	18.53392439	21.13839	-10.44926621	-49.12296
16.25	-8.613494027	130.5553	-60.97586254	155.2967	18.79434566	12.62619	-10.70325156	-126.3388
16.50	-9.351339718	128.5114	-59.08234194	149.3536	19.06419509	4.264312	-11.23343585	150.939
16.75	-9.938284456	126.7418	-58.07570032	153.9659	19.2955573	-2.923985	-11.49338288	89.83047
17.00	-10.72781907	125.6761	-57.10236855	145.1132	19.55954352	-11.07268	-11.84807057	15.57915
17.25	-11.45757287	125.1995	-55.63348472	146.4742	19.73877049	-18.24617	-12.26263506	-47.66284
17.50	-12.10581429	125.4995	-55.25927565	142.45	19.96235376	-27.11272	-12.70872047	-123.7843
17.75	-12.78314466	126.4037	-53.62911008	137.6782	20.12122686	-33.96728	-13.08797618	167.1598
18.00	-13.40563631	128.1031	-53.49785092	126.705	20.31749415	-42.63926	-13.38602103	94.69427
18.25	-13.76917019	130.3096	-53.59193789	118.0486	20.45549686	-50.03904	-13.55092416	35.52287
18.50	-14.12698	132.3081	-53.18089883	118.702	20.58039147	-58.52836	-13.66587745	-40.1016
18.75	-14.48203359	134.6221	-53.36091684	115.3193	20.75502996	-67.11792	-13.7915767	-115.0743
19.00	-14.55165735	136.2222	-52.97969443	109.4043	20.80511699	-74.15998	-13.84992904	44.88443
19.25	-14.63942028	136.5078	-53.42822181	101.9631	20.86890808	-82.84879	-13.7461338	102.1477
19.50	-14.68157629	137.3111	-53.1769237	103.6469	20.93192687	-89.86997	-13.75692934	41.94405
19.75	-14.74099805	139.6776	-52.39693469	104.5834	20.97333211	-97.89622	-14.05814122	-33.67156
20.00	-14.51000349	138.8338	-51.49852234	95.15817	20.98201169	-105.3744	-13.81447312	-96.83292
20.25	-14.62534716	138.1341	-51.66603657	96.65334	20.98524967	-113.0653	-13.90279702	-168.5283
20.50	-14.70616526	136.6651	-51.38333793	82.06539	20.99616315	-120.2752	-13.77821296	120.4647
20.75	-14.90553527	136.5904	-52.71399942	82.86057	20.96910204	-128.1374	-13.92470348	44.1559
21.00	-15.02357419	135.813	-52.10524654	79.37607	20.89622002	-135.913	-14.0619026	-31.24287
21.25	-15.05015808	135.6739	-52.02010887	76.92526	20.91884446	-142.6171	-14.0289345	-93.15093
21.50	-15.10655145	134.7054	-52.22623499	71.78536	20.84428402	-150.0642	-13.99375336	-166.7917
21.75	-14.98337453	135.7253	-51.58492383	80.65435	20.84540286	-156.16	-13.93191213	126.4174
22.00	-15.0534118	132.4365	-50.65432343	70.29443	20.79089267	-163.8192	-13.80462928	50.23223
22.25	-15.18069607	130.7094	-51.01217322	64.31312	20.77090997	-169.6259	-13.66911466	-14.48867
22.50	-15.12574012	129.0565	-50.0589988	56.86007	20.8603409	-170.5688	-13.58380875	-91.78304
22.75	-15.08626965	128.2232	-51.74807807	55.47022	20.81792882	-172.9285	-13.7221915	-152.1783
23.00	-14.99602393	124.8725	-51.13032313	53.64964	20.80876731	-168.9904	-13.53672031	126.3781
23.25	-14.8537183	120.3659	-50.17404016	57.88192	20.8115805	-161.4748	-13.32979145	51.83643
23.50	-15.36344283	116.3281	-49.045145	43.18889	20.73456942	-155.6715	-13.35741826	-14.95574
23.75	-15.0946598	115.1304	-49.85819483	43.34335	20.81239514	-148.4648	-13.40357247	-90.19309
24.00	-15.39735257	112.4639	-49.72499596	32.64002	20.75503497	-142.5701	-13.4656704	-152.0927
24.25	-15.13095054	109.5295	-50.13093024	30.30852	20.83643776	-135.1379	-13.55071132	126.8156
24.50	-15.1744339	106.0131	-50.20715943	25.31852	20.83040005	-129.3736	-13.65003675	62.67419
24.75	-14.87939547	100.8113	-50.50249522	26.3597	20.89856238	-121.75	-13.52521517	-12.75818
25.00	-14.90477717	96.33096	-49.57069959	21.51729	20.90054564	-115.4541	-13.5387876	-76.76747
25.25	-14.67738998	91.03966	-48.74758629	21.70694	20.89195512	-108.3276	-13.57528524	-150.5746
25.50	-14.38830456	87.22176	-49.67421973	8.14969	20.99917398	-101.1408	-13.72233378	127.6319
25.75	-14.13837685	81.97481	-48.96714338	5.585327	21.04299246	-94.48246	-13.85032041	64.45851
26.00	-13.68285147	75.85893	-49.1836183	-3.681355	21.12871511	-87.0444	-14.05533839	-10.21604
26.25	-13.22837385	70.50666	-50.06582294	-14.11971	21.2527216	-80.46708	-14.16774214	-72.27026
26.50	-12.44232727	62.4766	-50.54932781	-23.09788	21.34178196	-71.82767	-14.09760141	-142.9784
26.75	-12.1231902	55.19888	-49.5366484	-9.982013	21.34760323	-65.34277	-14.12675521	142.8106
27.00	-11.51541544	48.33369	-49.01919565	-31.26795	21.48924461	-56.8985	-14.44884399	72.33661
27.25	-10.95899259	42.02633	-49.27235222	-36.02533	21.51576377	-49.67164	-14.46870091	12.9942
27.50	-10.17930299	33.51711	-49.83416656	-45.60722	21.56439576	-40.38253	-14.03623103	-61.09192
27.75	-9.486668382	24.41982	-50.21434656	-51.82261	21.54985487	-31.15906	-14.18198677	-136.7268
28.00	-8.86384684	18.61195	-49.92261375	-63.95271	21.58096768	-23.28123	-13.83955787	155.505
28.25	-8.082733695	9.647546	-52.65291204	-77.20475	21.5193103	-13.39679	-13.31467582	84.48412
28.50	-7.684183764	1.679874	-52.09575618	-69.46488	21.34695902	5.231442	-13.13934105	24.31771
28.75	-7.134292488	-5.842427	-50.43673429	-76.09734	21.24451683	-4.82478	-12.71549435	-46.76101
29.00	-6.52197965	-12.848	-48.94679421	-89.84153	21.06557481	-13.77886	-12.1811325	-110.1438
29.25	-5.998240777	-22.03921	-49.27311546	-105.3236	20.72026144	-23.99692	-11.4541009	164.9588
29.50	-5.644587238	-28.6075	-48.72771039	-119.9739	20.41443603	-32.80532	-10.89193703	104.8088
29.75	-5.27953438	-37.44137	-49.74170856	-140.7835	19.94991228	-42.83006	-10.21068599	29.38953
30.00	-4.941451463	-44.89988	-49.85115212	-150.2209	19.44888726	-52.45927	-9.575210602	-48.08296
30.25	-4.825257403	-51.70079	-51.02755692	-151.5981	18.89354455	-60.66542	-9.177802992	-114.5268
30.50	-4.615118041	-58.4916	-51.29842096	-154.4575	18.30012391	-69.80401	-8.690316302	159.8694
30.75	-4.44721087	-63.4305	-51.03586887	-157.2381	17.75344043	-76.78794	-8.348029064	96.70776
31.00	-4.355991672	-69.75317	-50.4634257	-157.4598	17.08638984	-85.54248	-7.999071087	20.62207
31.25	-4.322415263	-74.47208	-51.17707418	-159.6716	16.58920074	-92.28	-7.750419231	-45.304
31.50	-4.206464968	-79.78357	-49.76725044	-156.0792	15.83669567	-100.0134	-7.49742569	-124.8377
31.75	-4.173257655	-83.59286	-49.13513642	-141.7404	15.33144978	-106.2723	-7.376597896	163.0723
32.00	-4.143739107	-88.26109	-49.28087624	-132.9657	14.71038311	-112.2931	-7.215566664	87.67538

ADVANCED: Data Sheets contain information regarding a product M/A-COM Technology Solutions is considering for development. Performance is based on target specifications, simulated results, and/or prototype measurements. Commitment to develop is not guaranteed.

PRELIMINARY: Data Sheets contain information regarding a product M/A-COM Technology Solutions has under development. Performance is based on engineering tests. Specifications are typical. Mechanical outline has been fixed. Engineering samples and/or test data may be available. Commitment to produce in volume is not guaranteed.

• **North America** Tel: 800.366.2266 • **Europe** Tel: +353.21.244.6400
• **India** Tel: +91.80.43537383 • **China** Tel: +86.21.2407.1588

Visit www.macomtech.com for additional data sheets and product information.

M/A-COM Technology Solutions Inc. and its affiliates reserve the right to make changes to the product(s) or information contained herein without notice.

XB1004-BD



Buffer Amplifier
16.0-30.0 GHz

Rev. V1
MimiX Broadband

Mechanical Drawing

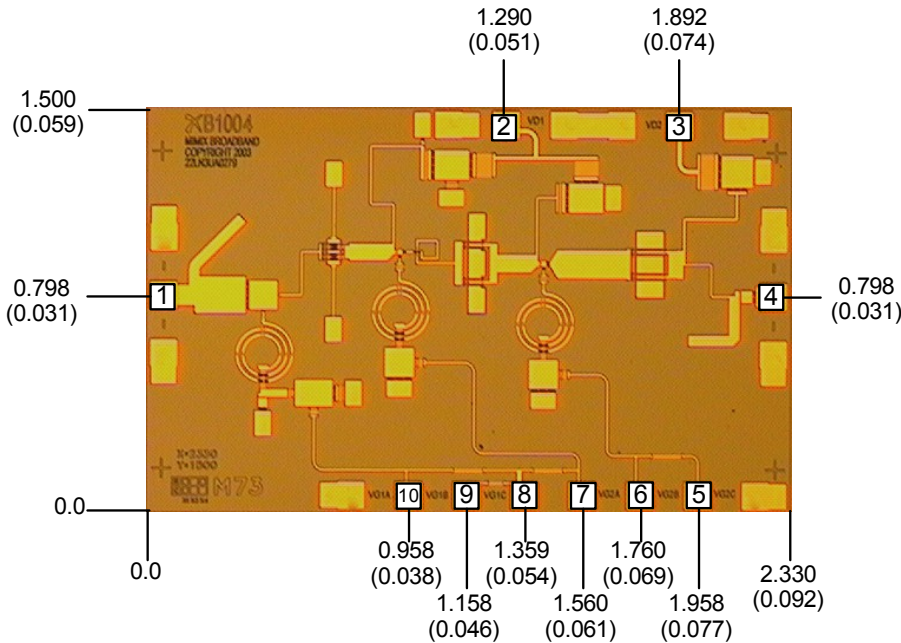

(Note: Engineering designator is 22LN3UA0279)

Units: millimeters (inches) Bond pad dimensions are shown to center of bond pad.
Thickness: 0.110 +/- 0.010 (0.0043 +/- 0.0004), Backside is ground, Bond Pad/Backside Metallization: Gold
All Bond Pads are 0.100 x 0.100 (0.004 x 0.004).
Bond pad centers are approximately 0.109 (0.004) from the edge of the chip.
Dicing tolerance: +/- 0.005 (+/- 0.0002). Approximate weight: 2.165 mg.

Bond Pad #1 (RF In)	Bond Pad #3 (Vd2)	Bond Pad #5 (Vg2c)	Bond Pad #7 (Vg2a)	Bond Pad #9 (Vg1b)
Bond Pad #2 (Vd1)	Bond Pad #4 (RF Out)	Bond Pad #6 (Vg2b)	Bond Pad #8 (Vg1c)	Bond Pad #10 (Vg1a)

Bias Arrangement

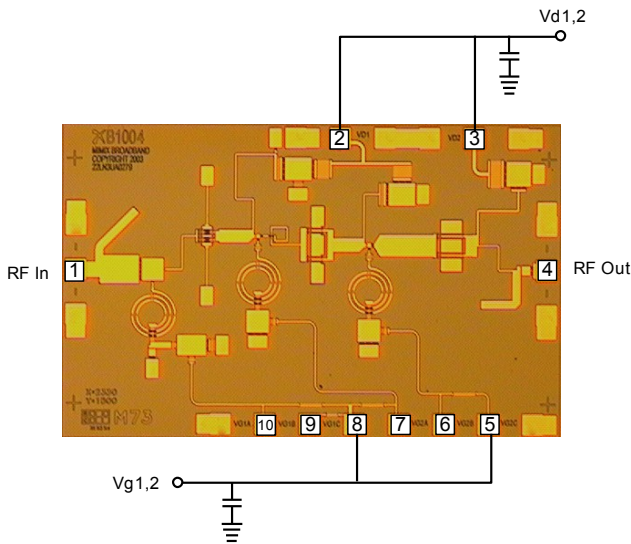

Bypass Capacitors - See App Note [2]

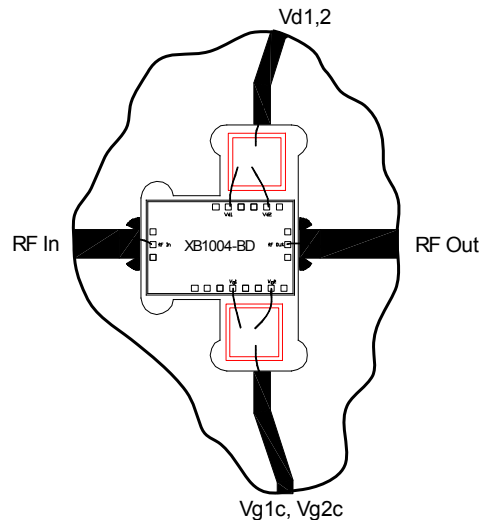

ADVANCED: Data Sheets contain information regarding a product M/A-COM Technology Solutions is considering for development. Performance is based on target specifications, simulated results, and/or prototype measurements. Commitment to develop is not guaranteed.
PRELIMINARY: Data Sheets contain information regarding a product M/A-COM Technology Solutions has under development. Performance is based on engineering tests. Specifications are typical. Mechanical outline has been fixed. Engineering samples and/or test data may be available. Commitment to produce in volume is not guaranteed.

• **North America** Tel: 800.366.2266 • **Europe** Tel: +353.21.244.6400
• **India** Tel: +91.80.43537383 • **China** Tel: +86.21.2407.1588
Visit www.macomtech.com for additional data sheets and product information.

M/A-COM Technology Solutions Inc. and its affiliates reserve the right to make changes to the product(s) or information contained herein without notice.

XB1004-BD



Buffer Amplifier
16.0-30.0 GHz

Rev. V1
MimiX Broadband

MTTF Tables

These numbers were calculated based on accelerated life test information and thermal model analysis received from the fabricating foundry.

Backplate Temperature	Channel Temperature	Rth	MTTF Hours	FITs
55 deg Celsius	83.4 deg Celsius	78.8° C/W	5.36E+10	1.87E-02
75 deg Celsius	105.5 deg Celsius	84.7° C/W	3.52E+09	2.84E-01
95 deg Celsius	127.4 deg Celsius	90.0° C/W	3.206E+08	3.13E+00

Bias Conditions: Vd1=Vd2=4.0V, Id1=45 mA, Id2=45 mA

Backplate Temperature	Channel Temperature	Rth	MTTF Hours	FITs
55 deg Celsius	108.3 deg Celsius	76.1° C/W	2.56E+09	3.91E-01
75 deg Celsius	132.1 deg Celsius	81.5° C/W	1.992E+08	5.04E+00
95 deg Celsius	155.5 deg Celsius	86.4° C/W	2.12E+07	4.72E+01

Bias Conditions: Vd1=Vd2=5.0V, Id1=70 mA, Id2=70 mA

Backplate Temperature	Channel Temperature	Rth	MTTF Hours	FITs
55 deg Celsius	138.1 deg Celsius	77.0° C/W	1.08E+08	9.22E-00
75 deg Celsius	163.7 deg Celsius	82.1° C/W	1.02E+07	9.82E+01
95 deg Celsius	188.8 deg Celsius	86.8° C/W	1.29E+06	7.73E+02

Bias Conditions: Vd1=Vd2=6.0V, Id1=90 mA, Id2=90 mA

App Note [1] Biasing - As shown in the bonding diagram, this device can be operated with all three stages in parallel, and can be biased for low noise performance or high power performance. Low noise bias is nominally $V_d=4V$, $I_d=90mA$. More controlled performance will be obtained by separately biasing V_{d1} and V_{d2} each at $4.0V$, $45mA$. Power bias may be as high as $V_d=6.0V$, $I_d=180mA$ with all stages in parallel, or most controlled performance will be obtained by separately biasing V_{d1} and V_{d2} each at $6.0V$, $90mA$. It is also recommended to use active biasing to keep the currents constant as the RF power and temperature vary; this gives the most reproducible results. Depending on the supply voltage available and the power dissipation constraints, the bias circuit may be a single transistor or a low power operational amplifier, with a low value resistor in series with the drain supply used to sense the current. The gate of the pHEMT is controlled to maintain correct drain current and thus drain voltage. The typical gate voltage needed to do this is $-0.3V$. Typically the gate is protected with Silicon diodes to limit the applied voltage. Also, make sure to sequence the applied voltage to ensure negative gate bias is available before applying the positive drain supply.

App Note [2] Bias Arrangement -

For Parallel Stage Bias (Recommended for general applications) -- The same as Individual Stage Bias but all the drain or gate pad DC bypass capacitors ($\sim 100-200$ pf) can be combined. The suggested configuration is to connect $V_{d1,2}$ and $V_{g1c,2c}$. Additional DC bypass capacitance (~ 0.01 uF) is also recommended to all DC or combination (if gate or drains are tied together) of DC bias pads.

For Individual Stage Bias (Low Input Drive applications only) -- Each DC pad ($V_{d1,2}$ and $V_{g1a,2a,2b}$) needs to have DC bypass capacitance ($\sim 100-200$ pf) as close to the device as possible. Additional DC bypass capacitance (~ 0.01 uF) is also recommended.

For Individual Stage Bias (High Input Drive applications only) -- Each DC pad ($V_{d1,2}$ and $V_{g1c,2c}$) needs to have DC bypass capacitance ($\sim 100-200$ pf) as close to the device as possible. Additional DC bypass capacitance (~ 0.01 uF) is also recommended.

Device Schematic

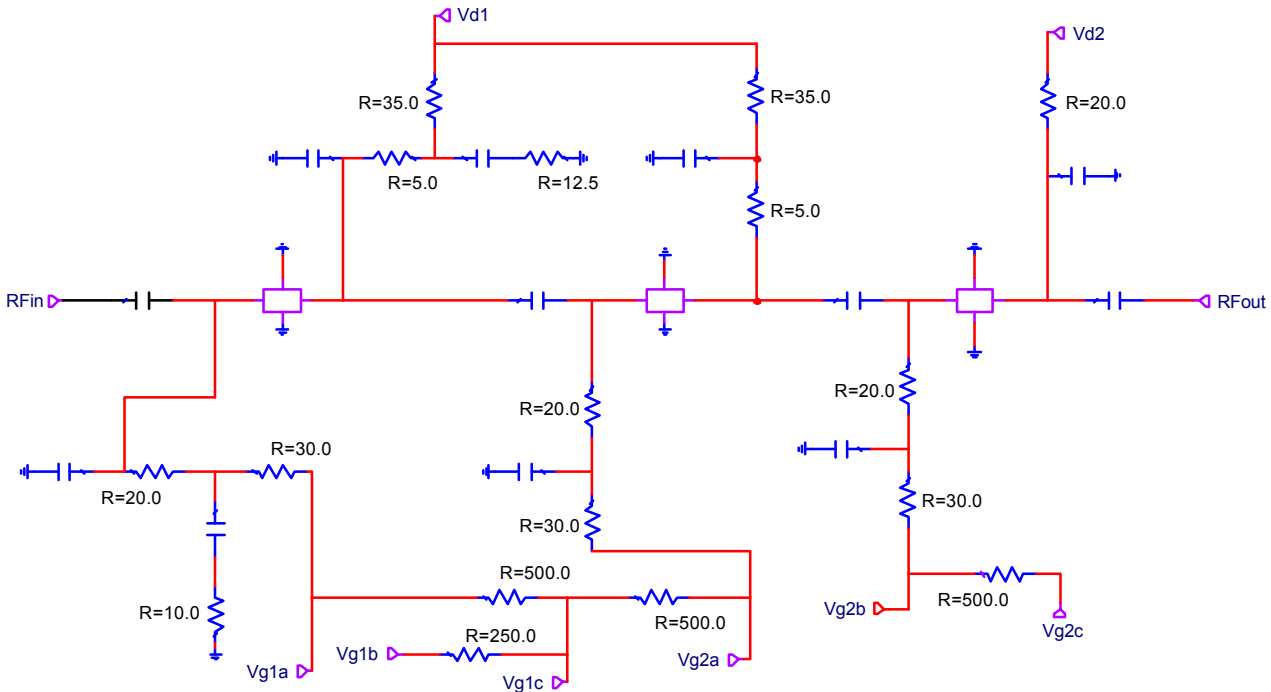

Typical Application

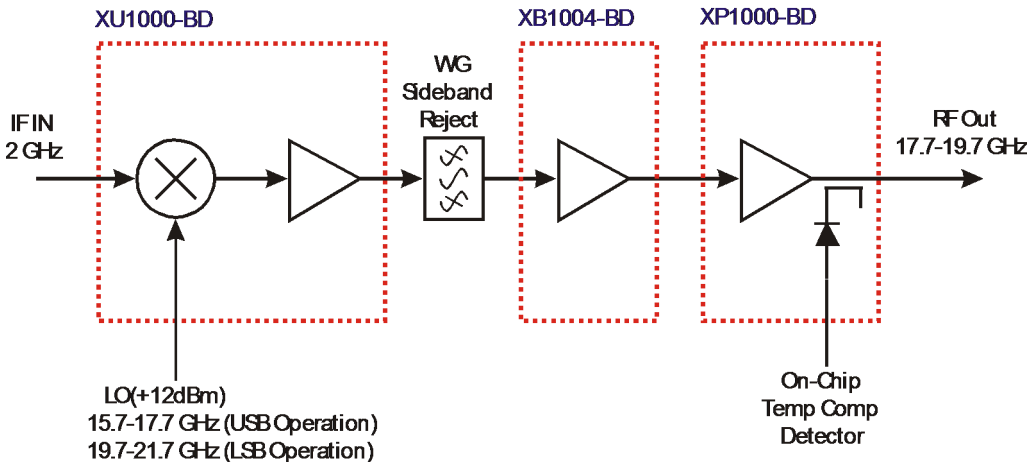

M/A-COM Tech MMIC-based 17.0-27.0 GHz Transmitter Block Diagram
(Changing LO and IF frequencies as required allows design to operate as high as 27 GHz)

Handling Procedures

Please observe the following precautions to avoid damage:

Static Sensitivity

Gallium Arsenide Integrated Circuits are sensitive to electrostatic discharge (ESD) and can be damaged by static electricity. Proper ESD control techniques should be used when handling these class 2 devices.