

The RF MOSFET Line 80W, 175MHz, 28V

Rev. V1

Designed for broadband commercial and military applications up to 200 MHz frequency range. The high-power, high-gain and broadband performance of this device makes possible solid state transmitters for FM broadcast or TV channel frequency bands.

N-Channel enhancement mode MOSFET

- Guaranteed performance at 150 MHz, 28 V:
Output power = 80 W
Gain = 11 dB (13 dB typ.)
Efficiency = 55% Min. (60% typ.)
- Low thermal resistance
- Ruggedness tested at rated output power
- Nitride passivated die for enhance
- ed reliability
- Low noise figure — 1.5 dB typ. at 2.0 A, 150 MHz
- Excellent thermal stability; suited for Class A operation

Product Image

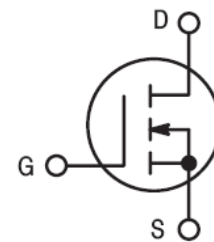
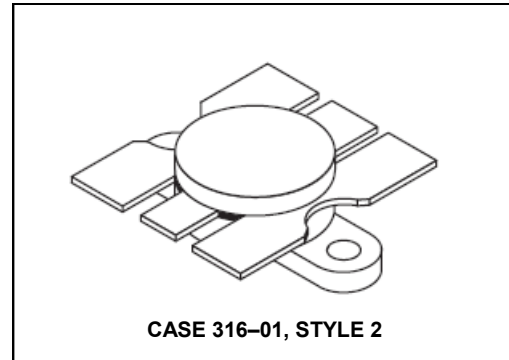

MAXIMUM RATINGS

Rating	Symbol	Value	Unit
Drain-Source Voltage	V_{DSS}	65	Vdc
Drain-Gate Voltage	V_{DGO}	65	Vdc
Gate-Source Voltage	V_{GS}	± 40	Vdc
Drain Current — Continuous	I_D	9.0	Adc
Total Device Dissipation @ $T_C = 25^\circ\text{C}$ Derate above 25°C	P_D	220 1.26	Watts W/°C
Storage Temperature Range	T_{stg}	-65 to +150	°C
Operating Temperature Range	T_J	200	°C

THERMAL CHARACTERISTICS

Characteristic	Symbol	Max	Unit
Thermal Resistance, Junction to Case	$R_{\theta JC}$	0.8	°C/W

ELECTRICAL CHARACTERISTICS ($T_C = 25^\circ\text{C}$ unless otherwise noted)

Characteristic	Symbol	Min	Typ	Max	Unit
----------------	--------	-----	-----	-----	------

OFF CHARACTERISTICS

Drain-Source Breakdown Voltage ($V_{DS} = 0\text{ V}$, $V_{GS} = 0\text{ V}$) $I_D = 50\text{ mA}$	$V_{(BR)DSS}$	65	—	—	V
Zero Gate Voltage Drain Current ($V_{DS} = 28\text{ V}$, $V_{GS} = 0\text{ V}$)	I_{DSS}	—	—	2.0	mA
Gate-Source Leakage Current ($V_{GS} = 40\text{ V}$, $V_{DS} = 0\text{ V}$)	I_{GSS}	—	—	1.0	μA

ON CHARACTERISTICS

Gate Threshold Voltage ($V_{DS} = 10\text{ V}$, $I_D = 50\text{ mA}$)	$V_{GS(th)}$	1.0	3.0	6.0	V
Drain-Source On-Voltage ($V_{DS(on)}$, $V_{GS} = 10\text{ V}$, $I_D = 3.0\text{ A}$)	$V_{DS(on)}$	—	—	1.4	V
Forward Transconductance ($V_{DS} = 10\text{ V}$, $I_D = 2.0\text{ A}$)	g_{fs}	1.8	2.2	—	mhos

(continued)

NOTE — **CAUTION** — MOS devices are susceptible to damage from electrostatic charge. Reasonable precautions in handling and packaging MOS devices should be observed.

The RF MOSFET Line 80W, 175MHz, 28V

Rev. V1

ELECTRICAL CHARACTERISTICS — continued ($T_C = 25^\circ\text{C}$ unless otherwise noted)

Characteristic	Symbol	Min	Typ	Max	Unit
----------------	--------	-----	-----	-----	------

DYNAMIC CHARACTERISTICS

Input Capacitance ($V_{DS} = 28\text{ V}$, $V_{GS} = 0\text{ V}$, $f = 1.0\text{ MHz}$)	C_{iss}	—	110	—	pF
Output Capacitance ($V_{DS} = 28\text{ V}$, $V_{GS} = 0\text{ V}$, $f = 1.0\text{ MHz}$)	C_{oss}	—	105	—	pF
Reverse Transfer Capacitance ($V_{DS} = 28\text{ V}$, $V_{GS} = 0\text{ V}$, $f = 1.0\text{ MHz}$)	C_{rss}	—	10	—	pF

FUNCTIONAL CHARACTERISTICS

Noise Figure ($V_{DD} = 28\text{ V}$, $f = 150\text{ MHz}$, $I_{DQ} = 50\text{ mA}$)	NF	—	1.5	—	dB
Common Source Power Gain ($V_{DD} = 28\text{ V}$, $P_{out} = 80\text{ W}$, $f = 150\text{ MHz}$, $I_{DQ} = 50\text{ mA}$)	G_{ps}	11	13	—	dB
Drain Efficiency ($V_{DD} = 28\text{ V}$, $P_{out} = 80\text{ W}$, $f = 150\text{ MHz}$, $I_{DQ} = 50\text{ mA}$)	η	55	60	—	%
Electrical Ruggedness ($V_{DD} = 28\text{ V}$, $P_{out} = 80\text{ W}$, $f = 150\text{ MHz}$, $I_{DQ} = 50\text{ mA}$) Load VSWR 30:1 at all phase angles	ψ	No Degradation in Output Power			
Series Equivalent Input Impedance ($V_{DD} = 28\text{ V}$, $P_{out} = 80\text{ W}$, $f = 150\text{ MHz}$, $I_{DQ} = 50\text{ mA}$)	Z_{in}	—	1.35-j5.15	—	Ohms
Series Equivalent Output Impedance ($V_{DD} = 28\text{ V}$, $P_{out} = 80\text{ W}$, $f = 150\text{ MHz}$, $I_{DQ} = 50\text{ mA}$)	Z_{out}	—	2.72-j149	—	Ohms

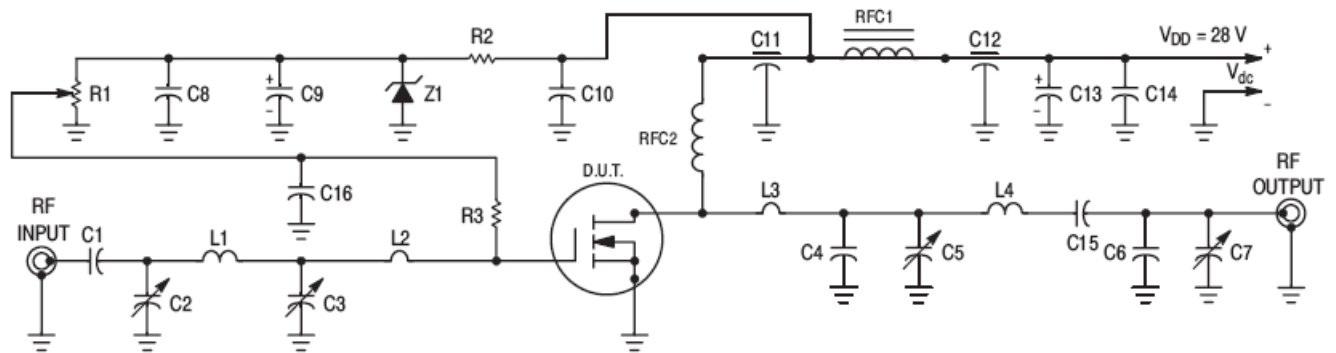

- | | |
|--|--|
| C1, C15 — 470 pF Unelco | L3 — #14 AWG Hairpin 0.8" long \rightarrow |
| C2, C3, C5 — 9–180 pF, Arco 463 | L4 — #14 AWG Hairpin 1.1" long \rightarrow |
| C4, C6 — 15 pF, Unelco | RFC1 — Ferroxcube VK200–19/4B |
| C7 — 5–80 pF, Arco 462 | RFC2 — 18 Turns #18 AWG Enameled, 0.3" ID |
| C8, C10, C14, C16 — 0.1 μ F | R1 — 10 k Ω , 10 Turns Bourns |
| C9, C13 — 50 μ F, 50 Vdc | R2 — 1.8 k Ω , 1/4 W |
| C11, C12 — 680 pF, Feed Through | R3 — 10 k Ω , 1/2 W |
| L1 — #16 AWG, 1–1/4 Turns, 0.3" ID | Z1 — 1N5925A Motorola Zener |
| L2 — #16 AWG Hairpin 1" long \rightarrow | |

Figure 1. 150 MHz Test Circuit

TYPICAL CHARACTERISTICS

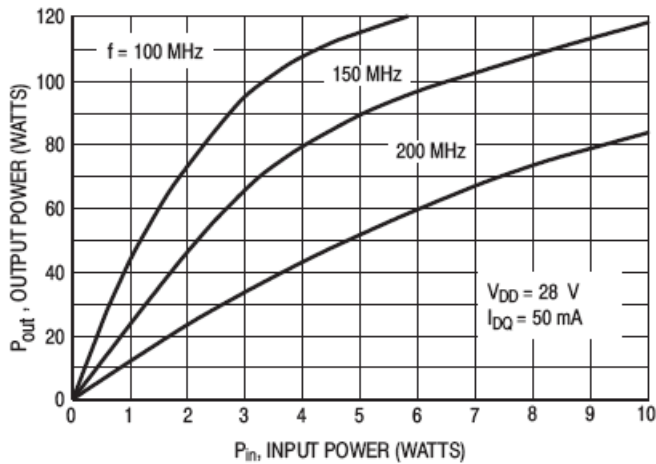

Figure 2. Output Power versus Input Power

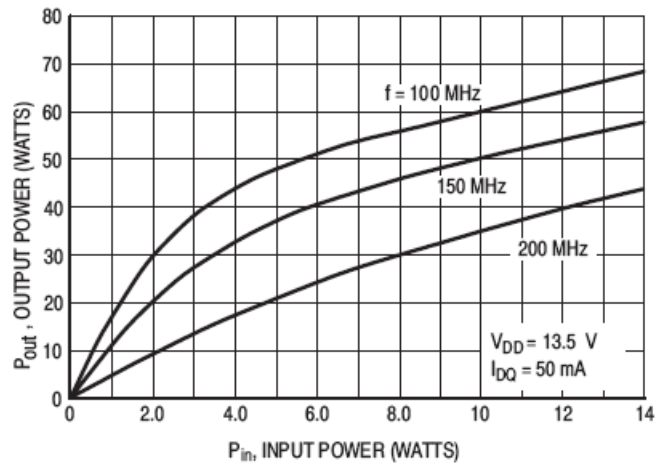

Figure 3. Output Power versus Input Power

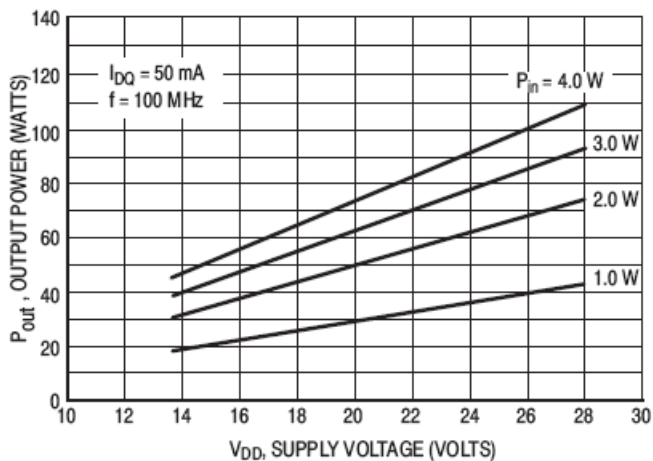

Figure 4. Output Power versus Supply Voltage

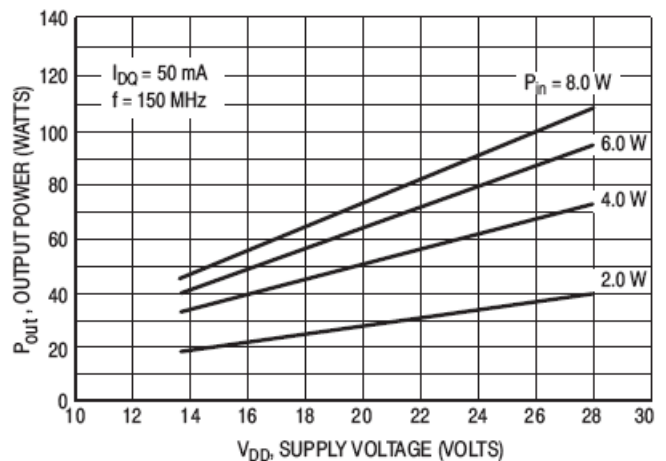

Figure 5. Output Power versus Supply Voltage

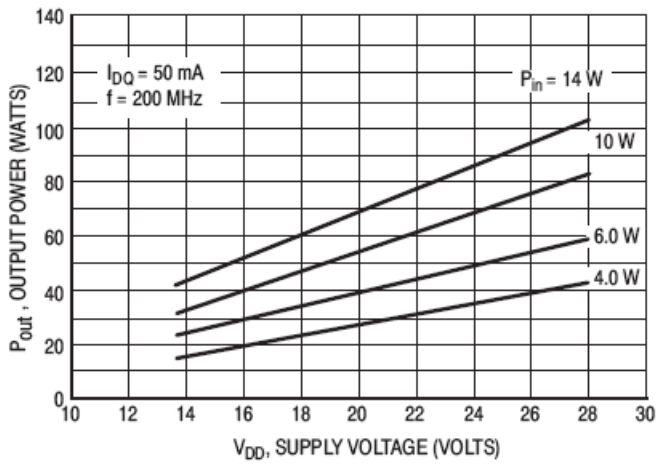

Figure 6. Output Power versus Supply Voltage

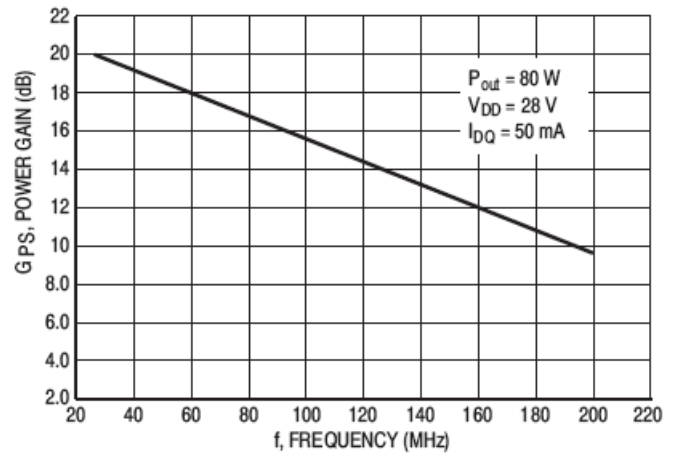

Figure 7. Power Gain versus Frequency

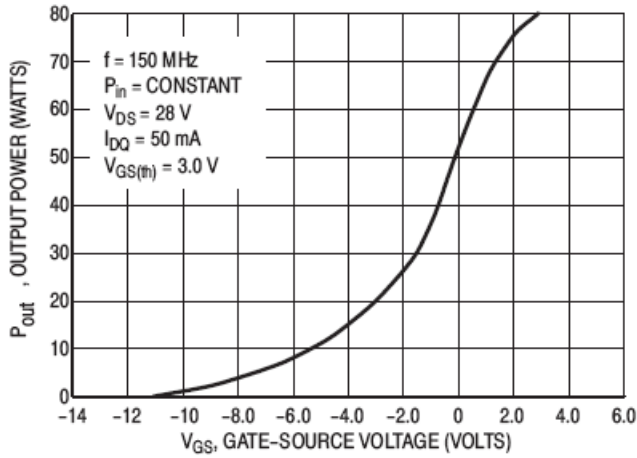

Figure 8. Output Power versus Gate Voltage

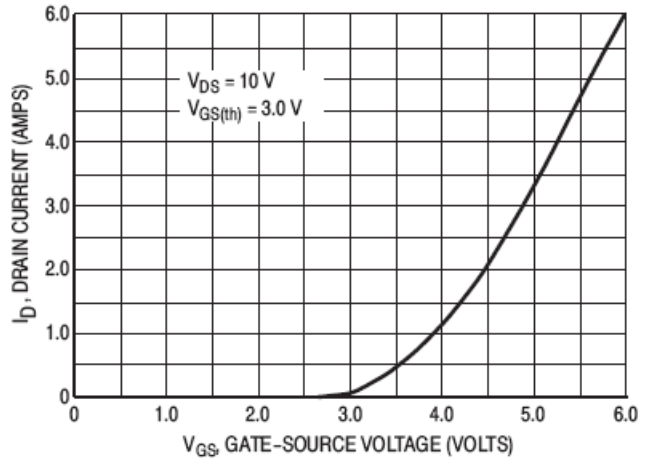

Figure 9. Drain Current versus Gate Voltage

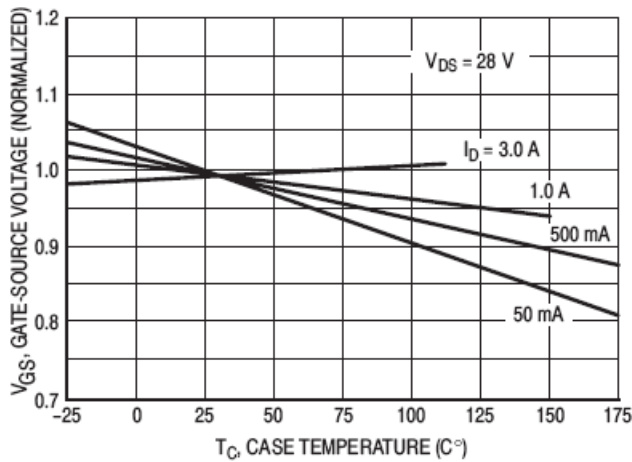

Figure 10. Gate-Source Voltage versus Case Temperature

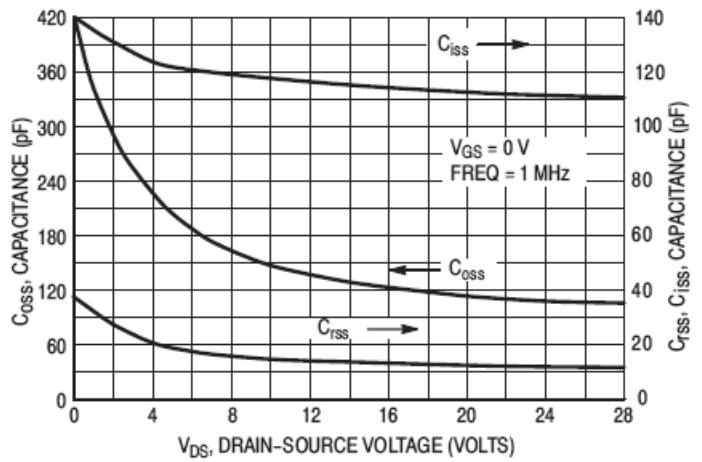

Figure 11. Capacitance versus Drain Voltage

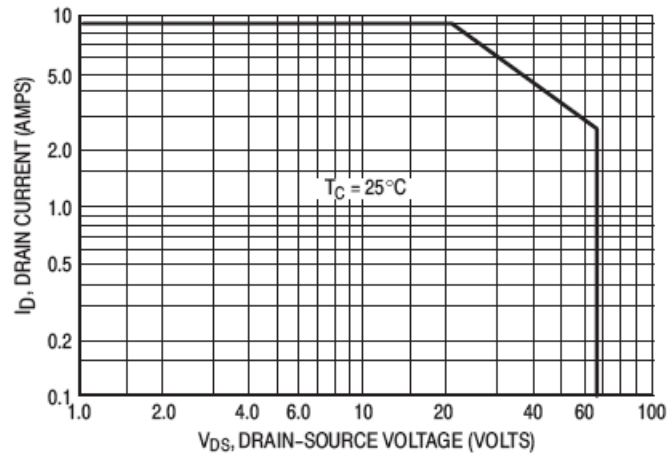

Figure 12. DC Safe Operating Area

DESIGN CONSIDERATIONS

The MRF173CQ is a RF MOSFET power N-channel enhancement mode field-effect transistor (FET) designed for VHF power amplifier applications. M/A-COM RF MOSFETs feature a vertical structure with a planar design, thus avoiding the processing difficulties associated with V-groove power FETs.

M/A-COM Application Note AN211A, FETs in Theory and Practice, is suggested reading for those not familiar with the construction and characteristics of FETs.

The major advantages of RF power FETs include high gain, low noise, simple bias systems, relative immunity from thermal runaway, and the ability to withstand severely mismatched loads without suffering damage. Power output can be varied over a wide range with a low power dc control signal, thus facilitating manual gain control, ALC and modulation.

DC BIAS

The MRF173CQ is an enhancement mode FET and, therefore, does not conduct when drain voltage is applied. Drain current flows when a positive voltage is applied to the gate. See Figure 9 for a typical plot of drain current versus gate voltage. RF power FETs require forward bias for optimum performance. The value of quiescent drain current (IDQ) is not critical for many applications. The MRF173CQ was characterized at IDQ = 50 mA, which is the suggested

minimum value of IDQ. For special applications such as linear amplification, IDQ may have to be selected to optimize the critical parameters.

The gate is a dc open circuit and draws no current. Therefore, the gate bias circuit may generally be just a simple resistive divider network. Some special applications may require a more elaborate bias system.

GAIN CONTROL

Power output of the MRF173CQ may be controlled from its rated value down to zero (negative gain) by varying the dc gate voltage. This feature facilitates the design of manual gain control, AGC/ALC and modulation systems. (see Figure 8.)

AMPLIFIER DESIGN

Impedance matching networks similar to those used with bipolar VHF transistors are suitable for MRF173CQ. See M/A-COM Application Note AN721, Impedance Matching Networks Applied to RF Power Transistors. The higher input impedance of RF MOSFETs helps ease the task of broadband network design. Both small-signal scattering parameters and large-signal impedances are provided. While the s-parameters will not produce an exact design solution for high power operation, they do yield a good first approximation. This is an additional advantage of RF MOS power FETs.

PACKAGE DIMENSIONS

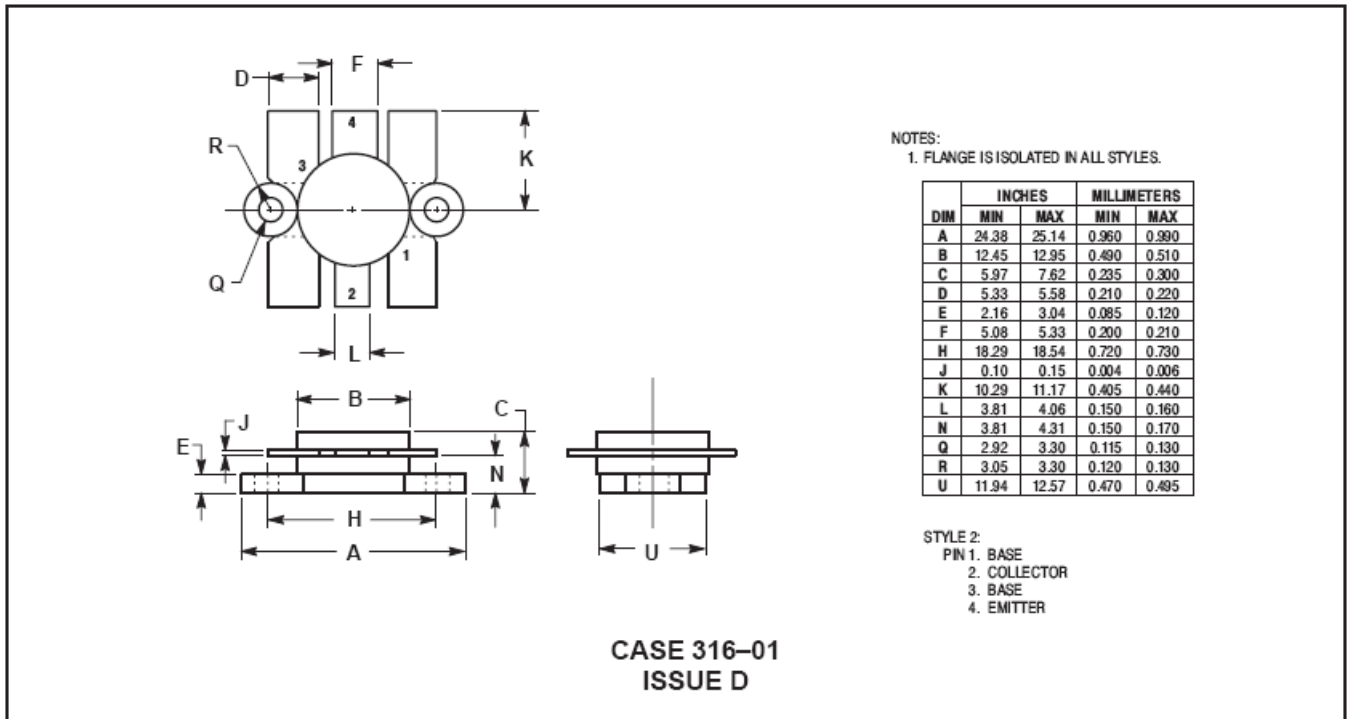

M/A-COM Technology Solutions Inc. All rights reserved.

Information in this document is provided in connection with M/A-COM Technology Solutions Inc ("MACOM") products. These materials are provided by MACOM as a service to its customers and may be used for informational purposes only. Except as provided in MACOM's Terms and Conditions of Sale for such products or in any separate agreement related to this document, MACOM assumes no liability whatsoever. MACOM assumes no responsibility for errors or omissions in these materials. MACOM may make changes to specifications and product descriptions at any time, without notice. MACOM makes no commitment to update the information and shall have no responsibility whatsoever for conflicts or incompatibilities arising from future changes to its specifications and product descriptions. No license, express or implied, by estoppel or otherwise, to any intellectual property rights is granted by this document.

THESE MATERIALS ARE PROVIDED "AS IS" WITHOUT WARRANTY OF ANY KIND, EITHER EXPRESS OR IMPLIED, RELATING TO SALE AND/OR USE OF MACOM PRODUCTS INCLUDING LIABILITY OR WARRANTIES RELATING TO FITNESS FOR A PARTICULAR PURPOSE, CONSEQUENTIAL OR INCIDENTAL DAMAGES, MERCHANTABILITY, OR INFRINGEMENT OF ANY PATENT, COPYRIGHT OR OTHER INTELLECTUAL PROPERTY RIGHT. MACOM FURTHER DOES NOT WARRANT THE ACCURACY OR COMPLETENESS OF THE INFORMATION, TEXT, GRAPHICS OR OTHER ITEMS CONTAINED WITHIN THESE MATERIALS. MACOM SHALL NOT BE LIABLE FOR ANY SPECIAL, INDIRECT, INCIDENTAL, OR CONSEQUENTIAL DAMAGES, INCLUDING WITHOUT LIMITATION, LOST REVENUES OR LOST PROFITS, WHICH MAY RESULT FROM THE USE OF THESE MATERIALS.

MACOM products are not intended for use in medical, lifesaving or life sustaining applications. MACOM customers using or selling MACOM products for use in such applications do so at their own risk and agree to fully indemnify MACOM for any damages resulting from such improper use or sale.