

# SPDT Reflective Switch

## DC - 44 GHz



MASW-011197

Rev. V1

### Features

- Ultra Wideband: 9 kHz to 44 GHz
- Insertion Loss:
  - 0.8 dB @ 15 GHz
  - 1.0 dB @ 30 GHz
  - 1.4 dB @ 44 GHz
- Isolation:
  - 48 dB @ 15 GHz
  - 46 dB @ 30 GHz
  - 46 dB @ 44 GHz
- Input P1dB: 28 dBm
- Input IP3: 52 dBm
- Return Loss at Each RF Port: 18 dB
- Power Handling Including Hot Switching: 26 dBm
- No Low Frequency Spurious
- Compatible with 1.8, 2.5, and 3.3 V CMOS Logic
- 2.25 mm, 12 Lead Laminate Package
- RoHS\* Compliant

### Applications

- Multi Market
- ISM

### Description

The MASW-011197 is a reflective, ultra wideband single pole double throw (SPDT) switch with 1.4 dB of insertion loss at 44 GHz. The power handling capability is 26 dBm. The input and output return losses in the thru path are typically 18 dB. The logic levels are compatible with standard 1.8, 2.5, or 3.3 V CMOS. Required bias supplies are +3.3 V & -3.3 V.

The MASW-011197 is designed for wideband applications such as Test and Measurement, Aerospace and Defense, Cellular infrastructure (5G millimeter-wave), military radios, radars, microwave radios and very small aperture terminals (VSATs).

The MASW-011197 is manufactured on a Silicon-on-Insulator process. The 2.25 mm laminate package is lead free and RoHS compliant.

### Functional Schematic

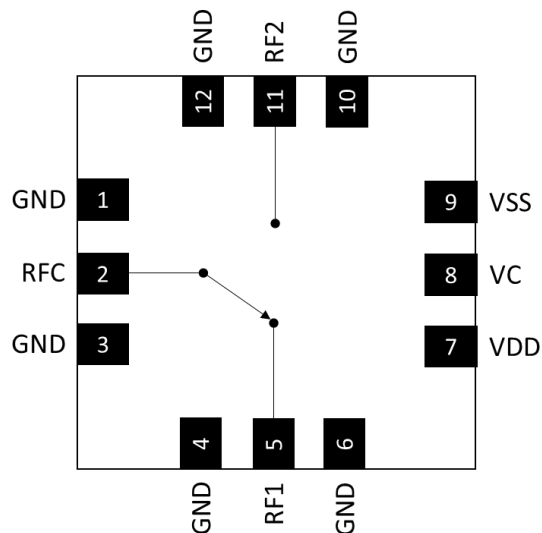

### Pin Configuration<sup>1</sup>

Pin #	Pin Name	Description
1,3,4,6,10,12	GND	Ground
2	RFC <sup>2</sup>	Common RF Input/Output
5	RF1 <sup>2</sup>	RF Input/Output 1
7	VDD	+3.3 V
8	VC	Control Voltage
9	VSS	-3.3 V
11	RF2 <sup>2</sup>	RF Input/Output 2

1. The exposed pad centered on the package bottom must be connected to RF, DC and thermal ground.
2. RF ports are dc-coupled to GND. There are no internal DC blocking capacitors.

### Ordering Information<sup>3,4</sup>

Part Number	Package
MASW-011197-TR0500	500 Piece reel
MASW-011197-SMB	Sample Board

3. Reference Application Note M513 for reel size information.
4. All sample boards include 3 loose parts.

<sup>1</sup> \* Restrictions on Hazardous Substances, compliant to current RoHS EU directive.

# SPDT Reflective Switch

## DC - 44 GHz



MASW-011197

Rev. V1

### Electrical Specifications<sup>5</sup>:

$V_{DD} = +3.3\text{ V}$ ,  $V_{SS} = -3.3\text{ V}$ ,  $V_C = 0\text{ V}$  or  $1.8\text{ V}$ ,  $T_{PADDLE} = 25^{\circ}\text{C}$ ,  $Z_0 = 50\ \Omega$

Parameter	Test Conditions	Units	Min.	Typ.	Max.
Insertion Loss	DC to 15 GHz	dB	—	0.7	—
	15 GHz			0.8	1.3
	30 GHz			1.0	1.7
	44 GHz			1.4	2.5
Isolation, Between RF1 to RF2	DC to 15 GHz	dB	—	50	—
	15 GHz		—	48	
	30 GHz		—	46	
	44 GHz		—	46	
Isolation, RFC to RF1 / RF2	DC to 15 GHz	dB	—	60	—
	15 GHz		44	46	
	30 GHz		41	45	
	44 GHz		36	42	
RFC Port Return Loss	DC - 44 GHz	dB	—	18	—
RF1 / RF2 Port Return Losses	DC - 44 GHz	dB	—	18	—
Input P0.1dB	10 MHz - 44 GHz	dBm	—	27	—
Input P1dB	10 MHz - 44 GHz	dBm	—	28	—
Input IP3	Two tone, $P_{IN}/\text{tone} = +14\text{ dBm}$ 10 MHz - 44 GHz	dBm	—	52	—
$T_{ON}$	50% control to 90% RF	$\mu\text{s}$	—	0.71	—
$T_{RISE}$	10% to 90% RF	$\mu\text{s}$	—	0.26	—
$T_{OFF}$	50% control to 10% RF	$\mu\text{s}$	—	0.25	—
$T_{FALL}$	90% to 10% RF	$\mu\text{s}$	—	0.13	—
Voltage Supply, VDD	—	V	3.15	3.3	3.45
Voltage Supply, VSS	—	V	-3.45	-3.3	-3.15
Logic Voltage, Input Low ( $V_{IL}$ )	—	V	0.0	—	0.8
Logic Voltage, Input High ( $V_{IH}$ )	—	V	1.2	—	VDD
Supply Current, VDD	—	mA	—	0.35	0.5
Supply Current, VSS	—	mA	—	0.7	1.0
Logic Pin Current (VC)	Pulled down to GND with 100 k $\Omega$ resistor	$\mu\text{A}$	—	VC*10	—

5. Device shall be aligned to recommended PCB footprint within +/- 1 mil for optimum performance.

# SPDT Reflective Switch DC - 44 GHz



MASW-011197

Rev. V1

## Maximum Operating Conditions

Parameter	Maximum
Input Power, 300 MHz to 44 GHz, RFC Port <sup>6</sup> RF1 / RF2 Port <sup>6</sup>	26 dBm 26 dBm
VDD	-0.3 to +3.45 V
VSS	-3.45 to +0.3 V
VC	-0.3 to 3.45 V
Operating Temperature <sup>7</sup>	-40 to +105°C

6.  $T_{\text{PADDLE}} = 105^{\circ}\text{C}$ . See power derating curves for details.

7. Guarantees 10 years lifetime.

## Low Frequency Power Derating Detail<sup>6</sup>

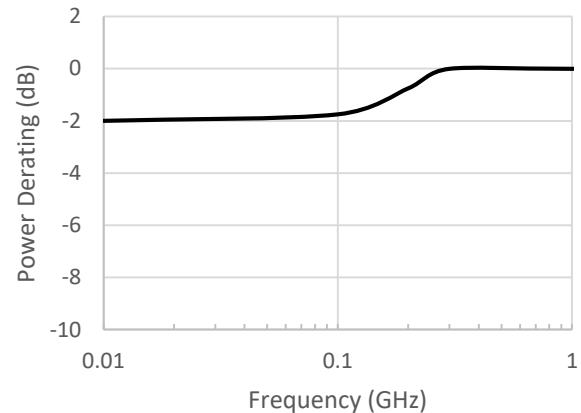

## Absolute Maximum Ratings<sup>8,9,10</sup>

Parameter	Absolute Maximum
Input Power, 300 MHz to 44 GHz, RFC Port <sup>6</sup> RF1 / RF2 Port <sup>6</sup>	27 dBm 27 dBm
VDD	-0.3 to +3.6 V
VSS	-3.6 to +0.3 V
VC	-0.3 to 3.6 V
Junction Temperature	+135°C

8. Exceeding any one or combination of these limits may cause permanent damage to this device.

9. MACOM does not recommend sustained operation near these survivability limits.

10. Based on testing with input power applied for 30 seconds.

## Handling Procedures

Please observe the following precautions to avoid damage:

## Static Sensitivity

These electronic devices are sensitive to electrostatic discharge (ESD) and can be damaged by static electricity. Proper ESD control techniques should be used when handling these devices.

## Truth Table

Control Input	Condition of Switch	
	RFC - RF1 Path	RFC - RF2 Path
$V_{\text{IH}}$	On	Off
$V_{\text{IL}}$	Off	On

Parameter	Rating	Standard
Human Body Model (HBM)	Class 1C	ESDA/JEDEC JS-001
Charged Device Model (CDM)	Class C3	ESDA/JEDEC JS-002

**Application Schematic**

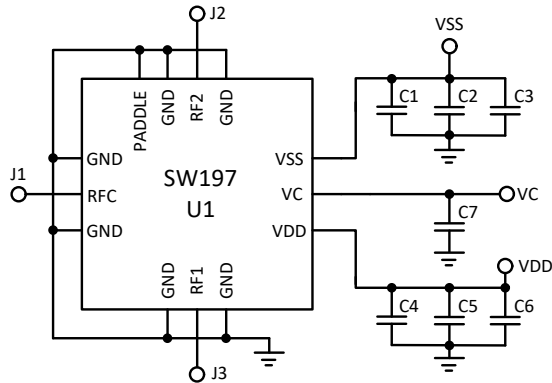

**Recommended PCB Footprint**

MASW-011197-SMB is a 2-layer board with 8 mil Rogers RO4003 dielectric material and 1 oz copper on top and bottom layers. For this stack-up, the recommended PCB footprint is shown below.

The 50Ω RF transmission lines are CPWG of 14 mil width with 6.5 mil gap.

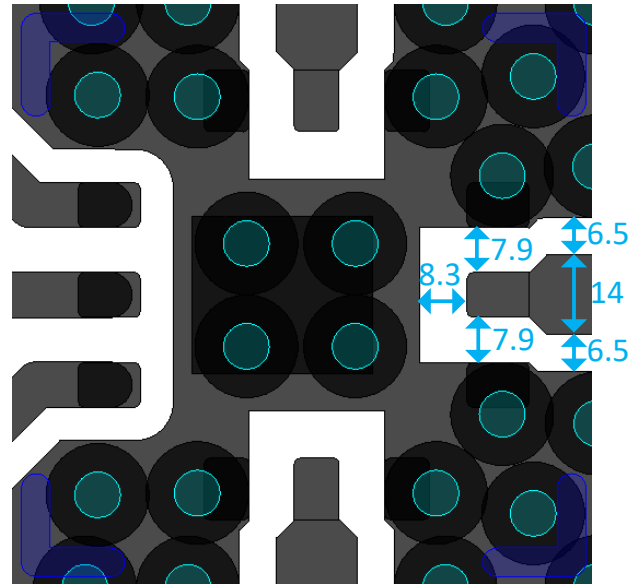

**Parts List**

Part	Value	Case Style
U1	MASW-011197	2.25 mm, 12 Lead
C1, C4	Capacitor, 10 pF, 50 V	0402
C2,C5	Capacitor, 1000 pF, 25 V	0402
C3, C6	Capacitor, 1 μF, 10 V	0402
J1 - J3	Southwest 1892-04A-6	End Launch
J4	DC Connector	Tyco Electronics 5-146130-1

**Evaluation Board Layout**

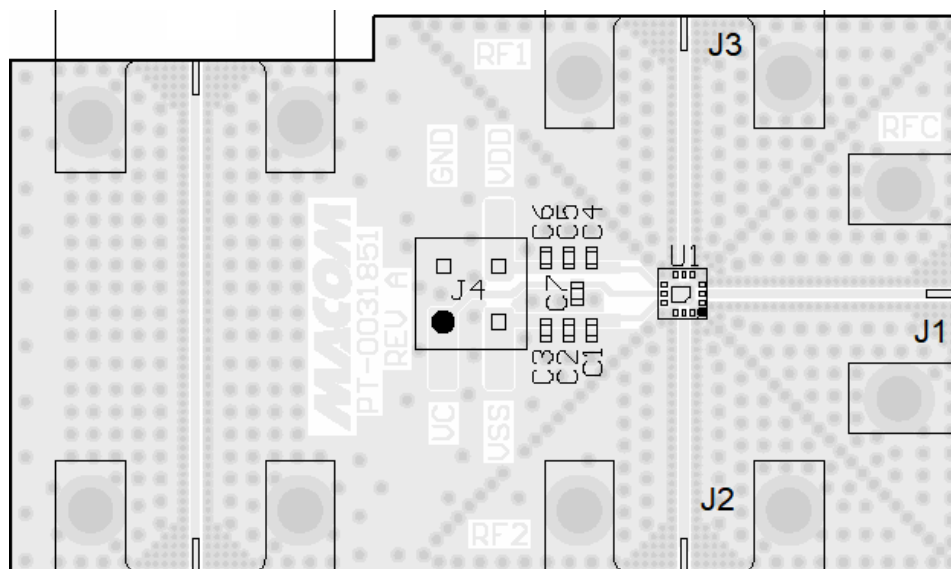

## Typical Performance Curves

**Insertion Loss<sup>11</sup>**

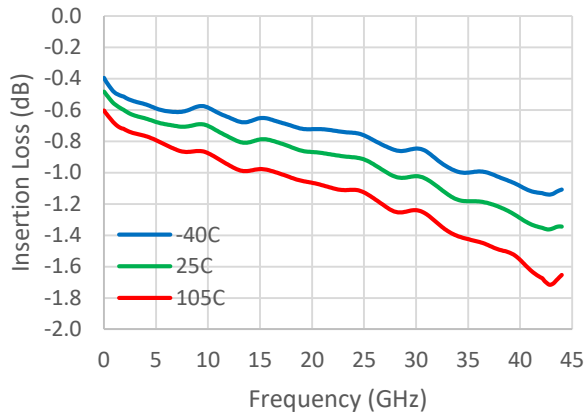

**RFC to RF1 / RF2 Isolation<sup>11</sup>**

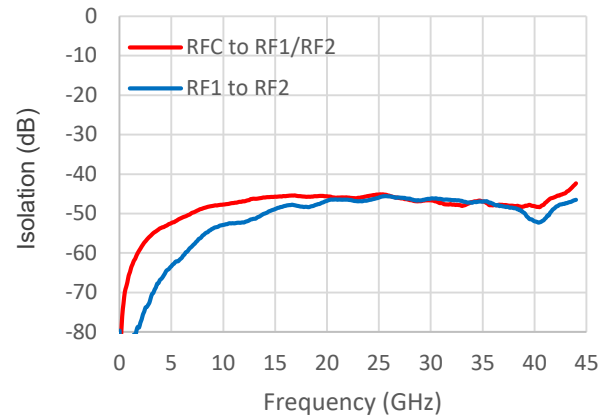

**RFC Return Loss<sup>12</sup>**

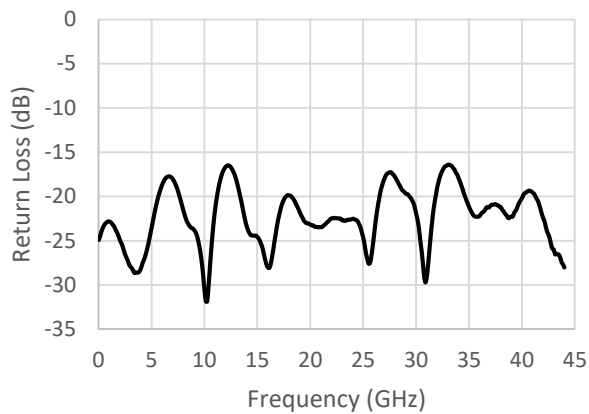

**RF1 / RF2 Return Loss<sup>12</sup>**

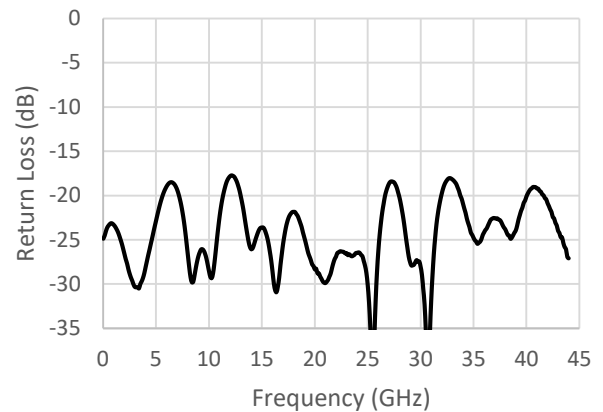

**Evaluation Board Thru Line Insertion Loss**

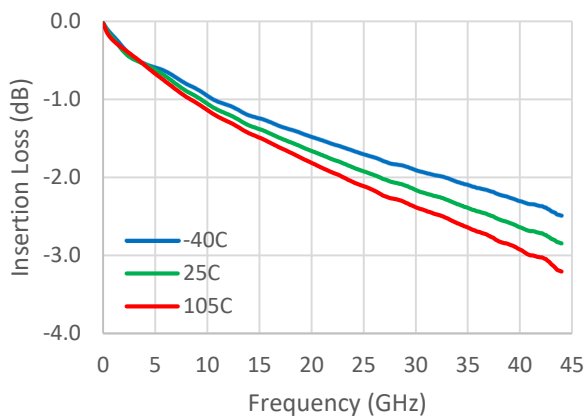

**Evaluation Board Thru Line Return Loss**

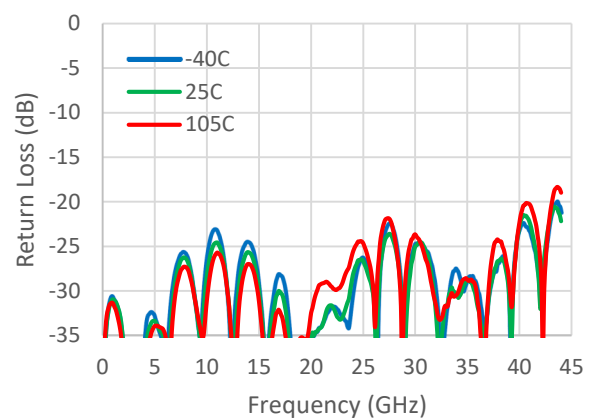

11. Insertion Loss and Isolation were measured using connectorized evaluation board, and normalized using the insertion loss of the 50 Ω thru line.

12. Return Loss were measured using connectorized evaluation board.

# SPDT Reflective Switch DC - 44 GHz



MASW-011197

Rev. V1

## Typical Performance Curves

Input P0.1dB

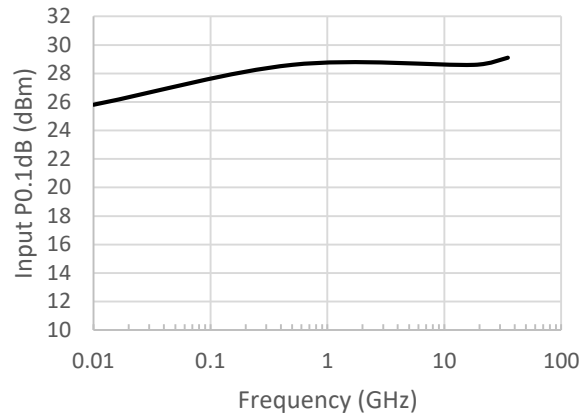

Input P1dB

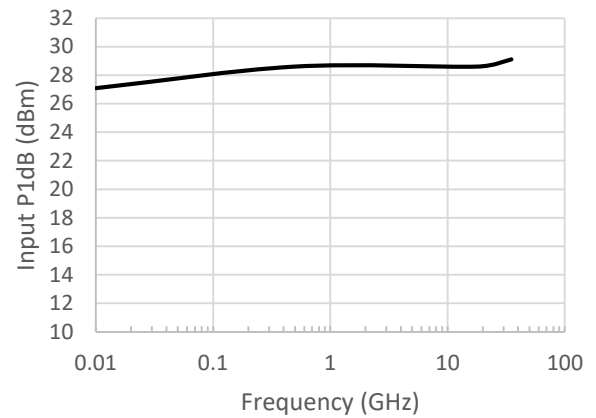

Input IP3<sup>13</sup>

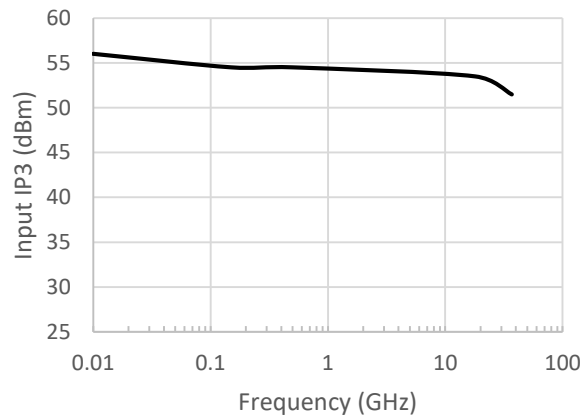

13. Input IP3 were measured using connectorized evaluation board. The RF input power was 14 dBm per tone with spacing of 1 MHz.

# SPDT Reflective Switch DC - 44 GHz



MASW-011197

Rev. V1

## Lead Free 2.25 mm 12-Lead Laminate Package †

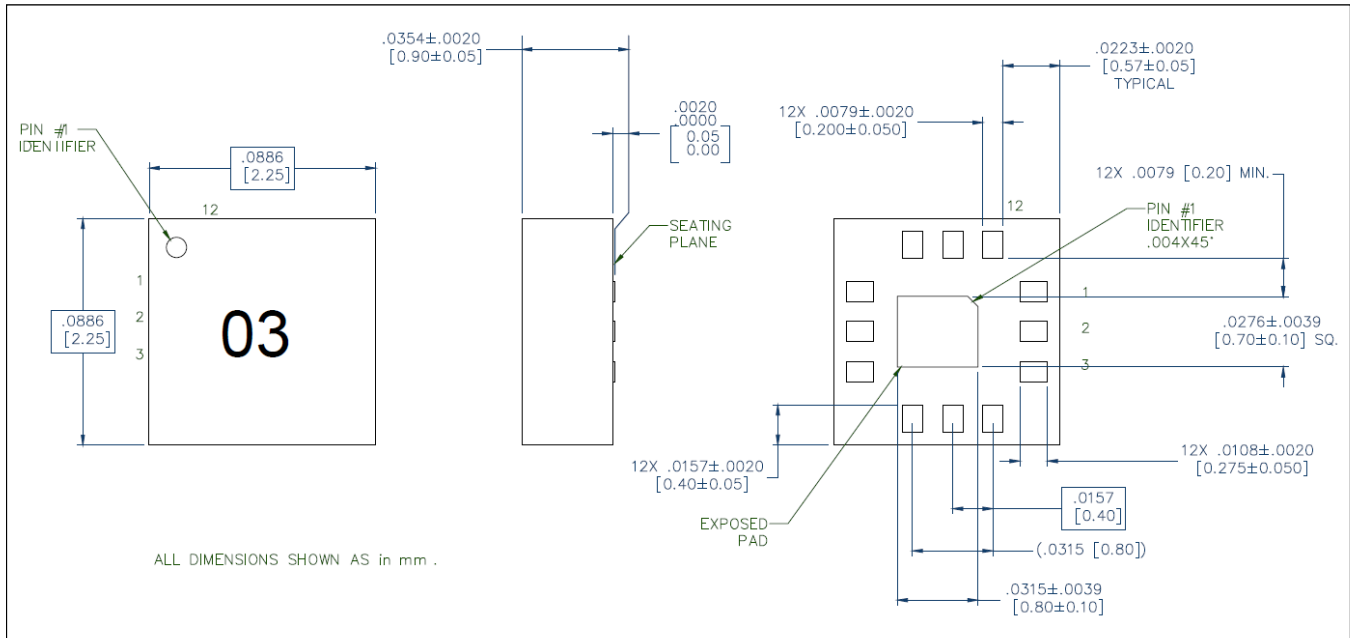

† Reference Application Note S2083 for lead-free solder reflow recommendations.  
Meets JEDEC moisture sensitivity level 3 requirements.  
Plating is ENEPIG Ni 3~9 μm / Pd 0.02~0.09 μm / Au 0.03 ~ 0.12 μm.

MACOM Technology Solutions Inc. ("MACOM"). All rights reserved.

These materials are provided in connection with MACOM's products as a service to its customers and may be used for informational purposes only. Except as provided in its Terms and Conditions of Sale or any separate agreement, MACOM assumes no liability or responsibility whatsoever, including for (i) errors or omissions in these materials; (ii) failure to update these materials; or (iii) conflicts or incompatibilities arising from future changes to specifications and product descriptions, which MACOM may make at any time, without notice. These materials grant no license, express or implied, to any intellectual property rights.

THESE MATERIALS ARE PROVIDED "AS IS" WITH NO WARRANTY OR LIABILITY, EXPRESS OR IMPLIED, RELATING TO SALE AND/OR USE OF MACOM PRODUCTS INCLUDING FITNESS FOR A PARTICULAR PURPOSE, MERCHANTABILITY, INFRINGEMENT OF INTELLECTUAL PROPERTY RIGHT, ACCURACY OR COMPLETENESS, OR SPECIAL, INDIRECT, INCIDENTAL, OR CONSEQUENTIAL DAMAGES WHICH MAY RESULT FROM USE OF THESE MATERIALS.

MACOM products are not intended for use in medical, lifesaving or life sustaining applications. MACOM customers using or selling MACOM products for use in such applications do so at their own risk and agree to fully indemnify MACOM for any damages resulting from such improper use or sale.