

SPDT Reflective Switch DC - 67 GHz



MASW-011151

Rev. V1

Features

- Ultra Wideband: 9 kHz to 67 GHz
- Insertion Loss:
 - 1.3 dB @ 40 GHz
 - 1.7 dB @ 55 GHz
 - 3.0 dB @ 67 GHz
- Isolation:
 - 45 dB @ 40 GHz
 - 36 dB @ 55 GHz
 - 33 dB @ 67 GHz
- Input P1dB: 27.5 dBm
- Input IP3: 52 dBm
- Return Loss at Each RF Port: 16 dB
- Power Handling Including Hot Switching: 26 dBm
- No Low Frequency Spurious
- Compatible with 1.8, 2.5, and 3.3V CMOS Logic
- 2.25 mm, 12 Lead Laminate Package
- RoHS* Compliant

Applications

- Test & Measurement
- ISM, Multi Market

Description

The MASW-011151 is a reflective, ultra wideband single pole double throw (SPDT) switch with 1.7 dB of insertion loss at 55 GHz. The power handling capability is 26 dBm. The input and output return losses in the thru path are typically 16 dB. The logic levels are compatible with standard 1.8, 2.5, or 3.3 V CMOS. Required bias supplies are +3.3 V & -3.3 V.

For ultra wideband applications, impedance matching on the RF transmission lines can further optimize high frequency insertion loss and return loss performance.

The MASW-011151 is designed for wideband applications such as Test and Measurement, Aerospace and Defense, Cellular infrastructure (5G millimeter-wave), military radios, radars, microwave radios and very small aperture terminals (VSATs).

The MASW-011151 is manufactured on a Silicon-on-Insulator process. The 2.25 mm laminate package is lead free and RoHS compliant.

Functional Schematic

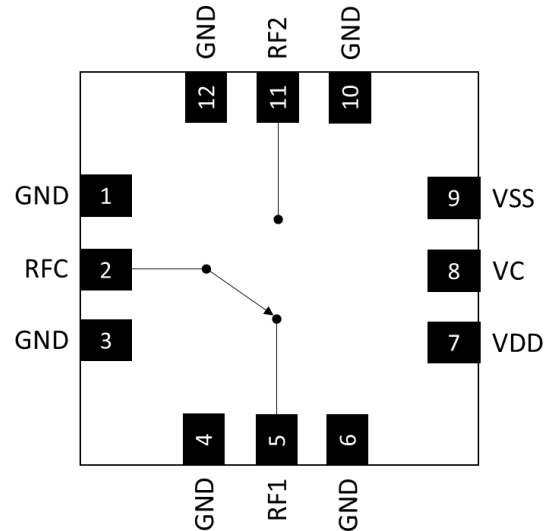

Pin Configuration¹

Pin #	Pin Name	Description
1,3,4,6,10,12	GND	Ground
2	RFC ²	Common RF Input/Output
5	RF1 ²	RF Input/Output 1
7	VDD	+3.3 V
8	VC	Control Voltage
9	VSS	-3.3 V
11	RF2 ²	RF Input/Output 2

1. The exposed pad centered on the package bottom must be connected to RF, DC and thermal ground.
2. RF ports are dc-coupled to GND. There are no internal DC blocking capacitors.

Ordering Information^{3,4}

Part Number	Package
MASW-011151-TR0500	500 Piece reel
MASW-011151-SMB	Sample Board

3. Reference Application Note M513 for reel size information.
4. All sample boards include 3 loose parts.

¹ * Restrictions on Hazardous Substances, compliant to current RoHS EU directive.

SPDT Reflective Switch

DC - 67 GHz



MASW-011151

Rev. V1

Electrical Specifications⁵:

$V_{DD} = +3.3 \text{ V}$, $V_{SS} = -3.3 \text{ V}$, $V_C = 0 \text{ V or } 1.8 \text{ V}$, $T_{PADDLE} = 25^\circ\text{C}$, $Z_0 = 50 \Omega$

Parameter	Test Conditions	Units	Min.	Typ.	Max.
Insertion Loss	DC to 18 GHz	dB	—	0.8	—
	19 GHz			0.9	1.5
	26 GHz			1.1	—
	38 GHz			1.3	2.0
	52 GHz			1.7	2.5
	67 GHz			3.0	—
Isolation, Between RF1 to RF2	DC to 18 GHz	dB	—	50	—
	19 GHz		44	49	
	26 GHz		—	47	
	38 GHz		41	50	
	52 GHz		33	36	
	67 GHz		—	33	
Isolation, RFC to RF1 / RF2	DC to 18 GHz	dB	—	47	—
	19 GHz		44	47	
	26 GHz		—	47	
	38 GHz		41	45	
	52 GHz		33	36	
	67 GHz		—	33	
RFC Port Return Loss	DC - 67 GHz	dB	—	16	—
RF1 / RF2 Port Return Losses	DC - 67 GHz	dB	—	16	—
Input P0.1dB	10 MHz - 67 GHz	dBm	—	26.5	—
Input P1dB	10 MHz - 67 GHz	dBm	—	27.5	—
Input IP3	Two tone, $P_{IN}/\text{tone} = +12 \text{ dBm}$ 10 MHz - 67 GHz	dBm	—	52	—
T_{ON}	50% control to 90% RF	μs	—	0.71	—
T_{RISE}	10% to 90% RF	μs	—	0.26	—
T_{OFF}	50% control to 10% RF	μs	—	0.25	—
T_{FALL}	90% to 10% RF	μs	—	0.13	—
Voltage Supply, VDD	—	V	3.15	3.3	3.45
Voltage Supply, VSS	—	V	-3.45	-3.3	-3.15
Logic Voltage, Input Low (V_{IL})	—	V	0.0	—	0.8
Logic Voltage, Input High (V_{IH})	—	V	1.2	—	VDD
Supply Current, VDD	—	mA	—	0.35	0.5
Supply Current, VSS	—	mA	—	0.7	1.0
Logic Pin Current (VC)	Pulled down to GND with 100 k Ω resistor	μA	—	VC*10	—

5. Parameters are measured on a test board that includes impedance matching. Device needs to be aligned to recommended PCB footprint +/- 1 mil for optimum performance.

SPDT Reflective Switch DC - 67 GHz



MASW-011151

Rev. V1

Maximum Operating Ratings

Parameter	Absolute Maximum
Input Power, 300 MHz to 40 GHz, RFC Port ⁶	26 dBm
Input Power, 300 MHz to 40 GHz, RF1 / RF2 Port ⁶	26 dBm
VDD	-0.3 to +3.45 V
VSS	-3.45 to +0.3 V
VC	-0.3 to 3.45 V
Operating Temperature ⁷	-40 to +105°C

6. T_{PADDLE} = 105 °C. See power derating curves for details.

7. Guarantees 10 years lifetime.

Power Derating Curve⁶

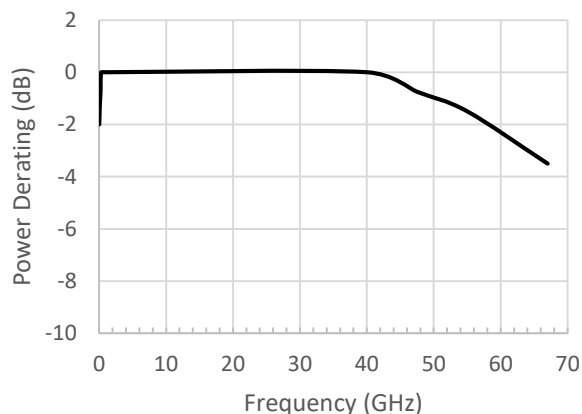

Absolute Maximum Ratings^{8,9,10}

Parameter	Absolute Maximum
Input Power, 300 MHz to 40 GHz, RFC Port ⁶	27 dBm
Input Power, 300 MHz to 40 GHz, RF1 / RF2 Port ⁶	27 dBm
VDD	-0.3 to +3.6 V
VSS	-3.6 to +0.3 V
VC	-0.3 to 3.6 V
Junction Temperature	+135°C

8. Exceeding any one or combination of these limits may cause permanent damage to this device.

9. MACOM does not recommend sustained operation near these survivability limits.

10. Based on testing with input power applied for 30 seconds.

Low Frequency Power Derating Detail⁶

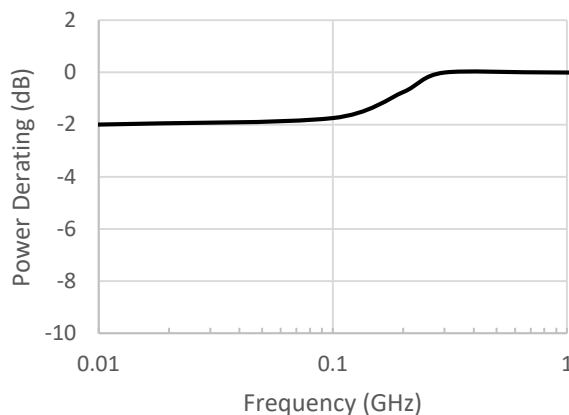

Truth Table

Control Input	Condition of Switch	
	RFC - RF1 Path	RFC - RF2 Path
V _{IH}	On	Off
V _{IL}	Off	On

Handling Procedures

Please observe the following precautions to avoid damage:

Static Sensitivity

These electronic devices are sensitive to electrostatic discharge (ESD) and can be damaged by static electricity. Proper ESD control techniques should be used when handling these devices.

Parameter	Rating	Standard
Human Body Model (HBM)	Class 1C	ESDA/JEDEC JS-001
Charged Device Model (CDM)	Class C3	ESDA/JEDEC JS-002

Application Schematic

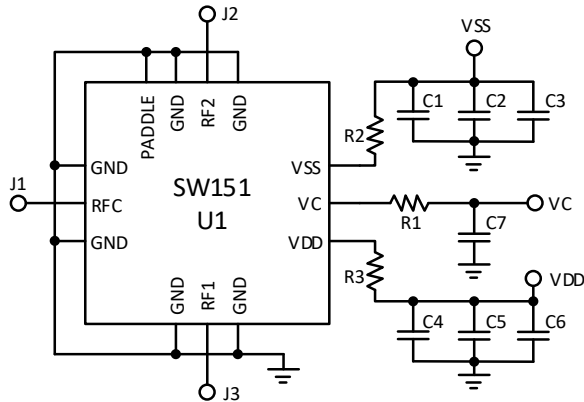

Impedance Match

MASW-011151-SMB is a 2-layer board with 8 mil Rogers RO4003 dielectric material and 1 oz copper on top and bottom layers. For this stack-up, 5 mil traces with 7 mil width are used for all RF port matching, as shown below.

The 50 Ω RF transmission lines are CPWG of 14 mil width with 6.5 mil gap.

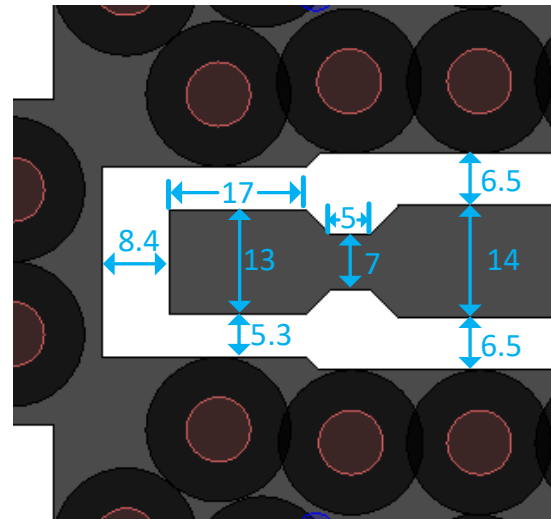

Parts List

Part	Value	Case Style
U1	MASW-011151	2.25mm, 12 Lead
C1, C4	Capacitor, 10 pF, 50 V	0402
C2, C5	Capacitor, 1000 pF, 25 V	0402
C3, C6	Capacitor, 1 μF, 10 V	0402
R1 - R3	Resistor, 0 Ω	0402
J1 - J3	Southwest 1892-04A-6	End Launch
J8	DC Connector	Tyco Electronics 5-146130-1

Evaluation Board Layout

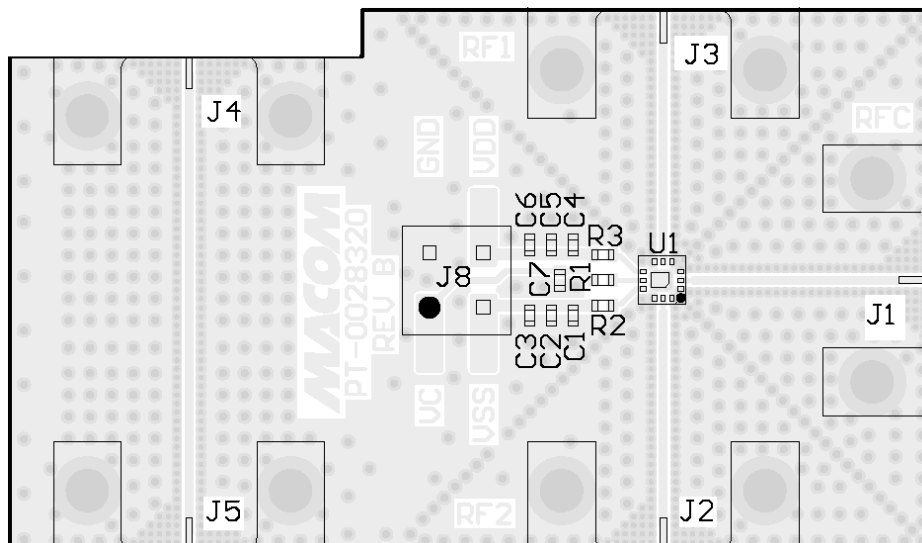

Typical Performance Curves

Insertion Loss with Impedance Match¹¹

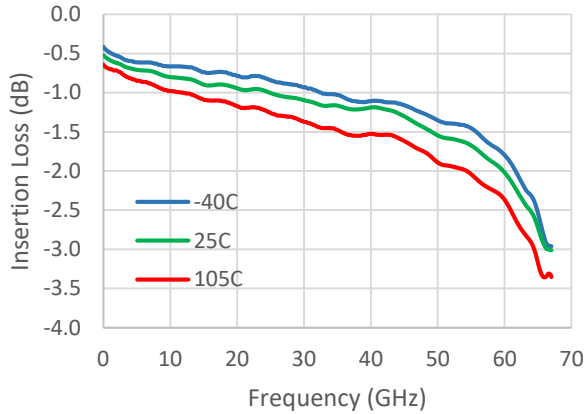

RFC to RF1 / RF2 Isolation with Impedance Match¹¹

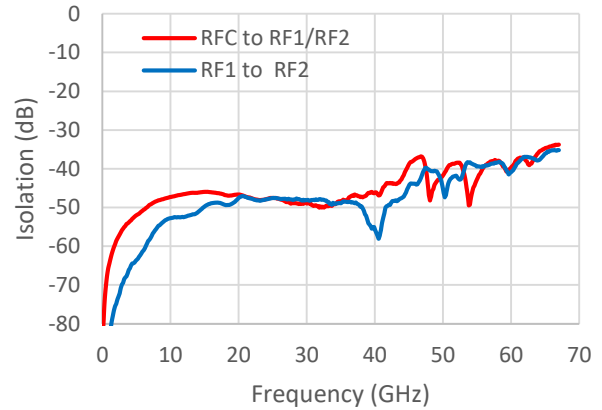

RFC Return Loss with Impedance Match¹²

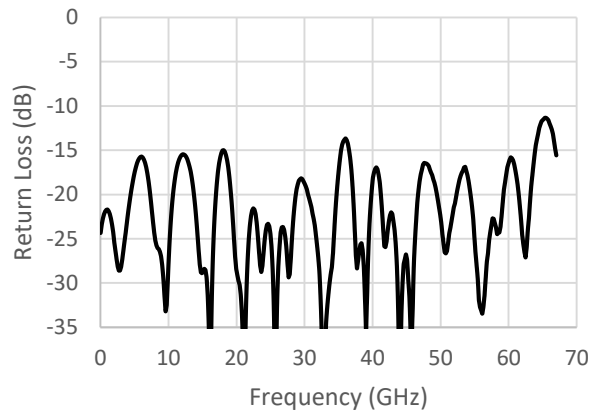

RF1 / RF2 Return Loss with Impedance Match¹²

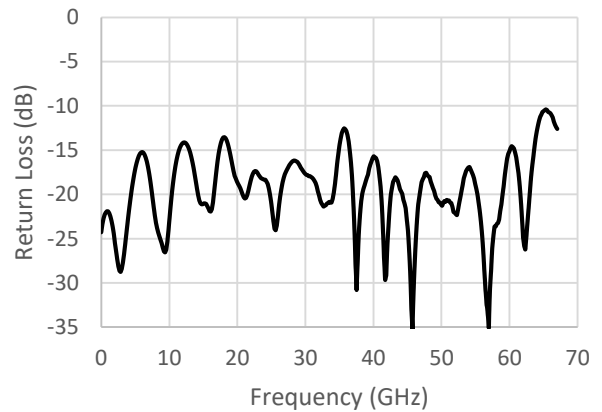

Evaluation Board Thru Line Insertion Loss

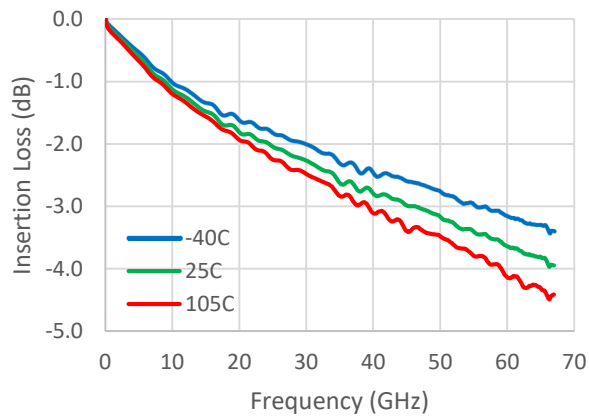

Evaluation Board Thru Line Return Loss

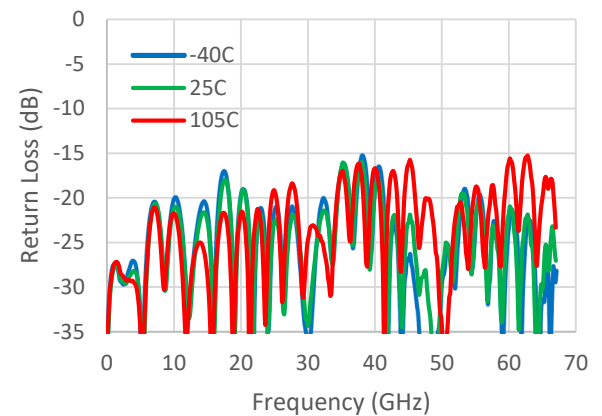

11. Insertion Loss and Isolation with impedance match were measured using connectorized evaluation board, and normalized using the insertion loss of the 50 Ω thru line.
12. Return Loss with impedance match were measured using connectorized evaluation board.

Typical Performance Curves

Input P0.1dB

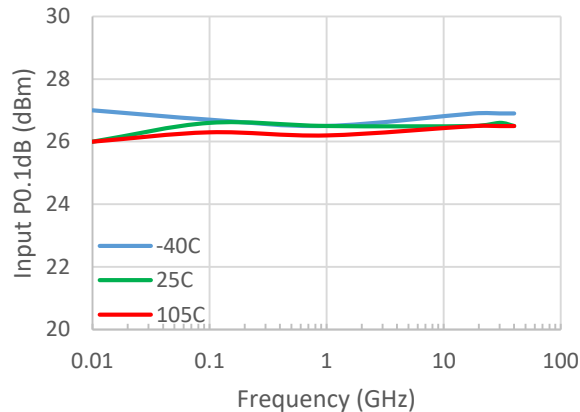

Input P1dB

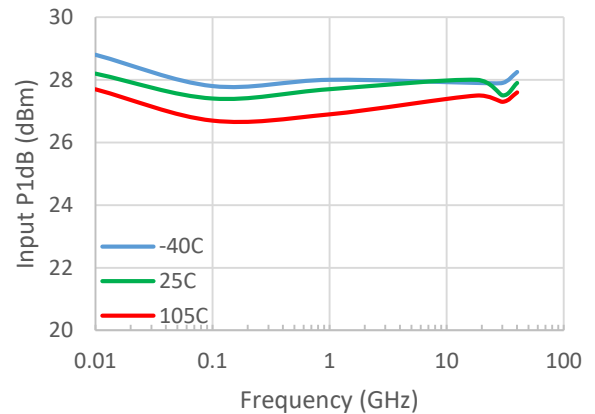

Input IP3¹³

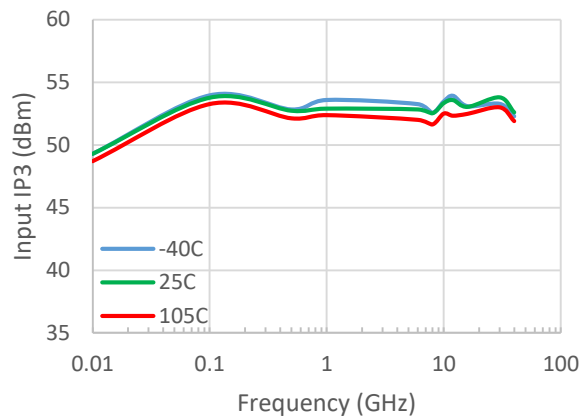

13. Input IP3 were measured using connectorized evaluation board with impedance matching. The RF input power was 12 dBm per tone with spacing of 10 MHz for frequency higher than 1 GHz, 5 MHz for frequency between 100 MHz and 1 GHz, and 1 MHz for frequencies lower than 100 MHz. The IP3 rolloff from 100 MHz to 10 MHz are due to rolloff of test system IP3.

SPDT Reflective Switch DC - 67 GHz



MASW-011151

Rev. V1

Lead Free 2.25 mm 12-Lead Laminate Package[†]

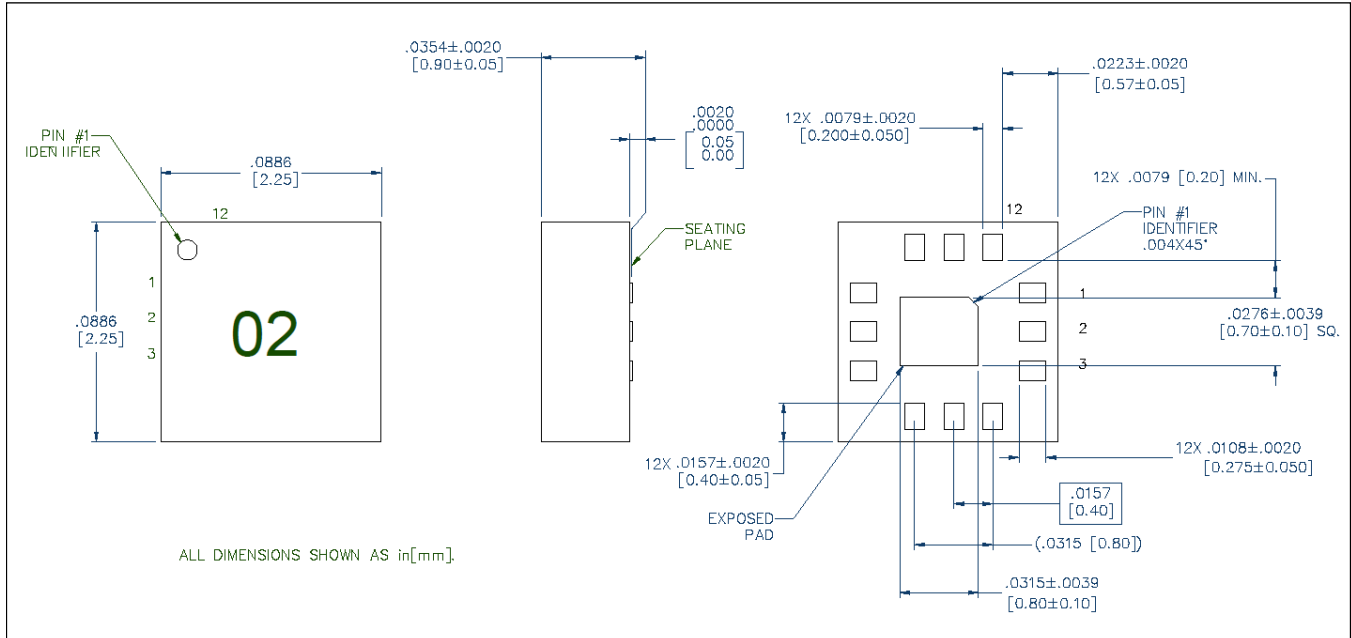

[†] Reference Application Note S2083 for lead-free solder reflow recommendations.
Meets JEDEC moisture sensitivity level 3 requirements.
Plating is ENEPIG Ni 3~9 μm / Pd 0.02~0.09 μm / Au 0.03 ~ 0.12 μm .

MACOM Technology Solutions Inc. ("MACOM"). All rights reserved.

These materials are provided in connection with MACOM's products as a service to its customers and may be used for informational purposes only. Except as provided in its Terms and Conditions of Sale or any separate agreement, MACOM assumes no liability or responsibility whatsoever, including for (i) errors or omissions in these materials; (ii) failure to update these materials; or (iii) conflicts or incompatibilities arising from future changes to specifications and product descriptions, which MACOM may make at any time, without notice. These materials grant no license, express or implied, to any intellectual property rights.

THESE MATERIALS ARE PROVIDED "AS IS" WITH NO WARRANTY OR LIABILITY, EXPRESS OR IMPLIED, RELATING TO SALE AND/OR USE OF MACOM PRODUCTS INCLUDING FITNESS FOR A PARTICULAR PURPOSE, MERCHANTABILITY, INFRINGEMENT OF INTELLECTUAL PROPERTY RIGHT, ACCURACY OR COMPLETENESS, OR SPECIAL, INDIRECT, INCIDENTAL, OR CONSEQUENTIAL DAMAGES WHICH MAY RESULT FROM USE OF THESE MATERIALS.

MACOM products are not intended for use in medical, lifesaving or life sustaining applications. MACOM customers using or selling MACOM products for use in such applications do so at their own risk and agree to fully indemnify MACOM for any damages resulting from such improper use or sale.