

## Features

- Low Cost
- Small Size and Low Profile
- Excellent Repeatability (Lot-to-Lot Variation)
- Typical Isolation: 23 dB
- Typical Amplitude Balance: 0.8 dB
- Typical Insertion Loss: 1.4 dB
- Lead-Free SOIC-16 Package
- 100% Matte Tin Plating over Copper
- Halogen-Free “Green” Mold Compound
- 260°C Reflow Compatible
- RoHS\* Compliant Version of DS54-0006

## Description

M/A-COM’s MAPDCC0014 is an IC-based monolithic power splitter/combiner in a low cost SOIC-16 plastic package. This device is ideally suited for applications where PCB real estate is at a premium and standard packaging for automated assembly and low cost are critical. Typical applications include infrastructure, portables, and peripheral devices (PCMCIA cards) for wireless standards such as PCS, PCN, DECT, PHS, and DCS-1800. Available in Tape and Reel.

The MAPDCC0014 is fabricated using a passive-integrated circuit process. The process features full-chip passivation for increased performance and reliability.

## Ordering Information

Part Number	Package
MAPDCC0014	Bulk Packaging
MAPDCC0014-TR	1000 piece reel
MAPDCC0014-TB	Sample Test Board

Note: Reference Application Note M513 for reel size information.

## Functional Block Diagram<sup>1</sup>

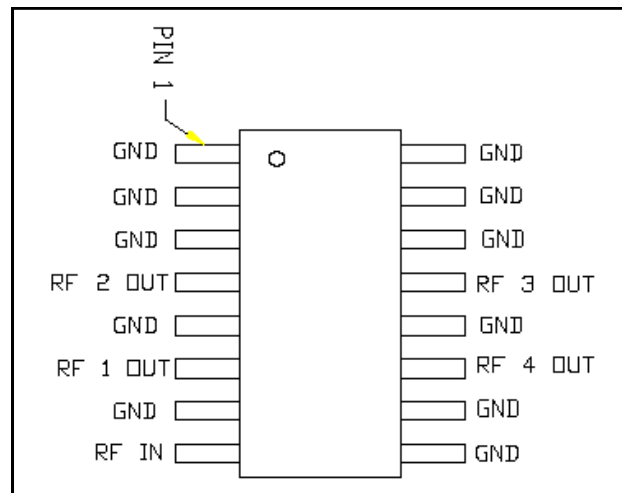

1. All unused pins must be RF and DC grounded.

## Pin Configuration

Pin No.	Function	Pin No.	Function
1	GND	9	GND
2	GND	10	GND
3	GND	11	RF 4 OUT
4	RF 2 OUT	12	GND
5	GND	13	RF 3 OUT
6	RF 1 OUT	14	GND
7	GND	15	GND
8	RF IN	16	GND

<sup>1</sup> \* Restrictions on Hazardous Substances, European Union Directive 2002/95/EC.

**Electrical Specifications:  $T_A = 25^\circ\text{C}$ ,  $Z_0 = 50\Omega$**

Parameter	Units	Min	Typ	Max
Insertion Loss above 6.0 dB	dB	—	1.4	1.7
Isolation 1700 - 2000	dB	18	23	—
VSWR Output	—	—	1.2:1	1.7:1
Input 1700 – 1880	—	—	1.6:1	2.0:1
Input 1880 – 2000	—	—	1.4:1	1.7:1
Amplitude Balance	dB	—	0.8	1.3
Phase Balance	Deg	—	5	10

**Absolute Maximum Ratings <sup>2,3</sup>**

Parameter	Absolute Maximum
Input Power <sup>4</sup>	1 W CW
Operating Temperature	-40°C to +85°C
Storage Temperature	-65°C to +150°C

- Exceeding any one or combination of these limits may cause permanent damage to this device.
- M/A-COM does not recommend sustained operation near these survivability limits.
- With internal load dissipation of 0.125 W Maximum.

**Handling Procedures**

Please observe the following precautions to avoid damage:

**Static Sensitivity**

GMIC Circuits are sensitive to electrostatic discharge (ESD) and can be damaged by static electricity. Proper ESD control techniques should be used when handling these devices.

**Typical Performance Curves @25°C**

**Insertion Loss vs. Frequency**

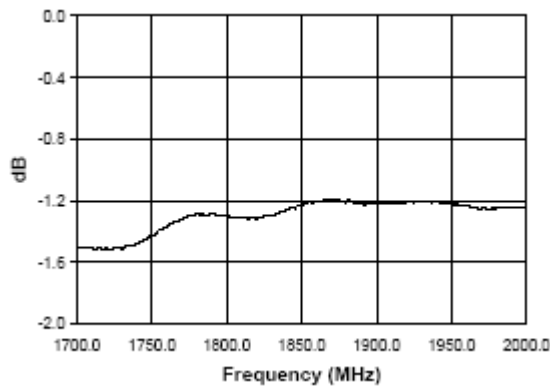

**Amplitude Balance vs. Frequency**

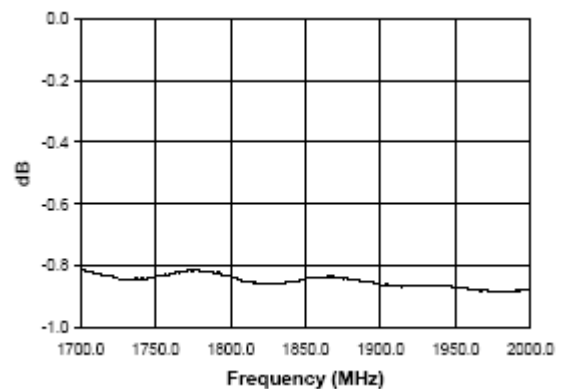

### Typical Performance Curves @25°C

*Isolation vs. Frequency*

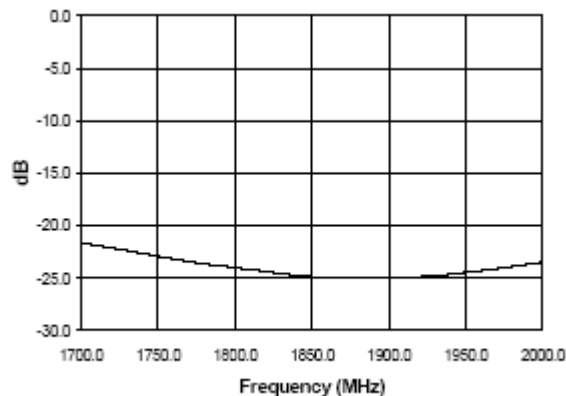

*Phase Balance vs. Frequency*

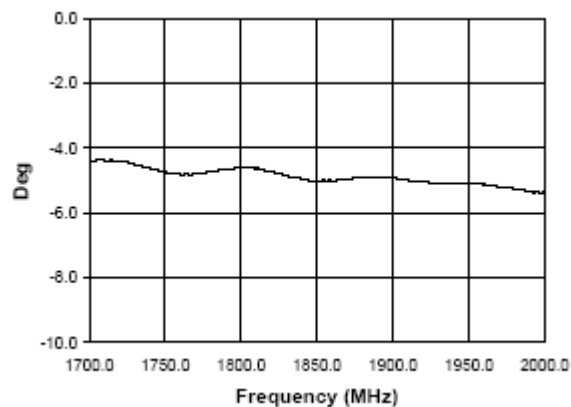

*I/P VSWR vs. Frequency*

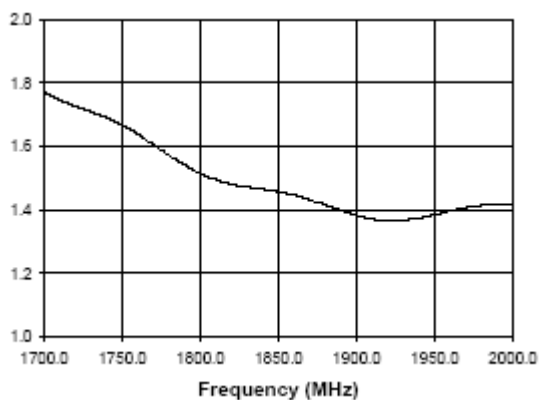

*O/P VSWR vs. Frequency*

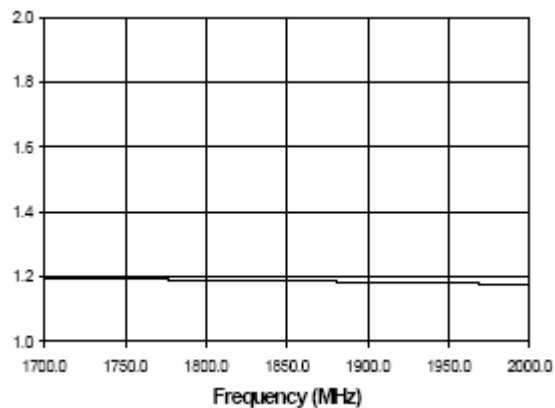

### Lead-Free, SOIC-16<sup>†</sup>

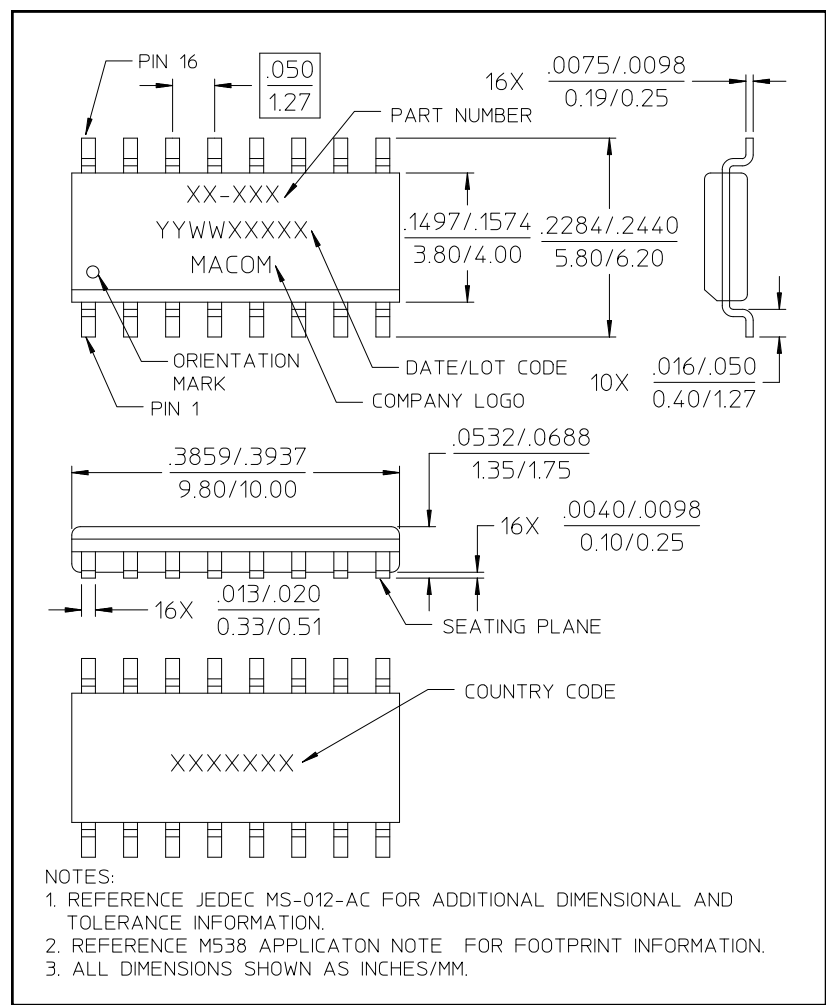

<sup>†</sup> Reference Application Note M538 for lead-free solder reflow recommendations.

M/A-COM Technology Solutions Inc. All rights reserved.

Information in this document is provided in connection with M/A-COM Technology Solutions Inc ("MACOM") products. These materials are provided by MACOM as a service to its customers and may be used for informational purposes only. Except as provided in MACOM's Terms and Conditions of Sale for such products or in any separate agreement related to this document, MACOM assumes no liability whatsoever. MACOM assumes no responsibility for errors or omissions in these materials. MACOM may make changes to specifications and product descriptions at any time, without notice. MACOM makes no commitment to update the information and shall have no responsibility whatsoever for conflicts or incompatibilities arising from future changes to its specifications and product descriptions. No license, express or implied, by estoppel or otherwise, to any intellectual property rights is granted by this document.

THESE MATERIALS ARE PROVIDED "AS IS" WITHOUT WARRANTY OF ANY KIND, EITHER EXPRESS OR IMPLIED, RELATING TO SALE AND/OR USE OF MACOM PRODUCTS INCLUDING LIABILITY OR WARRANTIES RELATING TO FITNESS FOR A PARTICULAR PURPOSE, CONSEQUENTIAL OR INCIDENTAL DAMAGES, MERCHANTABILITY, OR INFRINGEMENT OF ANY PATENT, COPYRIGHT OR OTHER INTELLECTUAL PROPERTY RIGHT. MACOM FURTHER DOES NOT WARRANT THE ACCURACY OR COMPLETENESS OF THE INFORMATION, TEXT, GRAPHICS OR OTHER ITEMS CONTAINED WITHIN THESE MATERIALS. MACOM SHALL NOT BE LIABLE FOR ANY SPECIAL, INDIRECT, INCIDENTAL, OR CONSEQUENTIAL DAMAGES, INCLUDING WITHOUT LIMITATION, LOST REVENUES OR LOST PROFITS, WHICH MAY RESULT FROM THE USE OF THESE MATERIALS.

MACOM products are not intended for use in medical, lifesaving or life sustaining applications. MACOM customers using or selling MACOM products for use in such applications do so at their own risk and agree to fully indemnify MACOM for any damages resulting from such improper use or sale.