

Double-Balanced Mixer

5.5 - 19.0 GHz



MAMX-011035

Rev. V4

Features

- Low Conversion Loss: 6 dB
- Wide IF Bandwidth: DC - 6 GHz
- IIP3 21 dBm @ 15 dBm LO Drive
- High Isolation
- Lead-Free 3 mm 12-lead QFN package
- Lead-free and RoHS* Compliant

Applications

- Test & Measurements
- Microwave Radio
- Radar

Description

MAMX-011035 is a GaAs double-balanced passive diode mixer housed in a lead-free 3 mm, 12-lead QFN package. The mixer offers low conversion loss, high linearity and a wide IF bandwidth. The double-balanced circuit configuration provides excellent port isolation while internal 50 Ω matching simplifies its application.

Ordering Information¹

Part Number	Package
MAMX-011035	Bulk
MAMX-011035-TR0100	100 Piece Reel
MAMX-011035-TR0500	500 Piece Reel
MAMX-011035-SB1	Sample Board

1. Reference Application Note M513 for reel size information.

Functional Schematic

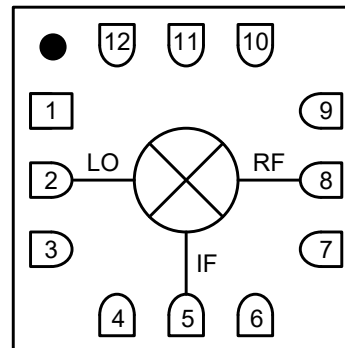

Pin Configuration^{2,3}

Pin #	Function
1,3,4,6,7,9	GND
2	LO
5	IF
8	RF
10 - 12	NC ²
13	GND ³

2. MACOM recommends connecting unused package pins to ground.
3. The exposed pad centered on the package bottom must be connected to RF, DC and thermal ground.

* Restrictions on Hazardous Substances, compliant to current RoHS EU directive.

Double-Balanced Mixer

5.5 - 19.0 GHz



MAMX-011035

Rev. V4

Electrical Specifications⁴: $F_{IF} = 100 \text{ MHz}$, $P_{LO} = 15 \text{ dBm}$, $T_A = +25^\circ\text{C}$, $Z_0 = 50 \Omega$

Parameter	Test Conditions	Units	Min.	Typ.	Max.
LO and RF Frequency	—	GHz	5.5	—	19
IF Frequency	—	GHz	0	—	6
LO Power	—	dBm	—	15	—
Conversion Loss	5.5 - 19 GHz	dB	—	6	8
Input P1dB	5.5 - 10 GHz 10 - 19 GHz	dBm	—	8 11	—
Input IP3	$P_{RF} = -10 \text{ dBm/tone}$, $\Delta f = 1 \text{ MHz}$ 5.5 - 10 GHz 10 - 19 GHz	dBm	—	18 20	—
Input IP2	$P_{RF} = -10 \text{ dBm/tone}$, $\Delta f = 1 \text{ MHz}$ 5.5 - 10 GHz 10 - 19 GHz	dBm	—	45 45	—
LO-to-RF Isolation	5.5 - 10 GHz 10 - 19 GHz	dB	—	38 34	—
LO-to-IF Isolation	5.5 - 10 GHz 10 - 19 GHz	dB	28 32	40 45	—
RF-to-IF Isolation	5.5 - 10 GHz 10 - 19 GHz	dB	10 21	15 30	—

4. All specifications refer to down-conversion operation, unless otherwise noted.

Absolute Maximum Ratings^{5,6}

Parameter	Absolute Maximum
LO Power	23 dBm
RF or IF Power	20 dBm
Junction Temperature ⁷	+150°C
Operating Temperature	-55°C to +85°C
Storage Temperature	-65°C to +150°C

- Exceeding any one or combination of these limits may cause permanent damage to this device.
- MACOM does not recommend sustained operation near these survivability limits.
- Operating at nominal conditions with $T_J \leq +150^\circ\text{C}$ will ensure MTTF > 1×10^6 hours. Thermal resistance, θ_{JC} is 85°C/W.

Handling Procedures

Please observe the following precautions to avoid damage:

Static Sensitivity

These electronic devices are sensitive to electrostatic discharge (ESD) and can be damaged by static electricity. Proper ESD control techniques should be used when handling these devices with the following rating:

HBM Class 1B
CDM Class C5

Assembly Information

- Do not subject the device to excessive force, especially at elevated temperatures > 60°C.
- No-clean flux is required for assembly. Post SMT washing is not recommended.
- Additional handling information is contained on page 6.

Double-Balanced Mixer

5.5 - 19.0 GHz



MAMX-011035

Rev. V4

Typical Performance Curves

Conversion Loss USB (Down Conversion)
@ +25°C, $I_F = 100$ MHz

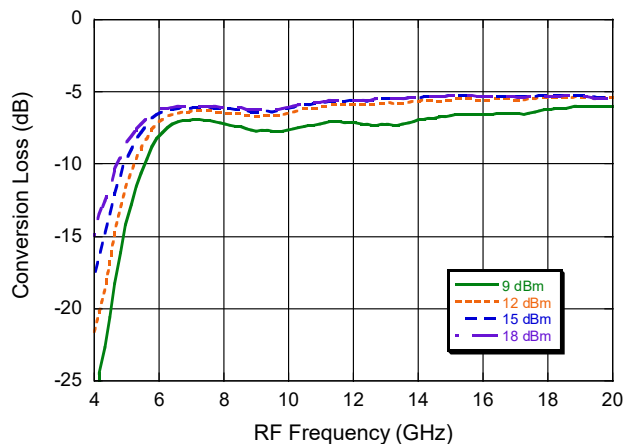

Conversion Loss USB (Up Conversion)
@ +25°C, $I_F = 100$ MHz

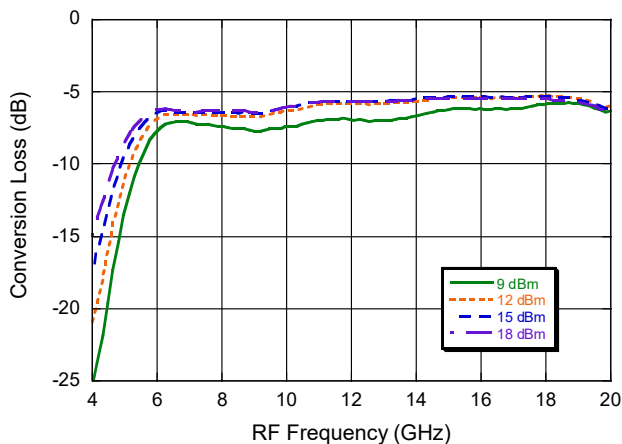

Conversion Loss Over Temperature, $I_F = 100$ MHz

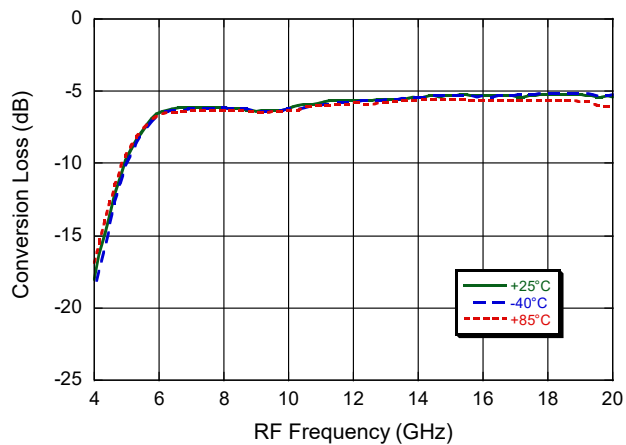

IF Bandwidth
@ +25°C, $F_{LO} = 10$ GHz, $P_{LO} = 15$ dBm

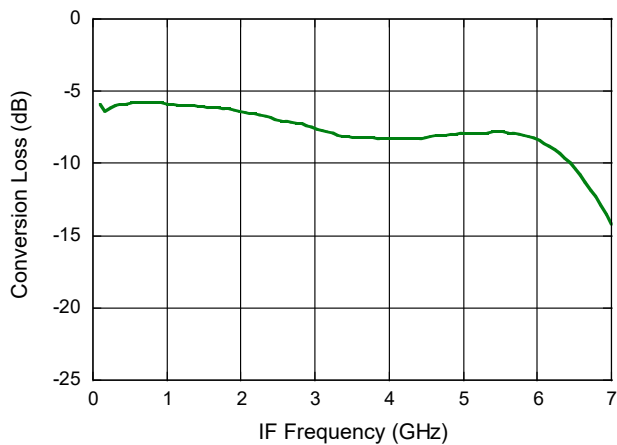

Typical Performance Curves

IIP3 @ LO Power, $I_F = 100$ MHz

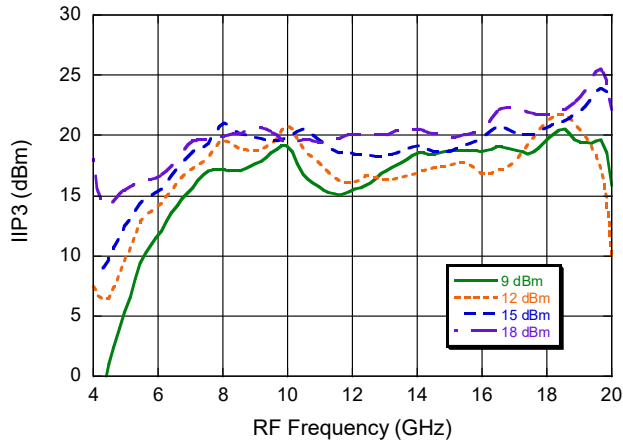

IIP3 over temperature @ $P_{LO} = 15$ dBm, $I_F = 100$ MHz

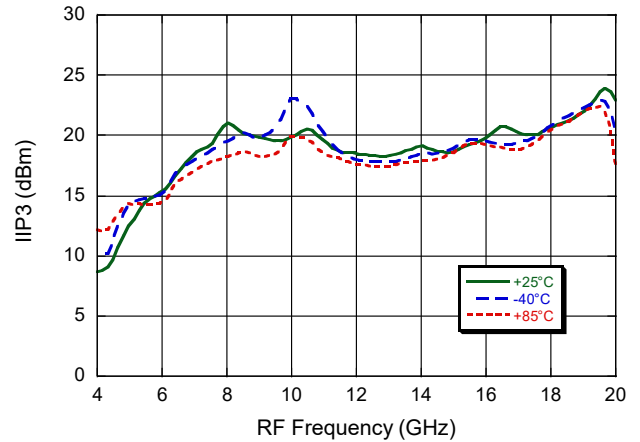

IIP2 @ LO Power, $I_F = 100$ MHz

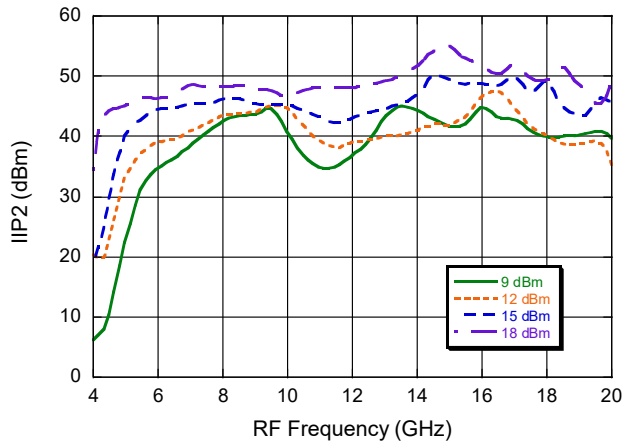

IIP2 over temperature @ $P_{LO} = 15$ dBm, $I_F = 100$ MHz

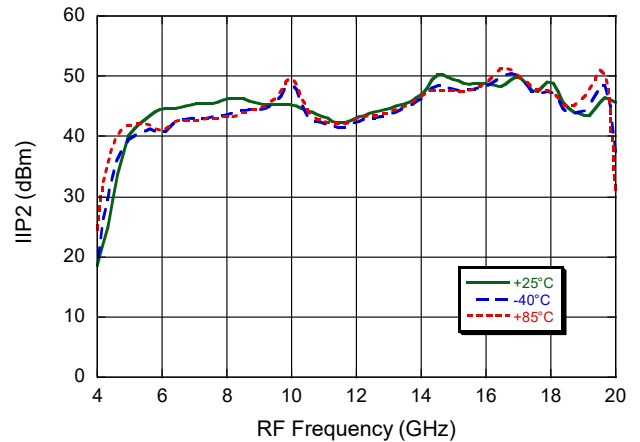

P1dB @ LO Power, $I_F = 100$ MHz

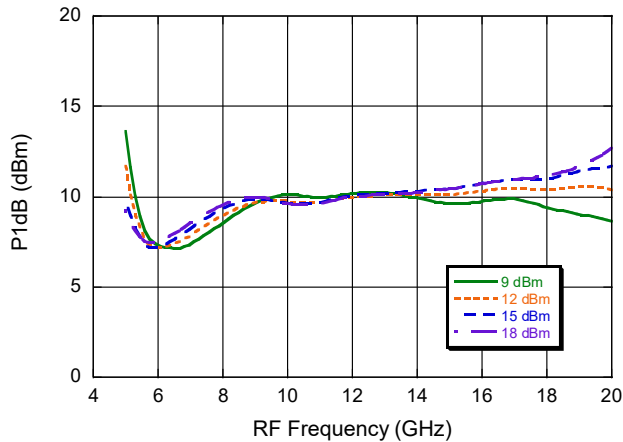

Double-Balanced Mixer

5.5 - 19.0 GHz



MAMX-011035

Rev. V4

Typical Performance Curves

Isolation (Down Conversion)

@ $I_F = 100 \text{ MHz}$, $P_{LO} = 15 \text{ dBm}$; $P_{RF} = -10 \text{ dBm}$

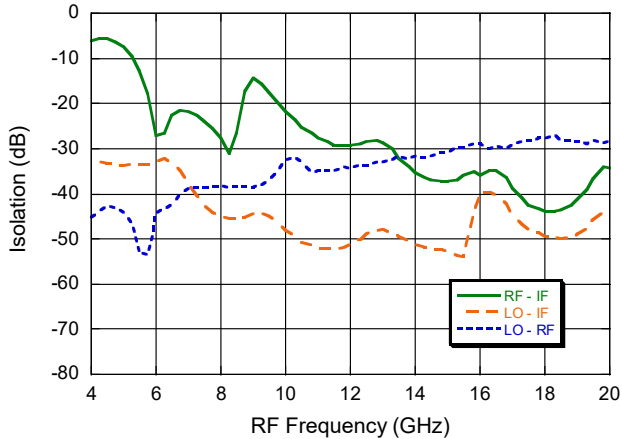

Isolation (Up Conversion)

@ $I_F = 100 \text{ MHz}$, $P_{LO} = 15 \text{ dBm}$; $P_{RF} = -10 \text{ dBm}$

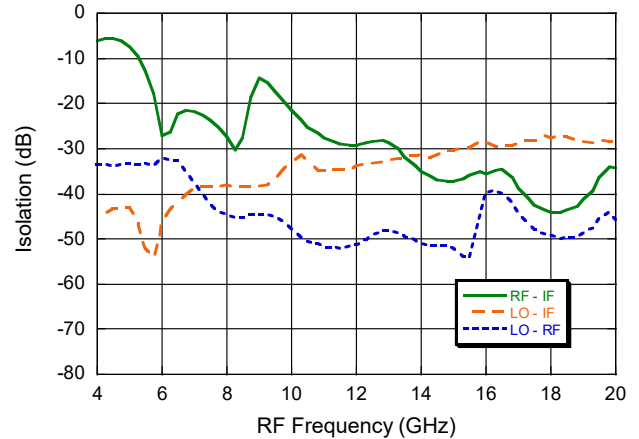

RF Return Loss

@ $+25^\circ\text{C}$, $F_{LO} = 10 \text{ GHz}$, $P_{LO} = 15 \text{ dBm}$

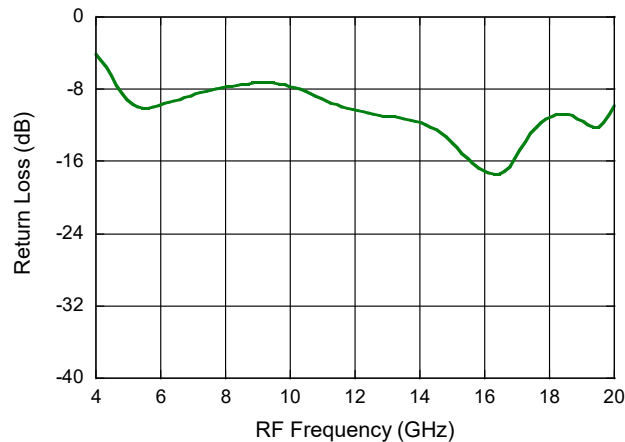

IF Return Loss

@ $+25^\circ\text{C}$, $F_{LO} = 10 \text{ GHz}$, $P_{LO} = 15 \text{ dBm}$

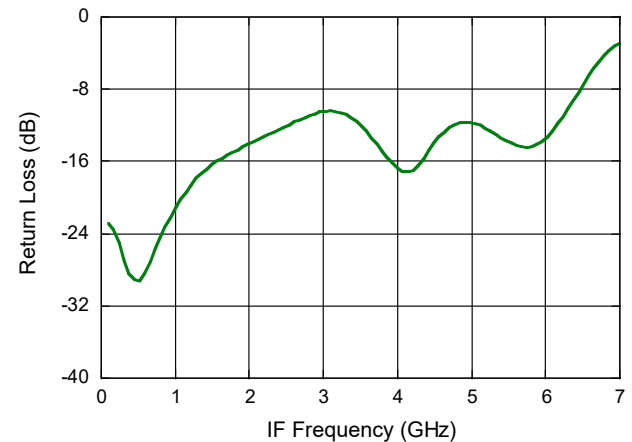

MxN Spurious Rejection at IF Port (dBc IF)

RF = 10.1 GHz @ -10 dBm

LO = 10.0 GHz @ +15 dBm

MxRF	NxLO				
	0	1	2	3	4
0	x	16	42	18	22
1	20	0	44	61	49
2	91	84	75	78	91
3	80	97	83	74	83
4	x	x	x	x	92

5

MACOM Technology Solutions Inc. (MACOM) and its affiliates reserve the right to make changes to the product(s) or information contained herein without notice. Visit www.macom.com for additional data sheets and product information.

For further information and support please visit:
<https://www.macom.com/support>

DC-0011165

PCB Layout

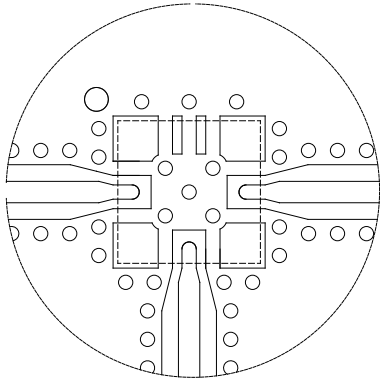

DXF available on request based on 10 mil RO4350 substrate.

Application Schematic

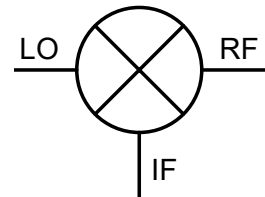

No external parts required for operation of MAMX-011035.

Guidelines for Engineering Lab Assembly and Rework replacement

A. Reflow Oven with Brand New PCB

1. Apply paste evenly using screen to new PCB, or use manual dispenser (difficult to apply evenly).
2. Place component on top of solder paste, ensuring correct positioning relative to pin 1.
3. Set reflow oven to required profile for a leadfree paste, see profile in Application Note S2083.
4. Ensure correct speed of the conveyor belt (needs to be checked for a particular oven type).
5. Place remaining parts onto board.
6. Measure board.

B. Replacing Existing Part with Hot Plate - Heat Applied Underneath the PCB

(Recommending using a hot plate with localised heat to the mixer area).

1. Firstly prepare the new MAMX-011035 part to be installed.
2. Flip MAMX-011035 and apply a thin layer of solder on each pad. Ensure an appropriate amount of solder is applied to middle ground paddle also.
3. Next step is to remove existing mixer part already attached to the board.
4. Set the hot plate at 285°C temperature.
5. Place block underneath mixer from base plate to localise heat to mixer area only.
6. Remove existing mixer part when solder reflows.
7. Apply flux to PCB pins and centre ground area.
8. Ensure sufficient solder is visible on pads.
9. Align and position MAMX-011035 to correct position on PCB, relative to pin 1.
10. Observe solder reflow.
11. Then remove PCB from hot plate.
12. Allow to cool and measure.

- **Do not apply heat from above the MAMX-011035 with heat gun.**
- **Post SMT washing is not recommended.**

Double-Balanced Mixer

5.5 - 19.0 GHz



MAMX-011035

Rev. V4

Lead-Free 3 mm 12-Lead AQFN[†]

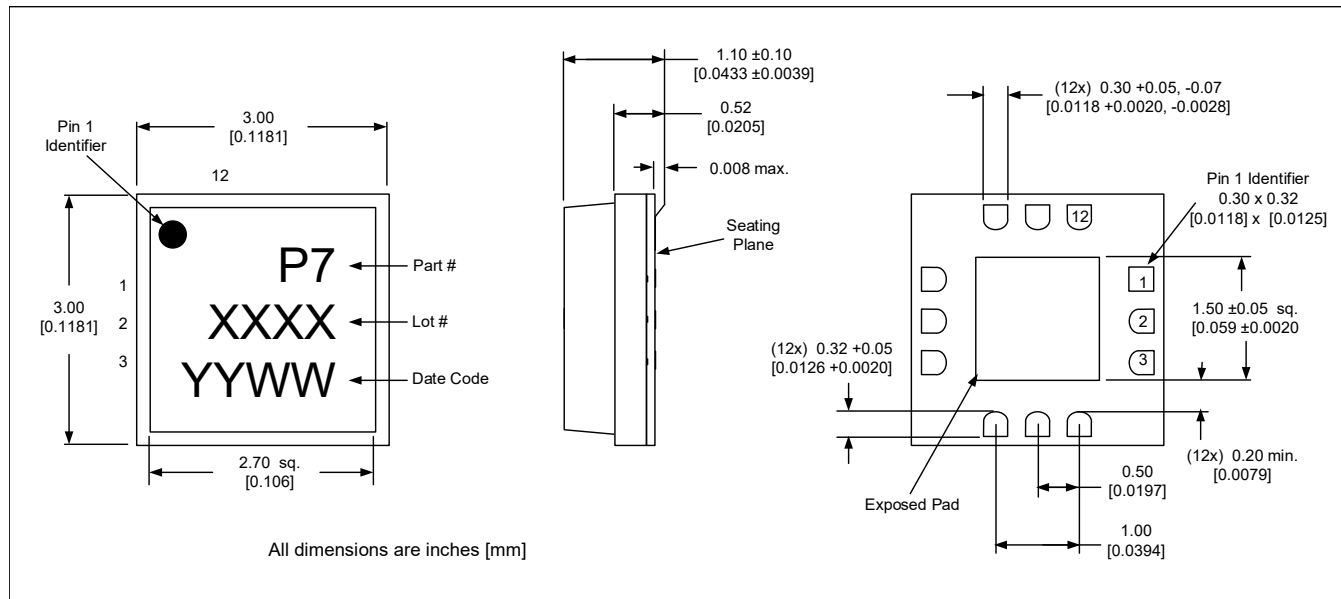

[†] Reference Application Note S2083 for lead-free solder reflow recommendations.
 Meets JEDEC moisture sensitivity level 3 requirements.
 Plating is NiPdAu

Double-Balanced Mixer

5.5 - 19.0 GHz



MAMX-011035

Rev. V4

MACOM Technology Solutions Inc. ("MACOM"). All rights reserved.

These materials are provided in connection with MACOM's products as a service to its customers and may be used for informational purposes only. Except as provided in its Terms and Conditions of Sale or any separate agreement, MACOM assumes no liability or responsibility whatsoever, including for (i) errors or omissions in these materials; (ii) failure to update these materials; or (iii) conflicts or incompatibilities arising from future changes to specifications and product descriptions, which MACOM may make at any time, without notice. These materials grant no license, express or implied, to any intellectual property rights.

THESE MATERIALS ARE PROVIDED "AS IS" WITH NO WARRANTY OR LIABILITY, EXPRESS OR IMPLIED, RELATING TO SALE AND/OR USE OF MACOM PRODUCTS INCLUDING FITNESS FOR A PARTICULAR PURPOSE, MERCHANTABILITY, INFRINGEMENT OF INTELLECTUAL PROPERTY RIGHT, ACCURACY OR COMPLETENESS, OR SPECIAL, INDIRECT, INCIDENTAL, OR CONSEQUENTIAL DAMAGES WHICH MAY RESULT FROM USE OF THESE MATERIALS.

MACOM products are not intended for use in medical, lifesaving or life sustaining applications. MACOM customers using or selling MACOM products for use in such applications do so at their own risk and agree to fully indemnify MACOM for any damages resulting from such improper use or sale.