

Integrated Switch and LNA Module

1 - 6 GHz



MAMF-011126

Rev. V2

Features

- High Power SPDT Switch and 2-Stage LNA
- Broadband: 1 - 6 GHz
- No External Matching Components Required
- RX Mode Gain:
 - 35.2 dB @ 2.50 GHz
 - 34.0 dB @ 3.75 GHz
 - 33.5 dB @ 4.50 GHz
- RX Mode Noise Figure:
 - 1.2 dB @ 2.50 GHz
 - 1.3 dB @ 3.75 GHz
 - 1.4 dB @ 4.50 GHz
- TX Mode at 2.3 - 5.0 GHz:
 - Insertion Loss: 0.35 dB
 - P0.1dB: 40.5 dBm
- Single 5 V Supply
- Low DC Current: 78 mA in RX Mode
- Integrated Control Circuitry with 1.8 V Logic
- Lead-Free 6 mm 20 Lead QFN Package
- RoHS* Compliant

Applications

- 5G Massive MIMO
- Wireless Infrastructure
- TDD-based communication systems

Description

The MAMF-011126 is a compact surface mount, highly integrated high power SPDT switch and 2-stage low noise amplifier (LNA) module. It includes an antenna switch and a LNA in a compact 6 mm QFN package. All the bias circuitry and matching components are internal to the module.

This module operates from 1 - 6 GHz and features high power handling, low noise figure, high linearity and low power consumption. The module requires a single 5 V supply and the T/R switch is 1.8 V CMOS compatible.

Ordering Information^{1,2}

Part Number	Package
MAMF-011126-TR1000	1000 piece reel
MAMF-011126-001SMB	Sample Board

1. Reference Application Note M513 for reel size information.
2. All sample boards include 5 loose parts.

Functional Schematic

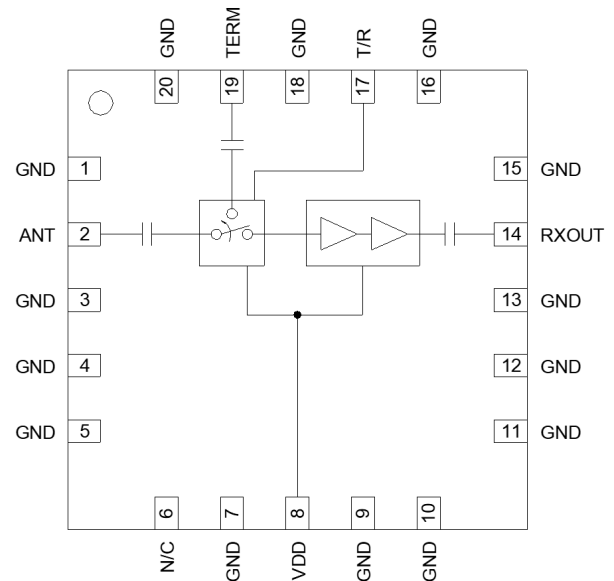

Pin Configuration³

Pin #	Pin Name	Description
1, 3-5, 7, 9-13, 15, 16, 18, 20	GND	Ground
2	ANT	RF Antenna Port
6	N/C	Internally No Connect
8	V _{DD}	Supply Voltage
14	RXOUT	RX Output Port
17	T/R	Logic Signaling Pin
19	TERM	Termination Port
21	Paddle ⁴	Ground

3. MACOM recommends connecting GND and No Connection (N/C) pins to ground.
4. The exposed paddle centered on the package bottom must be connected to RF, DC & thermal ground.

¹ * Restrictions on Hazardous Substances, compliant to current RoHS EU directive.

AC Electrical Specifications (RX Mode)

Freq. = 4.7 GHz, P_{IN} = -30 dBm, T_C = +25°C, V_{DD} = 5 V, Z₀ = 50 Ω

Parameter	Test Conditions	Units	Min.	Typ.	Max.
Gain	ANT to RXOUT	dB	31.5	33.5	35.5
Input IP3	P _{IN} /Tone = -33 dBm, Tone Delta = 2 MHz, ANT to RXOUT	dBm	—	-5	—
Input P1dB	ANT to RXOUT	dBm	—	-17	—
Noise Figure	ANT to RXOUT	dB	—	1.4	—
ANT Port Return Loss	ANT Port	dB	—	21	—
RXOUT Port Return Loss	RXOUT Port	dB	—	21	—
Reverse Isolation	RXOUT to ANT	dB	—	48	—
ANT - TERM Isolation	ANT to TERM	dB	—	27	—

AC Electrical Specifications (TX Mode)

Freq. = 4.7 GHz, P_{IN} = -10 dBm, T_C = +25°C, V_{DD} = 5 V, Z₀ = 50 Ω

Parameter	Test Conditions	Units	Min.	Typ.	Max.
Insertion Loss	ANT to TERM	dB	—	0.35	1
P0.1dB Compression Point	ANT to TERM	dBm	—	40	—
ANT Port Return Loss	ANT Port	dB	—	22	—
TERM Port Return Loss	TERM Port	dB	—	23	—
ANT - RXOUT Isolation	ANT to RXOUT	dB	—	58	—
ANT Port Input Power	ANT Port, 4.7 GHz, CW, T _C = 105°C ANT Port, 4.7 GHz, LTE (10dB PAR), T _C = 105°C	dBm	—	39 36	—

Transient Electrical Specifications:

Freq. = 4.7 GHz, $P_{IN} = -30$ dBm, $T_C = 25^\circ\text{C}$, $V_{DD} = 5$ V, $Z_0 = 50 \Omega$

Parameter	Test Conditions	Units	Min.	Typ.	Max.
T/R Gain Settling Time	ANT to RXOUT gain settling time within 0.3 dB of final value after T/R command	μs	—	0.3	—
T/R Insertion Loss Settling Time	ANT to TERM path insertion loss settling time within 0.3 dB of final value after T/R command	μs	—	0.3	—
Power on Gain Settling Time	ANT to RXOUT gain settling time within 0.5 dB of final value after DC power on	ms	—	1	—
Power on Insertion Loss Settling Time	ANT to TERM settling time within 0.5 dB of final value after DC power on	ms	—	1	—

DC Electrical Specifications: $T_C = 25^\circ\text{C}$, $V_{DD} = 5$ V, $Z_0 = 50 \Omega$

Parameter	Test Conditions	Units	Min.	Typ.	Max.
Supply Voltage	V_{DD} Pin, RX/TX Mode	V	—	5	—
Amplifier Bias Current	RX Mode TX Mode	mA	—	78 1.4	—
T/R Control Voltage	RX Mode, Logic High TX Mode, Logic Low	V	—	1.8 0	—
T/R Logic Input Current	RX Mode, Logic High TX Mode, Logic Low	μA	—	40 +/-0.03	—

Control Truth Table

T/R Control	
RX Mode	Logic High
TX Mode	Logic Low or Open

Absolute Maximum Ratings^{5,6}

Parameter	Absolute Maximum
Antenna Input Power ⁷ Freq. = 4.7 GHz: RX Mode TX Mode	17 dBm LTE (10 dB PAR), 26 dBm CW 39 dBm LTE (10 dB PAR), 42 dBm CW
DC Voltages: V _{DD} , ANT & TERM T/R & RXOUT	-0.5 to +5.5 V -0.5 to +2.75 V
Junction Temperature: RX Mode ^{8,10} TX Mode ^{8,10} TX Mode ⁷	+150°C +125°C +140°C
Operating Temperature ⁹	-40°C to +105°C
Storage Temperature	-55°C to +150°C

5. Exceeding any one or combination of these limits may cause permanent damage to this device.

6. MACOM does not recommend sustained operation near these survivability limits.

7. Single event, up to 10 seconds duration.

8. Operating at nominal conditions with $T_J \leq +150^\circ\text{C}$ (RX Mode) and $T_J \leq +125^\circ\text{C}$ (TX Mode) will ensure MTTF $\gg 1 \times 10^6$ hours.

9. Operating/Case temperature (T_C) is the temperature of the exposed paddle.

10. Junction Temperature (T_J) = $T_C + \Theta_{JC} * P_{DISS}$ where P_{DISS} is the total DC & RF dissipated power.

- RX Mode: Typical thermal resistance (Θ_{JC}) = 33.4°C/W.
- TX Mode: Typical thermal resistance (Θ_{JC}) = 9.8°C/W.

Handling Procedures

Please observe the following precautions to avoid damage:

Static Sensitivity

These electronic devices are sensitive to electrostatic discharge (ESD) and can be damaged by static electricity. Proper ESD control techniques should be used when handling these devices.

Power Supplies

De-coupling capacitors should be placed at the V_{DD} supply pin to minimize noise and fast transients. Supply voltage change or transients should have a slew rate smaller than 1 V / 10 μs. In addition, all control pins should remain at 0 V (+/- 0.3 V) and no RF power should be applied while the supply voltage ramps or while it returns to zero.

Parameter	Rating	Standard
Human Body Model (HBM)	1000 V (Class 1C)	ESDA/JEDEC JS -001
Charged Device Model (CDM)	1000 V (Class C3)	ESDA/JEDEC JS -002

Sample Board Schematic

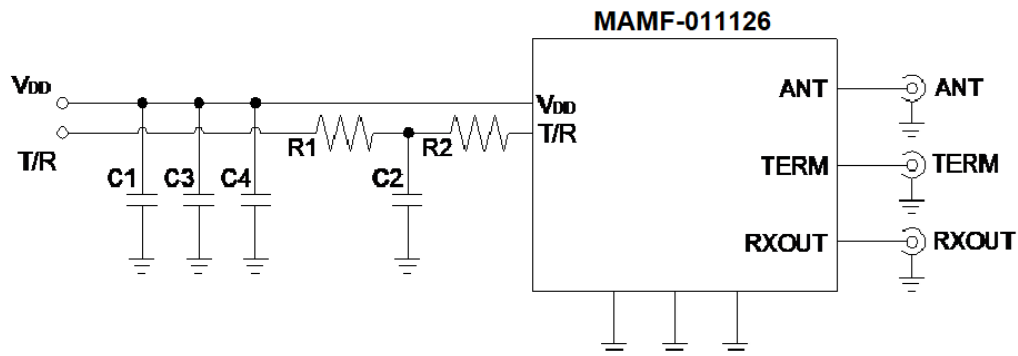

Sample Board PCB Layout

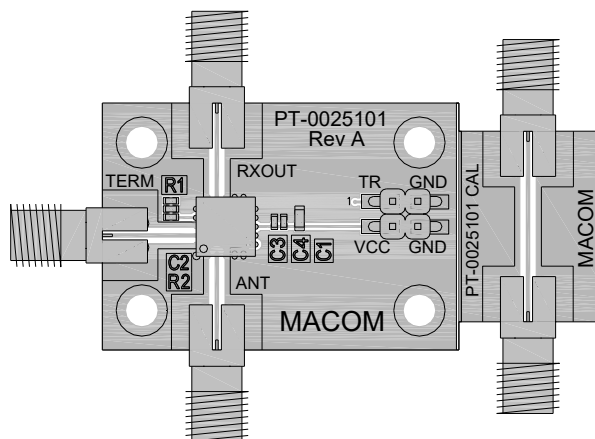

Parts List

Part	Value	Case style
C1	10 μ F	0603
C2	5 pF	0402
C3	10 nF	0402
C4	470 pF	0402
R1	1 k Ω	0402
R2	100 Ω	0402

Recommended Thermal Land Pattern

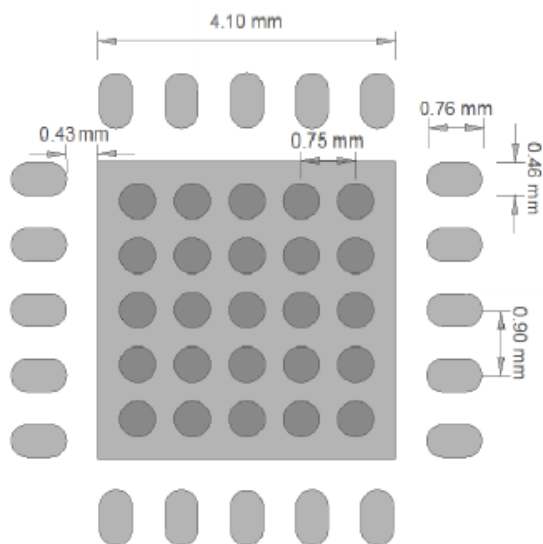

- Material: Megtron 4S R-5735S
- Dielectric thickness: 0.254 mm
- Track/Gap: 0.45/0.6 mm
- Finished copper thickness: 44 μ m +/- 10 μ m
- Finish both sides: 0.075 μ m gold over 4.5 μ m nickel
- Further layout information available on request

- 25 Ground Vias
- 0.5 mm Diameter, 1/2 oz. Copper

Typical Performance Curves:

$P_{IN} = -30 \text{ dBm}$, $V_{DD} = 5 \text{ V}$, $T_C = +25^\circ\text{C}$, $Z_0 = 50 \Omega$ (unless otherwise indicated)

ANT to RXOUT Gain¹¹ - RX Mode

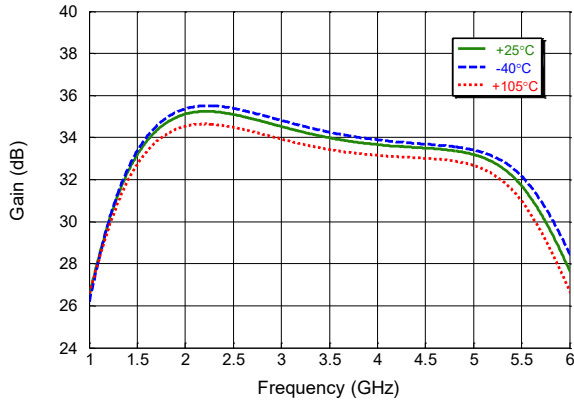

ANT to RXOUT Gain¹¹ - RX Mode

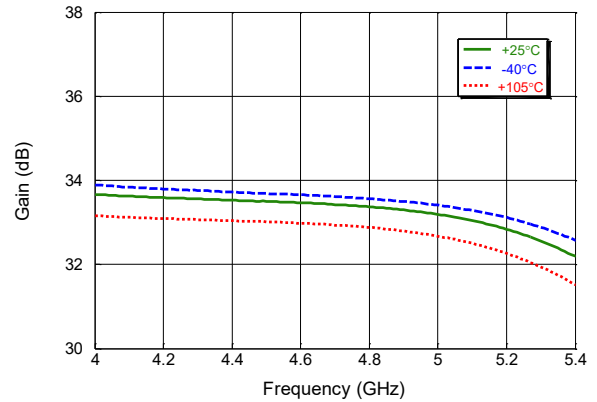

ANT Port Return Loss - RX Mode

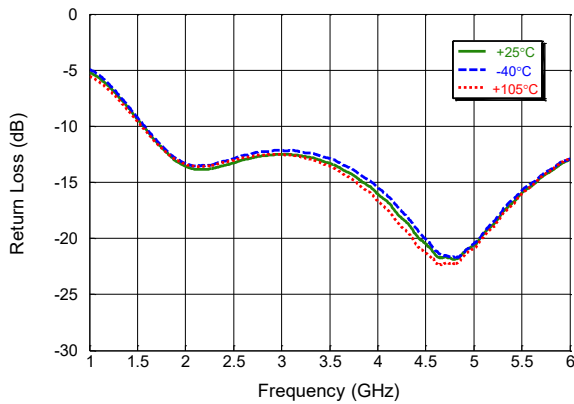

ANT Port Return Loss - RX Mode

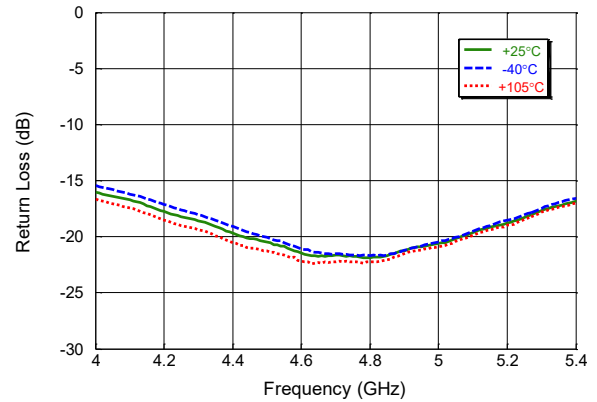

RXOUT Port Return Loss - RX Mode

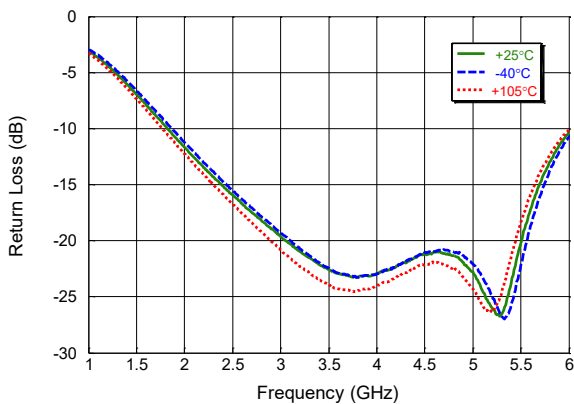

RXOUT Port Return Loss - RX Mode

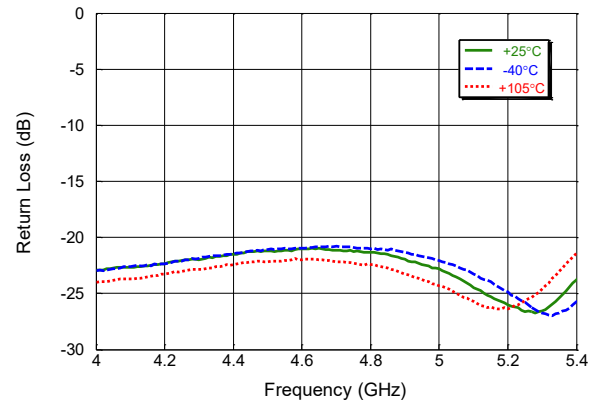

11. For gain, noise figure, insertion loss and isolation plots, RF trace and connector losses are de-embedded.

Typical Performance Curves:

$P_{IN} = -30$ dBm, $V_{DD} = 5$ V, $T_C = +25^\circ\text{C}$, $Z_0 = 50 \Omega$ (unless otherwise indicated)

ANT to RXOUT Noise Figure¹¹ - RX Mode

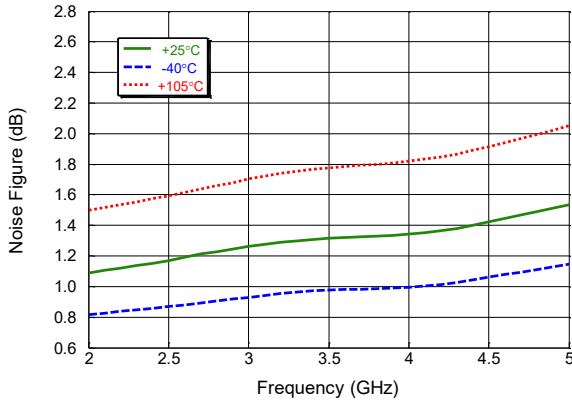

Supply Current - RX Mode

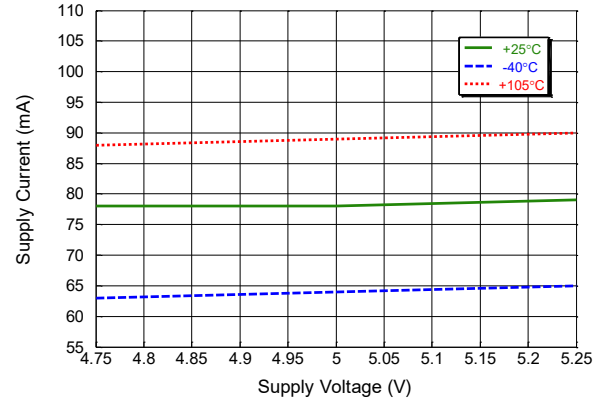

ANT to RXOUT Port Reverse Isolation¹¹ - RX Mode

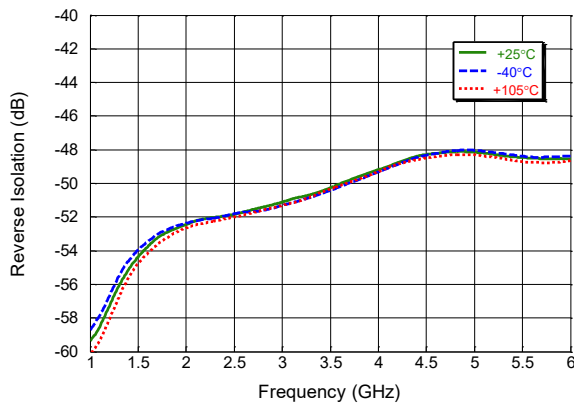

ANT to RXOUT Port Reverse Isolation¹¹ - RX Mode

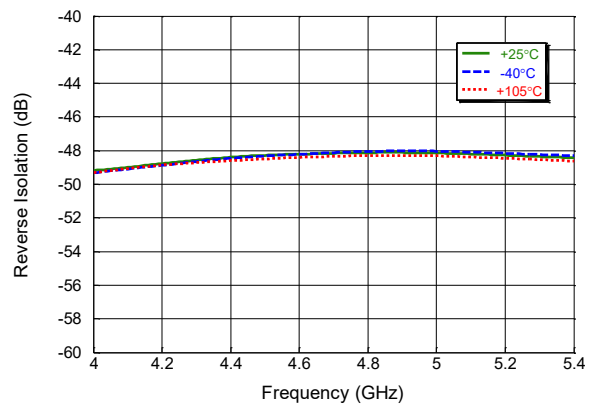

ANT to TERM Port Switch Isolation¹¹ - RX Mode

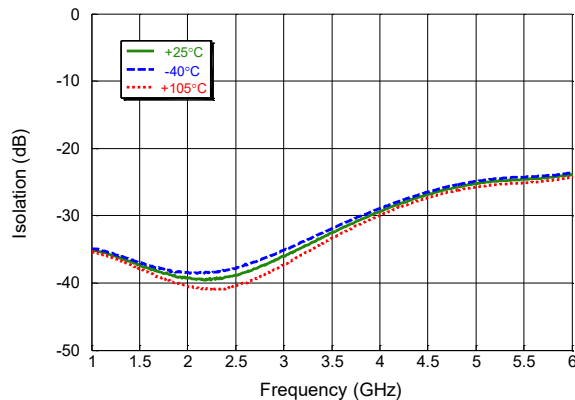

ANT to TERM Port Switch Isolation¹¹ - RX Mode

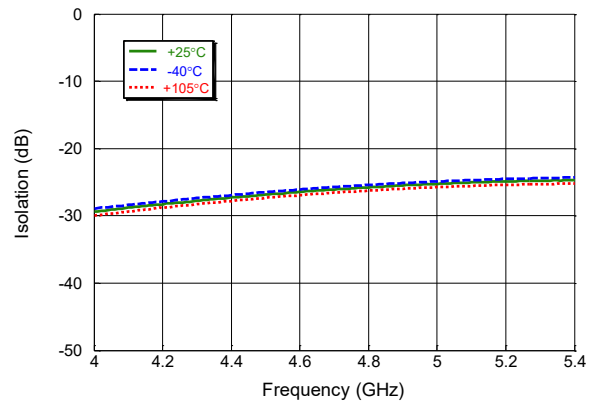

11. For gain, noise figure, insertion loss and isolation plots, RF trace and connector losses are de-embedded.

Typical Performance Curves

$P_{IN} = -30$ dBm, $V_{DD} = 5$ V, $T_C = +25^\circ\text{C}$, $Z_0 = 50 \Omega$ (unless otherwise indicated)

ANT to TERM Switch Insertion Loss¹¹ - TX Mode

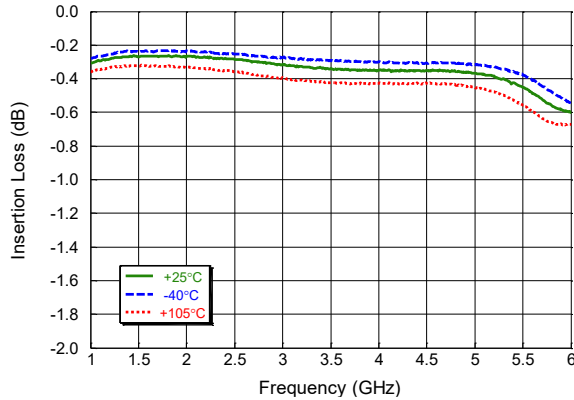

ANT to TERM Switch Insertion Loss¹¹ - TX Mode

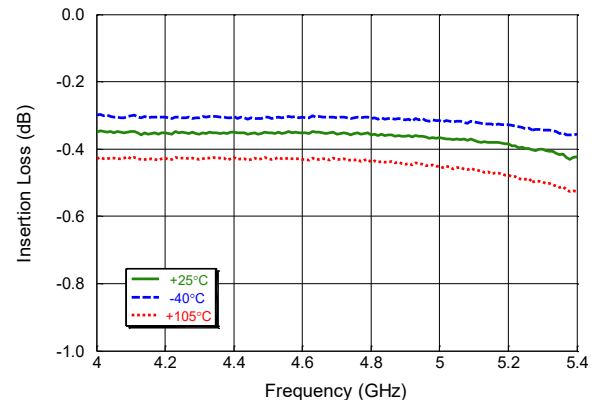

ANT Port Return Loss - TX Mode

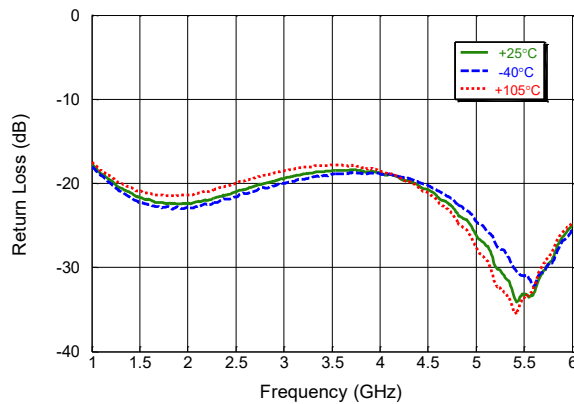

ANT Port Return Loss - TX Mode

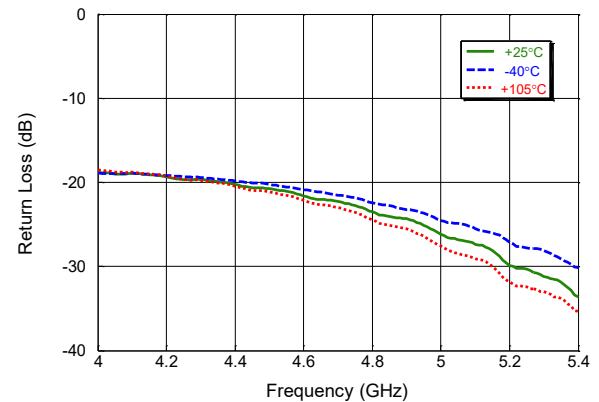

TERM Port Return Loss - TX Mode

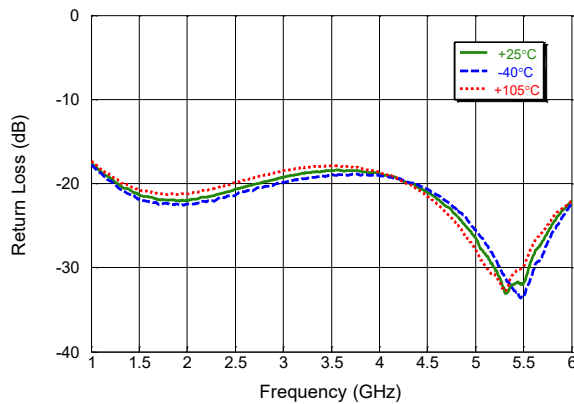

TERM Port Return Loss - TX Mode

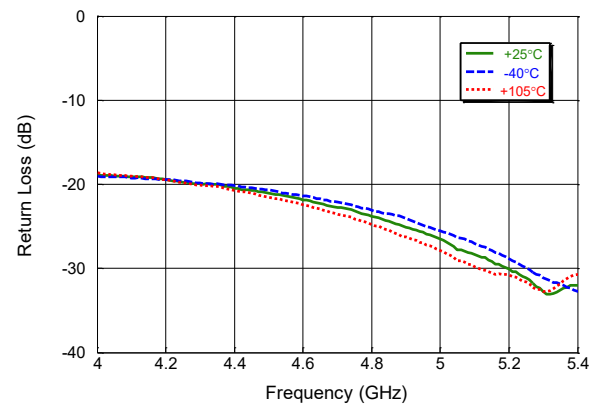

11. For gain, noise figure, insertion loss and isolation plots, RF trace and connector losses are de-embedded.

Typical Performance Curves

$P_{IN} = -30$ dBm, $V_{DD} = 5$ V, $T_C = +25^\circ\text{C}$, $Z_0 = 50 \Omega$ (unless otherwise indicated)

ANT to TERM Port Compression Characteristic¹¹ at 4.7 GHz - TX mode

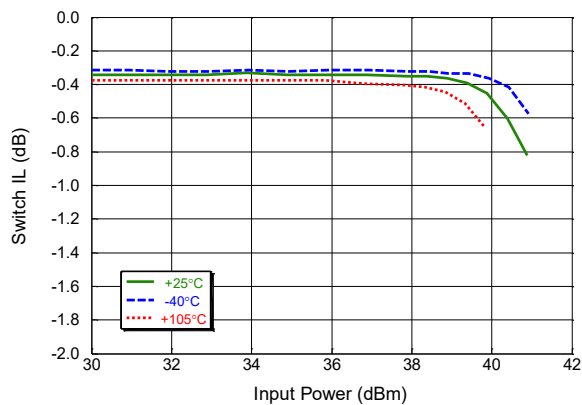

11. For gain, noise figure, insertion loss and isolation plots, RF trace and connector losses are de-embedded.

Lead-Free 6 mm 20-Lead QFN[†]

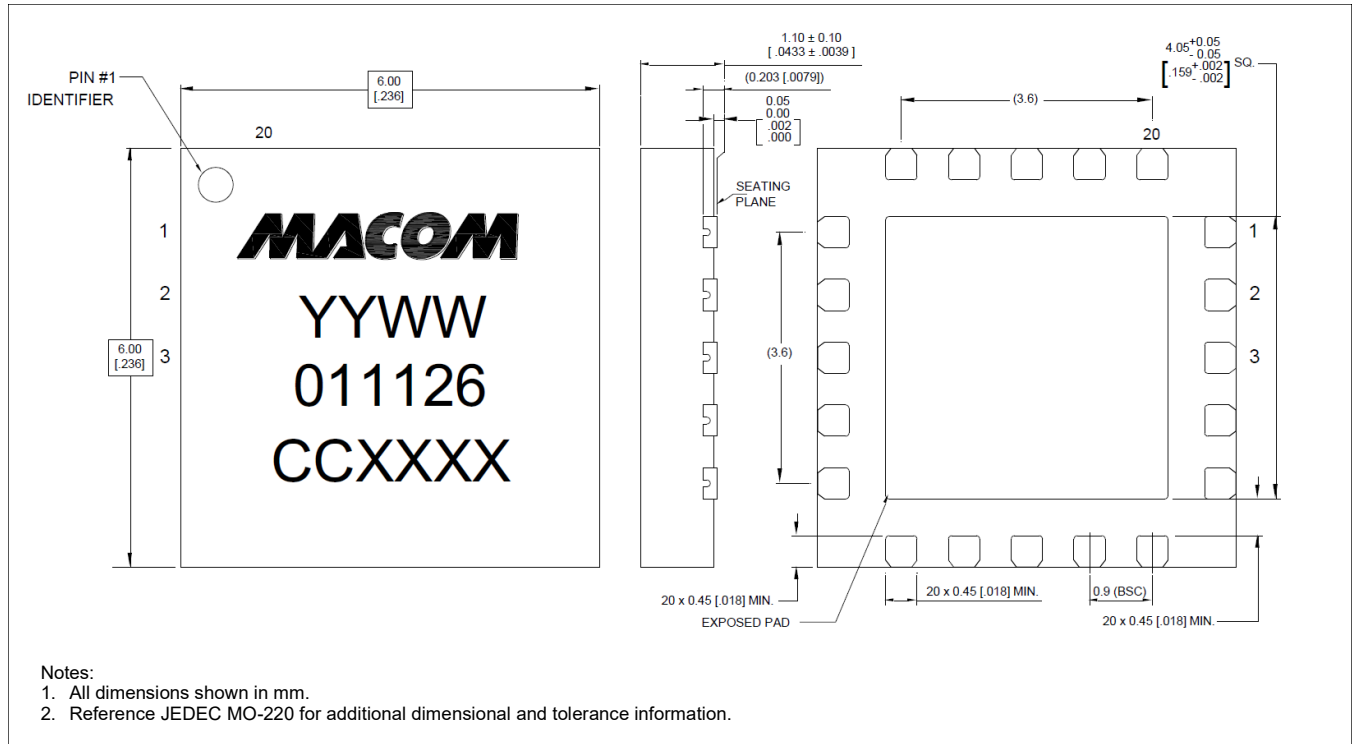

[†] Reference Application Note S2083 for lead-free solder reflow recommendations.
 Meets JEDEC moisture sensitivity level 3 requirements in accordance to JEDEC J-STD-020D.
 Plating is NiPdAuAg over Copper

MACOM Technology Solutions Inc. ("MACOM"). All rights reserved.

These materials are provided in connection with MACOM's products as a service to its customers and may be used for informational purposes only. Except as provided in its Terms and Conditions of Sale or any separate agreement, MACOM assumes no liability or responsibility whatsoever, including for (i) errors or omissions in these materials; (ii) failure to update these materials; or (iii) conflicts or incompatibilities arising from future changes to specifications and product descriptions, which MACOM may make at any time, without notice. These materials grant no license, express or implied, to any intellectual property rights.

THESE MATERIALS ARE PROVIDED "AS IS" WITH NO WARRANTY OR LIABILITY, EXPRESS OR IMPLIED, RELATING TO SALE AND/OR USE OF MACOM PRODUCTS INCLUDING FITNESS FOR A PARTICULAR PURPOSE, MERCHANTABILITY, INFRINGEMENT OF INTELLECTUAL PROPERTY RIGHT, ACCURACY OR COMPLETENESS, OR SPECIAL, INDIRECT, INCIDENTAL, OR CONSEQUENTIAL DAMAGES WHICH MAY RESULT FROM USE OF THESE MATERIALS.

MACOM products are not intended for use in medical, lifesaving or life sustaining applications. MACOM customers using or selling MACOM products for use in such applications do so at their own risk and agree to fully indemnify MACOM for any damages resulting from such improper use or sale.