

GaN Amplifier 48 V, 110 W

2.5 - 2.7 GHz



MAGB-102527-110A0P

Rev. V2

Features

- Optimized for Cellular Base Station Applications
- Designed for Digital Predistortion Error Correction Systems
- High Terminal Impedances for Broadband Performance
- 48 V Operation
- 100 % RF Tested
- RoHS* Compliant



7 x 10 mm DFN

Description

The MAGB-102527-110A0P GaN HEMT D-mode amplifier is designed for base station applications and is optimized for 2.5 - 2.7 GHz modulated signal operation. This device supports pulsed and linear operation with peak output power levels to 110W (50.4 dBm) in a 7 x 10 mm DFN package.

Typical RF Performance

- WCDMA 3GPP TM1 64 DPCH 9.9 dB PAR @ 0.01% CCDF, $V_{DS} = 48$ V, $I_{DQCAR} = 105$ mA, $V_{GSPK} = -4.2$ V, $T_C = 25^\circ\text{C}$, $P_{OUT} = 41.5$ dBm.

Frequency (GHz)	G_P (dB)	η_D (%)	Output PAR (dB)	ACPR (dBc)
2.5	15.9	53	8.6	-29
2.6	16.0	51	8.6	-32
2.7	15.6	50	8.4	-34

Functional Schematic

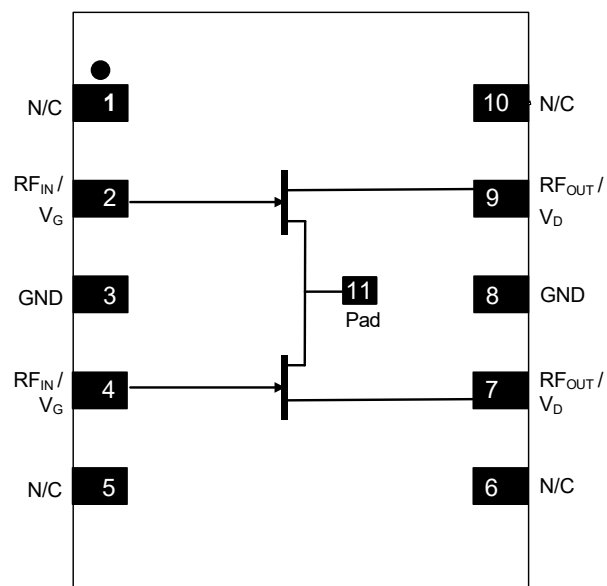

Pin Configuration

Pin #	Pin Name	Function
1,5,6,10	N/C	No Connection
2	RF _{IN} / V _G	RF Input / Gate (Carrier)
9	RF _{OUT} / V _D	RF Output / Drain (Carrier)
4	RF _{IN} / V _G	RF Input / Gate (Peaking)
7	RF _{OUT} / V _D	RF Output / Drain (Peaking)
3,8,11	Pad ¹	Ground / Source

1. The pad on the package bottom must be connected to RF, DC and thermal ground.

Ordering Information

Part Number	Package
MAGB-102527-110A0P	Bulk Quantity
MAGB-102527-110ATP	Tape and Reel
MAGB-1D2527-110A0P	Doherty Sample Board

* Restrictions on Hazardous Substances, compliant to current RoHS EU directive.

GaN Amplifier 48 V, 110 W

2.5 - 2.7 GHz



MAGB-102527-110A0P

Rev. V2

RF Electrical Characteristics: $T_C = 25^\circ\text{C}$, $V_{DS} = 48\text{ V}$, $I_{DQCAR} = 105\text{ mA}$, $V_{GSPK} = -4.2\text{ V}$
Note: Performance in MACOM Doherty Evaluation Test Fixture, $50\ \Omega$ system.

Parameter	Test Conditions	Symbol	Min.	Typ.	Max.	Units
Small Signal Gain	Pulsed ² , 2.6 GHz	G_{SS}	-	17.4	-	dB
Saturated Output Power	Pulsed ² , 2.6 GHz	P_{SAT}	-	49.5	-	dBm
Drain Efficiency at Saturation	Pulsed ² , 2.6 GHz	η_{SAT}	-	61	-	%
AM/PM	Pulsed ² , 2.6 GHz	Φ	-	6	-	°
Modulated Peak Power	WCDMA ³ , 2.6 GHz	$P_{2.5dB}^4$	-	50.9	-	dBm
Gain Flatness in 60MHz	WCDMA ³ , $P_{OUT} = 41.5\text{ dBm}$	G_F	-	0.2	-	dB
Gain Variation (-25°C to +105°C)	WCDMA ³ , 2.6 GHz, $P_{OUT} = 41.5\text{ dBm}$	ΔG	-	0.02	-	dB/°C
Power Variation (-25°C to +105°C)	Pulsed ² , 2.6 GHz	$\Delta P_{2.5dB}$	-	0.01	-	dB/°C
Power Gain	WCDMA ³ , 2.6 GHz, $P_{OUT} = 41.5\text{ dBm}$	G_P	-	16.0	-	dB
Drain Efficiency	WCDMA ³ , 2.6 GHz, $P_{OUT} = 41.5\text{ dBm}$	η	-	51	-	%
Output PAR @ 0.01% CCDF	WCDMA ³ , 2.6 GHz, $P_{OUT} = 41.5\text{ dBm}$	PAR	-	8.6	-	dB
Adjacent Channel Power	WCDMA ³ , 2.6 GHz, $P_{OUT} = 41.5\text{ dBm}$	ACP	-	-32	-	dBc
Input Return Loss	WCDMA ³ , 2.6 GHz, $P_{OUT} = 41.5\text{ dBm}$	IRL	-	-12	-	dB
Ruggedness: Output Mismatch	All phase angles	Ψ	VSWR = 10:1, No Device Damage			

RF Electrical Characteristics: $T_A = 25^\circ\text{C}$, $V_{DS} = 48\text{ V}$, $I_{DQCAR} = 100\text{ mA}$, $V_{GSPK} = -4.2\text{ V}$
Note: Performance in MACOM Doherty Production Test Fixture, $50\ \Omega$ system.

Parameter	Test Conditions	Symbol	Min.	Typ.	Max.	Units
Power Gain	WCDMA ³ , 2.7 GHz, $P_{OUT} = 41.5\text{ dBm}$	G_P	12.4	13.8	-	dB
Drain Efficiency	WCDMA ³ , 2.7 GHz, $P_{OUT} = 41.5\text{ dBm}$	η	38.5	42.5	-	%
Output PAR @ 0.01% CCDF	WCDMA ³ , 2.7 GHz, $P_{OUT} = 41.5\text{ dBm}$	PAR	6.2	7.2	-	dB
Input Return Loss	WCDMA ³ , 2.7 GHz, $P_{OUT} = 41.5\text{ dBm}$	IRL	-	-15	-6	dB

2. Pulse details: 100 μs pulse width, 10% Duty Cycle

3. Modulated Signal: 3.84 MHz, WCDMA 3GPP TM1 64 DPCH, 9.9dB PAR @ 0.01% CCDF

4. $P_{2.5dB} = P_{OUT} + 7.5\text{ dB}$ where P_{OUT} is the average output power measured using a modulated signal³ where the output PAR is compressed to 7.5 dB @ 0.01% probability CCDF.

DC Electrical Characteristics: $T_C = 25^\circ\text{C}$

Parameter	Test Conditions	Symbol	Min.	Typ.	Max.	Units
Carrier Amplifier						
Drain-Source Leakage Current	$V_{GS} = -8\text{ V}, V_{DS} = 130\text{ V}$	I_{DLK}	-	-	4.69	mA
Gate-Source Leakage Current	$V_{GS} = -8\text{ V}, V_{DS} = 0\text{ V}$	I_{GLK}	-	-	-4.69	mA
Gate Threshold Voltage	$V_{DS} = 48\text{ V}, I_D = 4.69\text{ mA}$	V_T	-3.3	-2.9	-	V
Gate Quiescent Voltage	$V_{DS} = 48\text{ V}, I_D = 100\text{ mA}$	V_{GSQ}	-	-2.6	-	V
On Resistance	$V_{GS} = 1.3\text{ V}, I_D = 46.9\text{ mA}$	R_{ON}	-	0.7	-	Ω
Maximum Drain Current	$V_{DS} = 7\text{ V}$ pulsed, pulse width 300 μs	$I_{D,MAX}$	-	5.6	-	A
Peaking Amplifier						
Drain-Source Leakage Current	$V_{GS} = -8\text{ V}, V_{DS} = 130\text{ V}$	I_{DLK}	-	-	9.0	mA
Gate-Source Leakage Current	$V_{GS} = -8\text{ V}, V_{DS} = 0\text{ V}$	I_{GLK}	-	-	-9.0	mA
Gate Threshold Voltage	$V_{DS} = 48\text{ V}, I_D = 9.0\text{ mA}$	V_T	-2.6	-2.4	-	V
Gate Quiescent Voltage	$V_{DS} = 48\text{ V}, I_D = 130\text{ mA}$	V_{GSQ}	-	-1.9	-	V
On Resistance	$V_{GS} = 1.3\text{ V}, I_D = 89.6\text{ mA}$	R_{ON}	-	0.5	-	Ω
Maximum Drain Current	$V_{DS} = 7\text{ V}$ pulsed, pulse width 300 μs	$I_{D,MAX}$	-	5.6	-	A

Absolute Maximum Ratings^{5,6,7,8,9}

Parameter	Absolute Maximum
Drain Source Voltage, V_{DS}	130 V
Gate Source Voltage, V_{GS}	-10 to 3 V
Gate Current (Carrier), I_G	9.4 mA
Gate Current (Peaking), I_G	9.0 mA
Storage Temperature Range	-65°C to +150°C
Case Operating Temperature Range	-40°C to +120°C
Channel Operating Temperature Range, T_{CH}	-40°C to +210°C
Absolute Maximum Channel Temperature	+225°C

5. Exceeding any one or combination of these limits may cause permanent damage to this device.
6. MACOM does not recommend sustained operation above maximum operating conditions.
7. Operating at drain source voltage $V_{DS} < 55$ V will ensure $MTTF > 4 \times 10^6$ hours.
8. Operating at nominal conditions with $T_{CH} \leq 225^\circ\text{C}$ will ensure $MTTF > 4 \times 10^6$ hours.
9. MTTF may be estimated by the expression $MTTF \text{ (hours)} = A e^{[B + C/(T+273)]}$ where T is the channel temperature in degrees Celsius, $A = 1.76$, $B = -33.83$, and $C = 23,476$.

Thermal Characteristics¹⁰

Parameter	Test Conditions	Symbol	Typical	Units
Thermal Resistance using Finite Element Analysis	$V_{DS} = 45$ V $T_C = 85^\circ\text{C}, T_{CH} = 225^\circ\text{C}$	$R_{\theta}(\text{FEA})$	3.9	°C/W
Thermal Resistance using Infrared Measurement of Die Surface Temperature	$V_{DS} = 45$ V $T_C = 85^\circ\text{C}, T_{CH} = 225^\circ\text{C}$	$R_{\theta}(\text{IR})$	3.0	°C/W

10. Case temperature measured using thermocouple embedded in heat-sink. Contact local applications support team for more details on this measurement.

Handling Procedures

Please observe the following precautions to avoid damage:

Static Sensitivity

Gallium Nitride Circuits are sensitive to electrostatic discharge (ESD) and can be damaged by static electricity. Proper ESD control techniques should be used when handling these devices.

Pulsed² Load-Pull Performance: Reference Plane at Device Leads

Frequency (GHz)	Z _{SOURCE} (Ω)	Carrier Amplifier: Maximum Output Power					
		V _{DS} = 45V, I _{DQ} = 90 mA, T _C = 25°C, P2.5dB					
		Z _{LOAD} ¹¹ (Ω)	Gain (dB)	P _{OUT} (dBm)	P _{OUT} (W)	η _D (%)	AM/PM (°)
2.5	14.8 - j40.0	8.0 + j3.4	17.9	46.5	45	68	-11.3
2.6	29.8 - j38.8	11.5 + j2.0	17.0	46.5	45	67	-36.2
2.7	40.6 - j27.1	10.3 - j0.9	16.5	46.5	45	63	-48.0

Frequency (GHz)	Z _{SOURCE} (Ω)	Carrier Amplifier: Maximum Drain Efficiency					
		V _{DS} = 45 V, I _{DQ} = 90mA, T _C = 25°C, P2.5dB					
		Z _{LOAD} ¹² (Ω)	Gain (dB)	P _{OUT} (dBm)	P _{OUT} (W)	η _D (%)	AM/PM (°)
2.5	21.3 - j44.9	7.8 + j8.6	19.1	45.4	35	77	-25.3
2.6	47.5 - j41.4	8.2 + j9.1	18.8	45.0	32	78	-56.9
2.7	66.0 + j10.8	5.5 + j7.8	19.7	44.1	26	81	-77.9

Frequency (GHz)	Z _{SOURCE} (Ω)	Peaking Amplifier: Maximum Output Power					
		V _{DS} = 45 V, I _{DQ} = 150 mA, T _C = 25°C, P2.5dB					
		Z _{LOAD} ¹¹ (Ω)	Gain (dB)	P _{OUT} (dBm)	P _{OUT} (W)	η _D (%)	AM/PM (°)
2.5	37.7 - j44.3	4.9 + j1.8	18.4	48.2	66	64	-28.9
2.6	78.8 - j15.1	4.1 + j0.6	18.8	48.3	68	64	-48.5
2.7	23.7 + j20.1	4.2 + j0.3	18.8	48.2	66	67	-89.2

Frequency (GHz)	Z _{SOURCE} (Ω)	Peaking Amplifier: Maximum Drain Efficiency					
		V _{DS} = 45 V, I _{DQ} = 150 mA, T _C = 25°C, P2.5dB					
		Z _{LOAD} ¹² (Ω)	Gain (dB)	P _{OUT} (dBm)	P _{OUT} (W)	η _D (%)	AM/PM (°)
2.5	63.0 - j46.7	3.6 + j4.6	19.9	46.5	45	79	-48.5
2.6	30.1 + j34.5	2.2 + j5.0	21.2	43.7	23	78	-102.4
2.7	9.8 + j12.6	2.3 + j3.7	20.2	43.9	25	76	-129.4

Impedance Reference

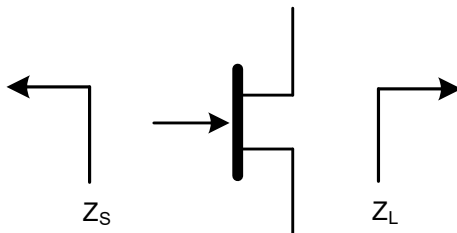

Z_{SOURCE} = Measured impedance presented to the input of the device at package reference plane.

Z_{LOAD} = Measured impedance presented to the output of the device at package reference plane.

- 11. Load Impedance for optimum output power.
- 12. Load Impedance for optimum efficiency.

Pulsed² Load-Pull Performance: Carrier Amplifier 2.6 GHz

P2.5dB Loadpull Output Power Contours (dBm)

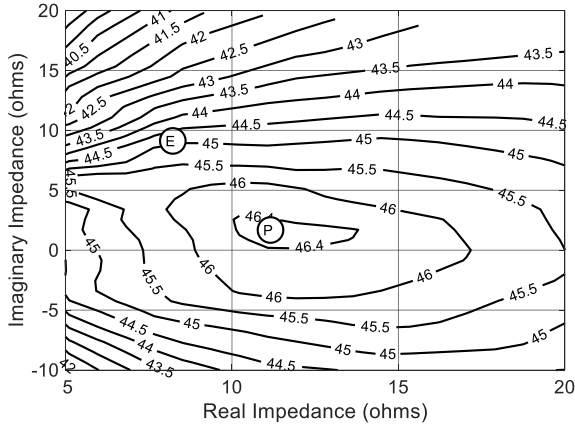

P2.5dB Loadpull Drain Efficiency Contours (%)

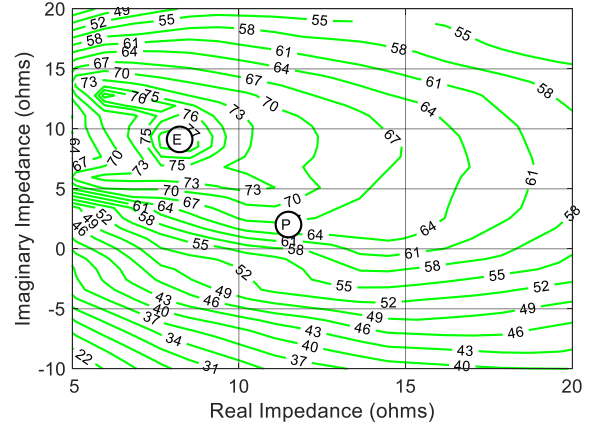

P2.5dB Loadpull Gain Contours (dB)

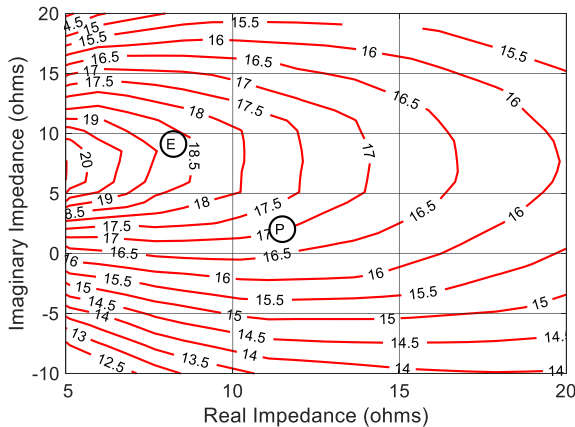

P2.5dB Loadpull AM/PM Contours (°)

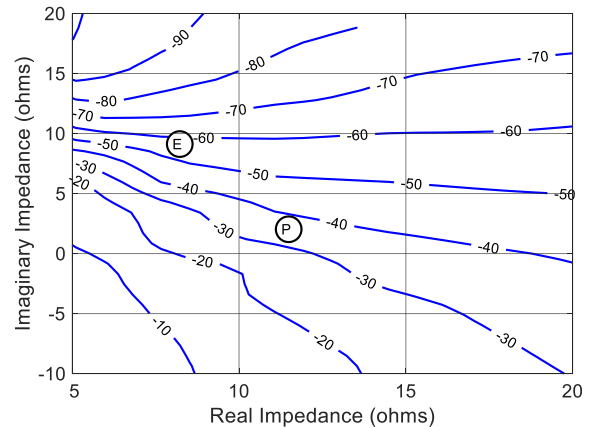

Gain vs. Output Power

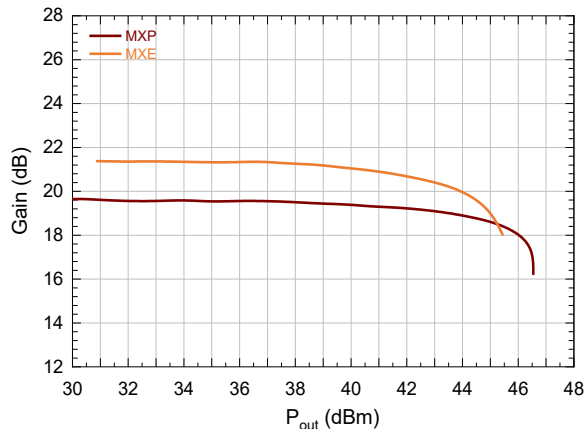

Drain Efficiency vs. Output Power

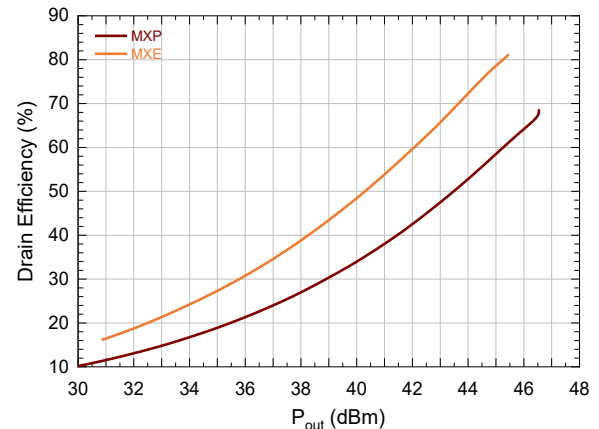

Pulsed² Load-Pull Performance: Peaking Amplifier 2.6 GHz

P2.5dB Loadpull Output Power Contours (dBm)

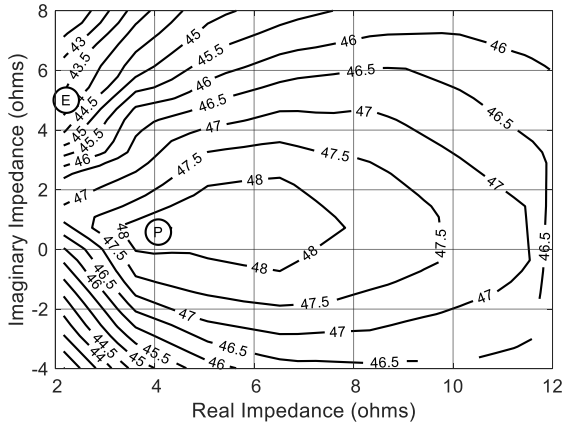

P2.5dB Loadpull Drain Efficiency Contours (%)

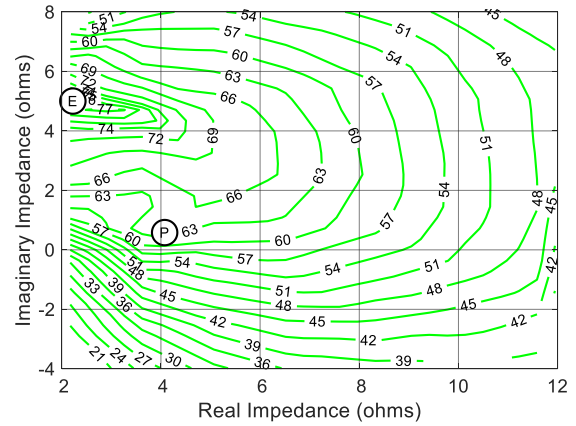

P2.5dB Loadpull Gain Contours (dB)

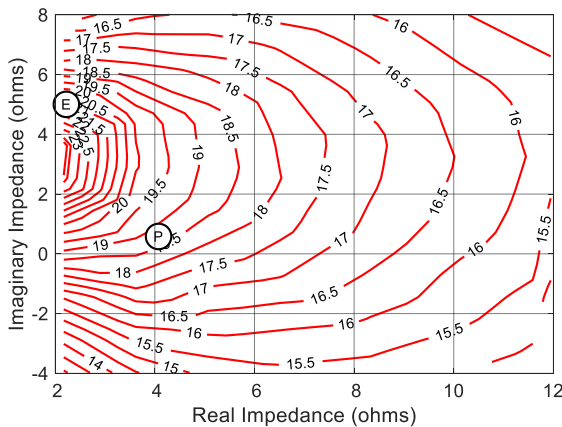

P2.5dB Loadpull AM/PM Contours (°)

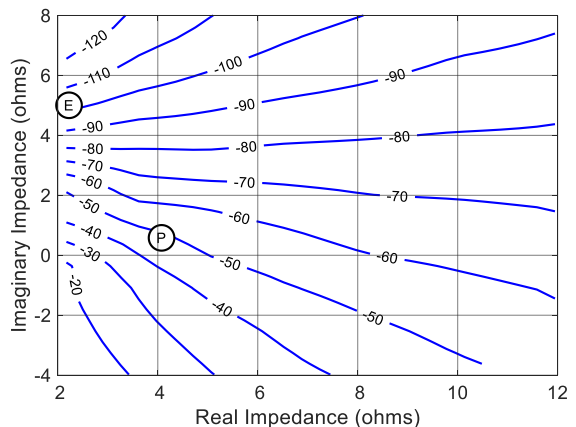

Gain vs. Output Power

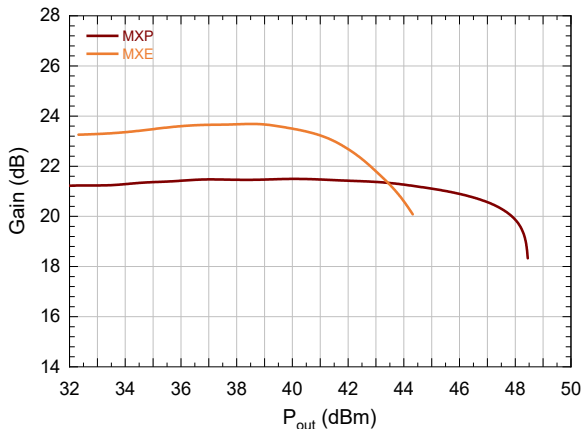

Drain Efficiency vs. Output Power

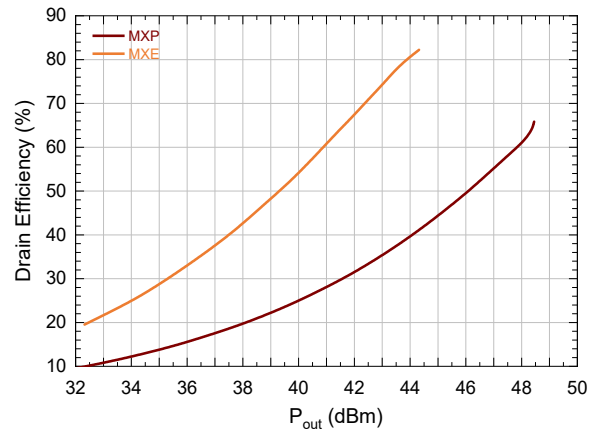

GaN Amplifier 48 V, 110 W 2.5 - 2.7 GHz



MAGB-102527-110A0P

Rev. V2

Lead-Free 7 x 10 mm 10-Lead Package Dimensions†

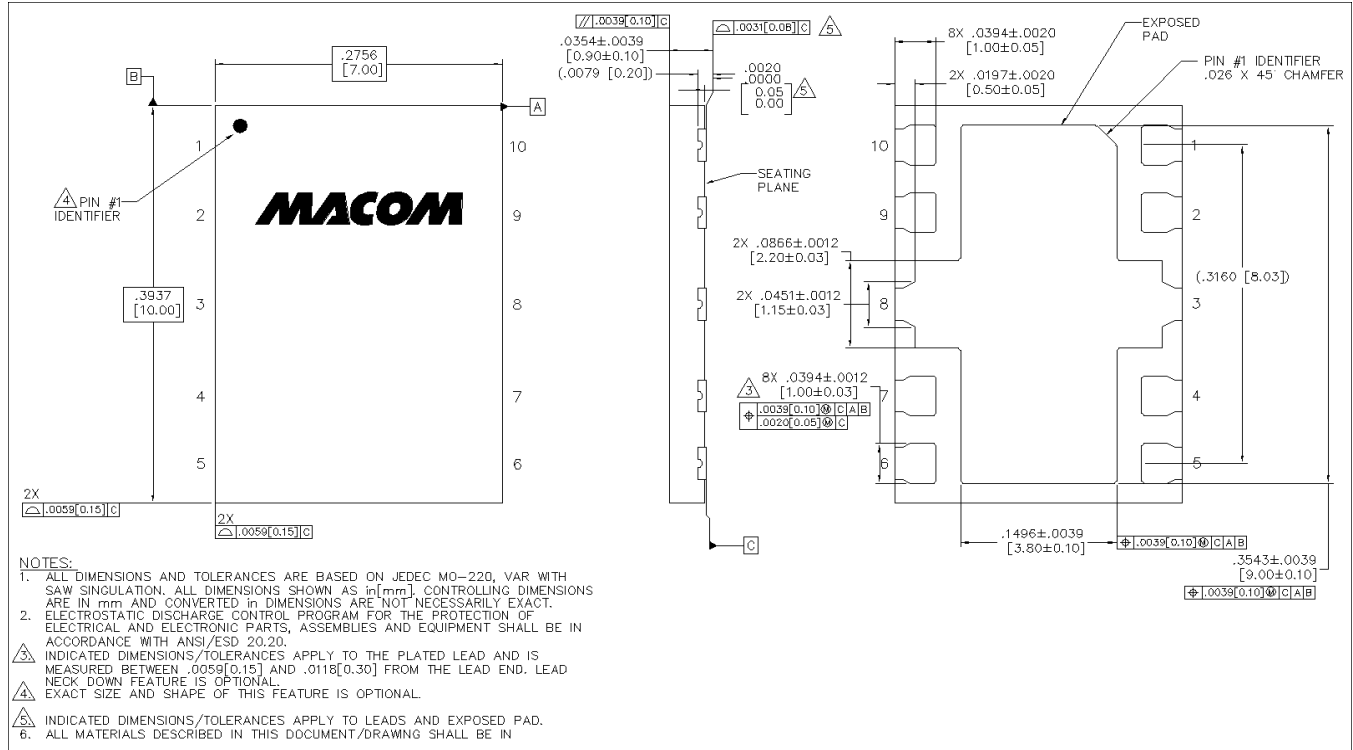

† Reference Application Note S2083 for lead-free solder reflow recommendations.
 Meets JEDEC moisture sensitivity level (MSL) 3 requirements.
 Plating is NiPdAu.

MACOM Technology Solutions Inc. ("MACOM"). All rights reserved.

These materials are provided in connection with MACOM's products as a service to its customers and may be used for informational purposes only. Except as provided in its Terms and Conditions of Sale or any separate agreement, MACOM assumes no liability or responsibility whatsoever, including for (i) errors or omissions in these materials; (ii) failure to update these materials; or (iii) conflicts or incompatibilities arising from future changes to specifications and product descriptions, which MACOM may make at any time, without notice. These materials grant no license, express or implied, to any intellectual property rights.

THESE MATERIALS ARE PROVIDED "AS IS" WITH NO WARRANTY OR LIABILITY, EXPRESS OR IMPLIED, RELATING TO SALE AND/OR USE OF MACOM PRODUCTS INCLUDING FITNESS FOR A PARTICULAR PURPOSE, MERCHANTABILITY, INFRINGEMENT OF INTELLECTUAL PROPERTY RIGHT, ACCURACY OR COMPLETENESS, OR SPECIAL, INDIRECT, INCIDENTAL, OR CONSEQUENTIAL DAMAGES WHICH MAY RESULT FROM USE OF THESE MATERIALS.

MACOM products are not intended for use in medical, lifesaving or life sustaining applications. MACOM customers using or selling MACOM products for use in such applications do so at their own risk and agree to fully indemnify MACOM for any damages resulting from such improper use or sale.