

# 0.5 W Ka-Band Power Amplifier 27 - 31.5 GHz



MAAP-011341-DIE

Rev. V2

## Features

- 27 dB Gain
- 36 dBm Output IP3
- 26.5 dBm P1dB
- 27.5 dBm P3dB
- 5.5 V Drain Supply
- Bare Die
- RoHS\* Compliant

## Applications

- Satellite Communications

## Description

The MAAP-011341-DIE is a 1/2 W Ka-band power amplifier in bare die form. The power amplifier has a 26.5 dBm typical P1dB and a 27.5 dBm typical P3dB with 27 dB of gain. The drain bias supply is 5.5 V. The gate voltage is adjusted to set the drain current to 450 mA.

This power amplifier is designed for Ka-band satellite communications applications.

## Ordering Information

Part Number	Package
MAAP-011341-DIE	Gel Pack <sup>1</sup>

1. Die quantity varies.

## Functional Diagram

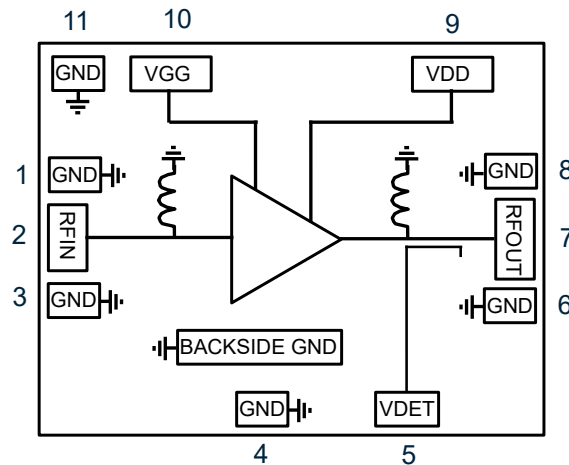

## Pin Configuration<sup>2,3</sup>

Pin #	Pin Name	Description
1,3,4,6,8,11	GND	Ground
2	RFIN	RF Input
5	VDET	Detector Voltage
7	RFOUT	RF Output
9	VDD	Drain Voltage
10	VGG	Gate Voltage

2. Pads 1, 3, 4, 6, 8, 11 are connected to ground on the die through backside vias.
3. The backside of the die must be connected to RF, DC, and thermal ground.

\* Restrictions on Hazardous Substances, compliant to current RoHS EU directive.

# 0.5 W Ka-Band Power Amplifier

## 27 - 31.5 GHz



MAAP-011341-DIE

Rev. V2

### Electrical Specifications<sup>4</sup>: VDD = +5.5 V, IDQ = 450 mA, T<sub>A</sub> = 25°C, Z<sub>0</sub> = 50 Ω

Parameter	Test Conditions	Units	Min.	Typ.	Max.
Gain	27 GHz 31.5 GHz	dB	23.5 26.5	27.0	—
Gain Flatness	27 - 31.5 GHz	dB	—	3.5	—
Input Return Loss	27 - 31.5 GHz	dB	—	10	—
Output Return Loss	27 - 31.5 GHz	dB	—	7	—
P1dB	27 - 31.5 GHz	dBm	—	26.5	—
P <sub>OUT</sub>	27 GHz, P <sub>IN</sub> = 5.0 dBm 31 GHz, P <sub>IN</sub> = 0.5 dBm	dBm	25.0 24.5	27.5	—
OIP3	27 - 31.5 GHz, P <sub>OUT</sub> = 18 dBm/tone 10 MHz Spacing	dBm	—	36	—
Noise Figure	27 - 31.5 GHz	dB	—	4.5	—
V <sub>DET</sub>	3 dBm Output Power 27 dBm Output Power	V	—	0.1 1.5	—

4. Specifications apply to MMIC die with two RF input and two RF output bond wires, and tested with 50 Ω GSG probes. No tuning applied.

### Maximum Operating Conditions

Parameter	Maximum
Input Power	8 dBm
VDD	+6 V
VGG	-3 to 0 V
Junction Temperature <sup>5,6</sup>	+160°C
Operating Temperature	-40°C to +85°C

5. Operating at nominal conditions with T<sub>J</sub> ≤ +160°C will ensure MTTF > 1 x 10<sup>6</sup> hours.

6. Junction Temp. (T<sub>J</sub>) = T<sub>C</sub> + Θ<sub>JC</sub> \* ((V \* I) - (P<sub>OUT</sub> - P<sub>IN</sub>)).  
Typical thermal resistance (Θ<sub>JC</sub>) = 29.3°C/W.

a) For T<sub>C</sub> = +85°C,  
T<sub>J</sub> = 157°C @ 5.5 V, 450 mA

### Absolute Maximum Ratings<sup>7,8</sup>

Parameter	Absolute Maximum
Input Power	10 dBm
VDD	+6.5 V
VGG	-5 to 0 V
Junction Temperature <sup>9</sup>	+175°C
Storage Temperature	-65°C to +125°C

7. Exceeding any one or combination of these limits may cause permanent damage to this device.

8. MACOM does not recommend sustained operation near these survivability limits.

9. Junction temperature directly effects device MTTF. Junction temperature should be kept as low as possible to maximize lifetime.

### Operating the MAAP-011341-DIE

#### Turn-on

1. Apply VGG (-1.5 V).
2. Apply VDD (5.5 V typical).
3. Set IDQ by adjusting VGG more positive (typically VGG ~ -0.8 V for IDQ = 450 mA).
4. Apply RFIN signal.

#### Turn-off

1. Remove RFOUT signal.
2. Decrease VGG to -1.5 V.
3. Decrease VDD to 0 V.

### Handling Procedures

Please observe the following precautions to avoid damage:

### Static Sensitivity

These electronic devices are sensitive to electrostatic discharge (ESD) and can be damaged by static electricity. Proper ESD control techniques should be used when handling these devices.

# 0.5 W Ka-Band Power Amplifier 27 - 31.5 GHz



MAAP-011341-DIE

Rev. V2

## Typical Performance Curves: VDD = 5.5 V, IDQ = 450 mA

**Small Signal Gain vs. Frequency over Temperature**

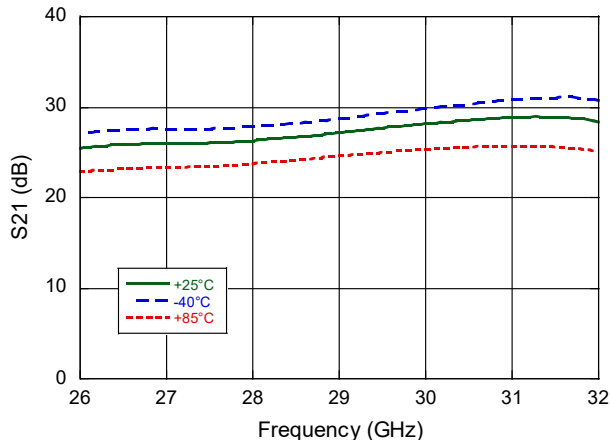

**Small Signal Gain vs. Frequency over Bias Voltage**

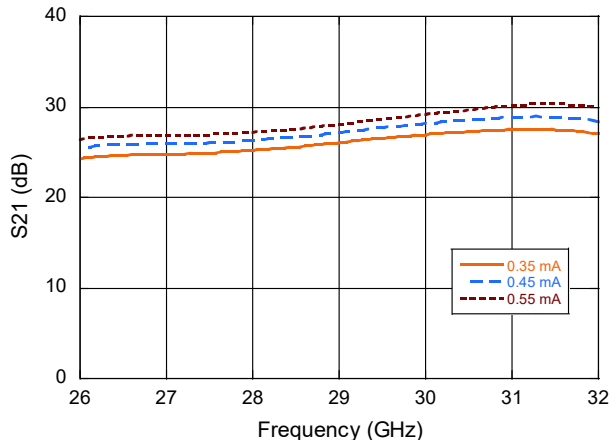

**Input Return Loss vs. Frequency over Temperature**

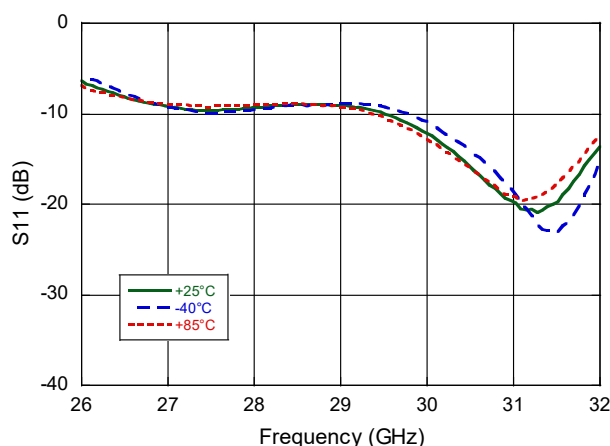

**Input Return Loss vs. Frequency over Bias Voltage**

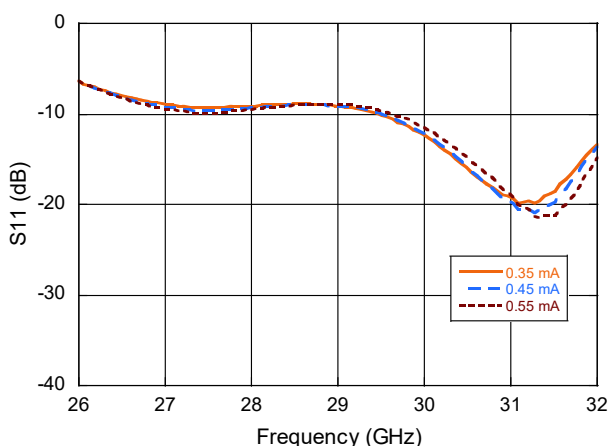

**Output Return Loss vs. Frequency over Temperature**

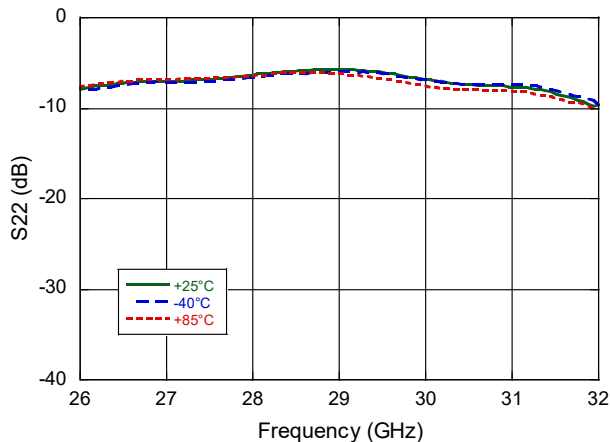

**Output Return Loss vs. Frequency over Bias Voltage**

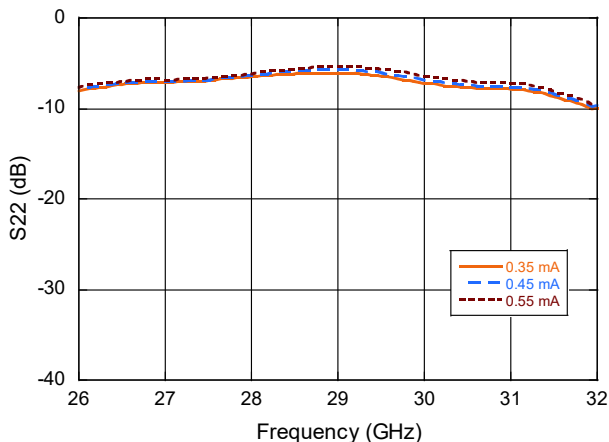

# 0.5 W Ka-Band Power Amplifier 27 - 31.5 GHz



MAAP-011341-DIE

Rev. V2

Typical Performance Curves: VDD = 5.5 V, IDQ = 450 mA

**P3dB vs. Frequency over Temperature**

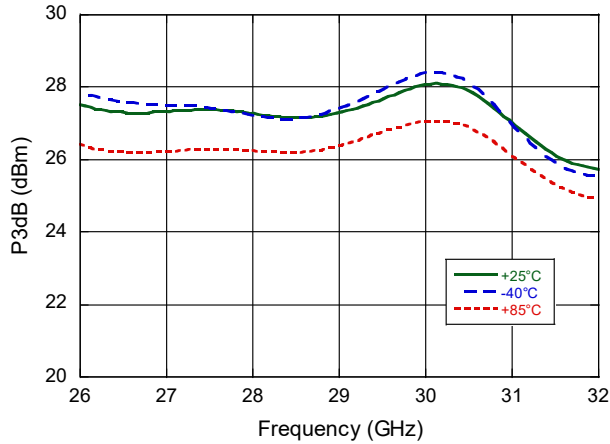

**P3dB vs. Frequency over Bias Voltage**

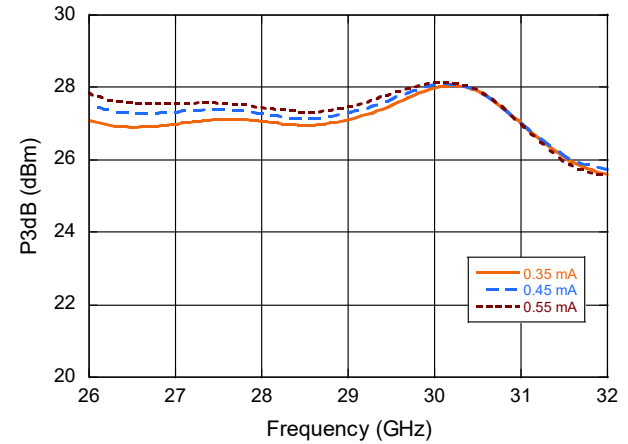

**P1dB vs. Frequency over Temperature**

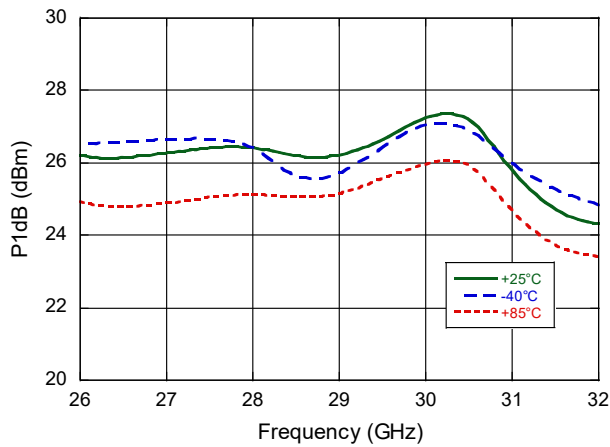

**P1dB vs. Frequency over Bias Voltage**

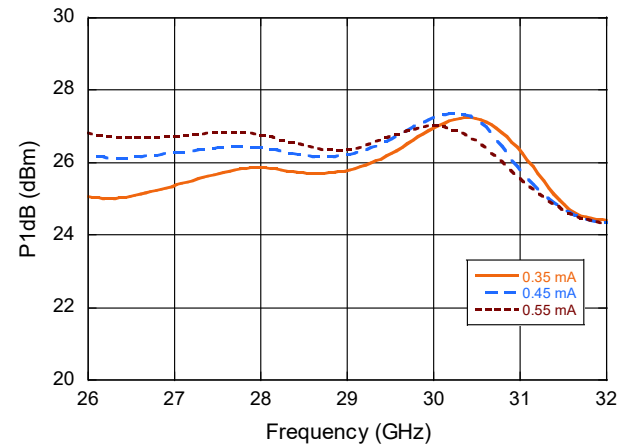

# 0.5 W Ka-Band Power Amplifier 27 - 31.5 GHz



MAAP-011341-DIE

Rev. V2

## Typical Performance Curves: VDD = 5.5 V, IDQ = 450 mA

Output IP3 vs. Output Power over Temperature @ 27 GHz

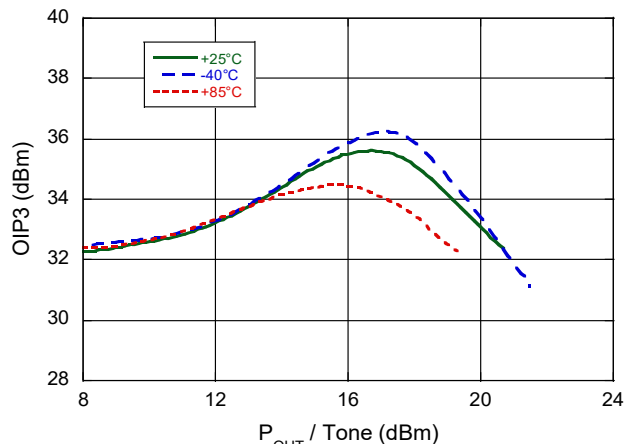

Output IP3 vs. Output Power over Temperature @ 29 GHz

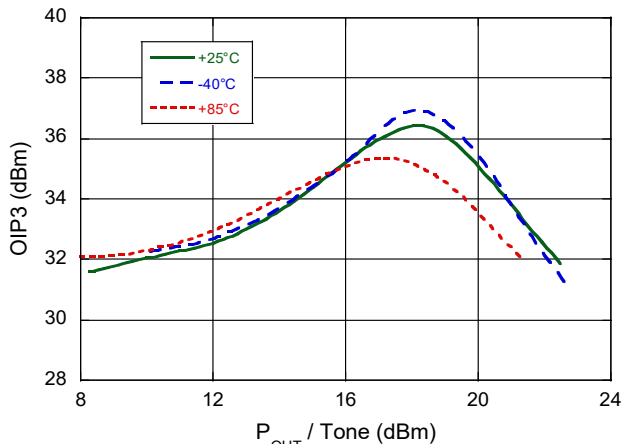

Output IP3 vs. Output Power over Temperature @ 31 GHz

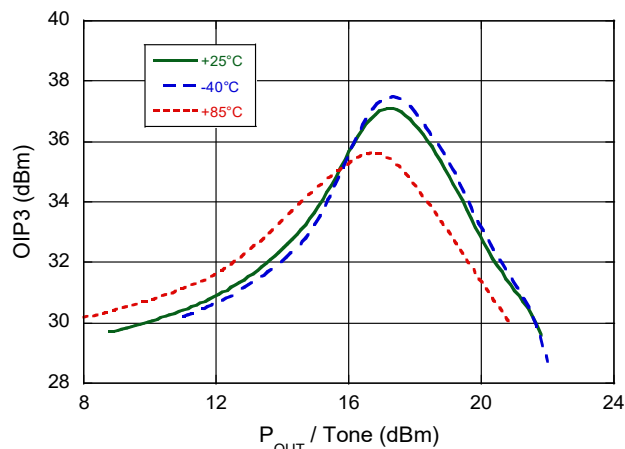

Output IP3 vs. Frequency over Temperature @ 19 dBm/TONE

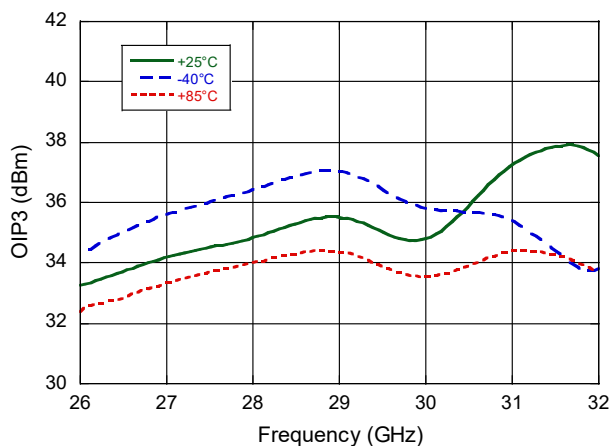

Noise Figure vs. Frequency over Temperature

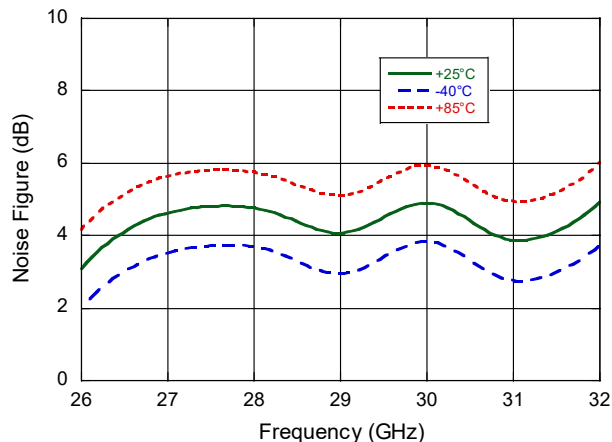

VDET vs. Output Power over Frequency

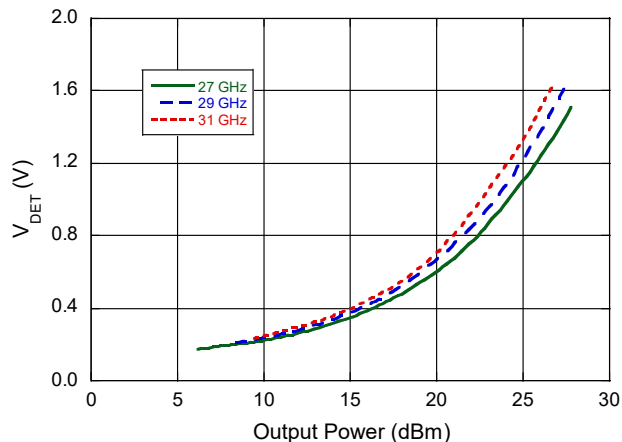

Recommended Bonding Diagram<sup>10</sup>

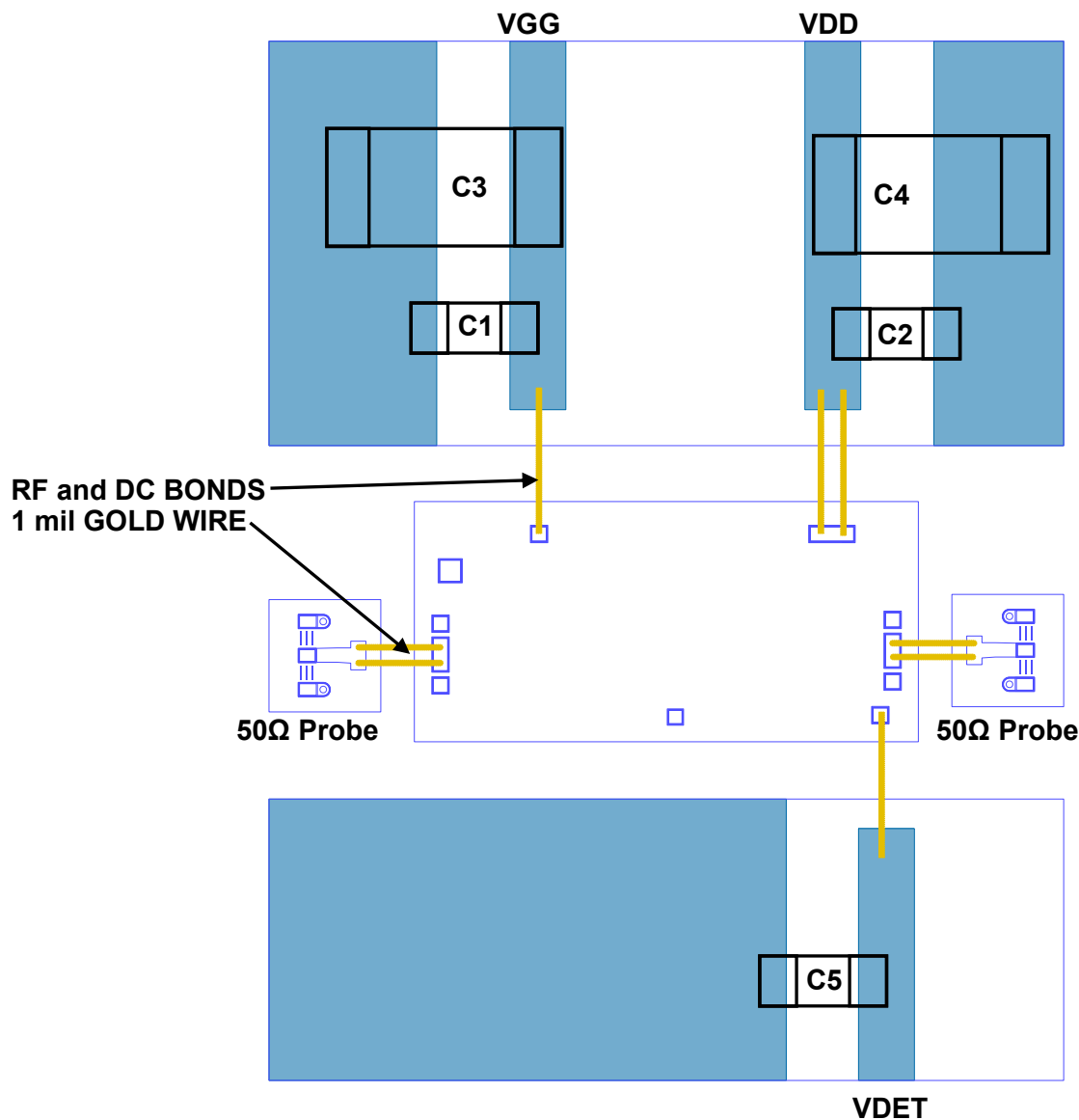

10. The 50 Ω probe stand-offs are for engineering test only. It is not necessary to wirebond the GSG ground pads 1,3,6 and 8 to ground as they are already connected to ground through backside vias.

**Die Attachment**

This product is manufactured from 0.050 mm (0.002”) thick GaAs substrate and has vias through to the backside to enable grounding to the circuit.

Recommended conductive epoxy is Namics Unimec XH9890-6. Epoxy should be applied and cured in accordance with the manufacturer’s specifications and should avoid contact with the top of the die.

**Parts List**

Part #	Value	Case Style
C1, C2	1000 pF	0402
C3, C4	10 μF	1210
C5	1 μF	0402

# 0.5 W Ka-Band Power Amplifier 27 - 31.5 GHz



MAAP-011341-DIE

Rev. V2

## MMIC Die Outline<sup>11,12</sup> (2.18 x 1.00 x 0.05 mm)

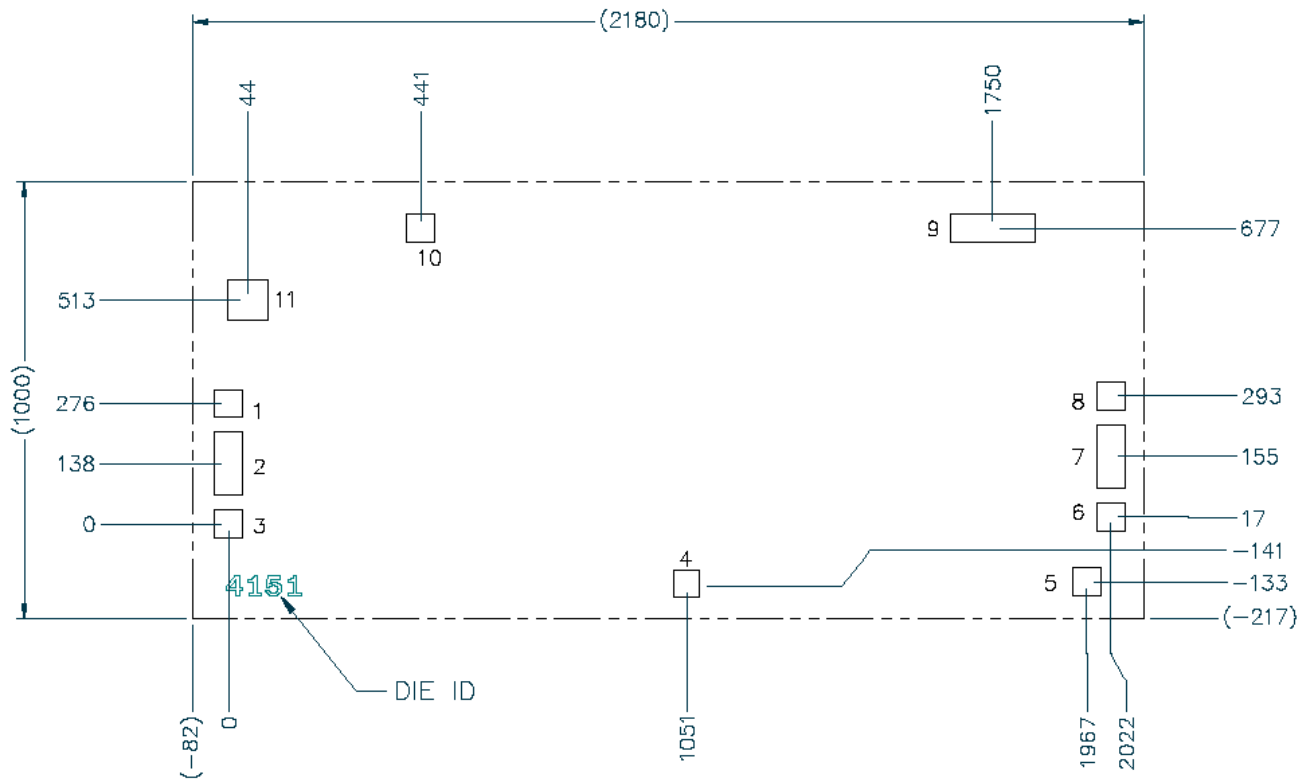

## Bond Pad Dimensions<sup>11,12</sup>

Pad #	Size (x)	Size (y)	Description
1,3,4,6,8	64	64	GND
2	64	144	RFIN
5	64	64	VDET
7	64	144	RFOUT
9	194	64	VDD
10	64	64	VGG
11	94	94	GND

11. Dimensions are in microns, unless otherwise noted.

12. GND bond pads 1,3,4,6,8,and 11 are connected to the backside of the die through via holes.

# 0.5 W Ka-Band Power Amplifier 27 - 31.5 GHz



MAAP-011341-DIE

Rev. V2

MACOM Technology Solutions Inc. ("MACOM"). All rights reserved.

These materials are provided in connection with MACOM's products as a service to its customers and may be used for informational purposes only. Except as provided in its Terms and Conditions of Sale or any separate agreement, MACOM assumes no liability or responsibility whatsoever, including for (i) errors or omissions in these materials; (ii) failure to update these materials; or (iii) conflicts or incompatibilities arising from future changes to specifications and product descriptions, which MACOM may make at any time, without notice. These materials grant no license, express or implied, to any intellectual property rights.

THESE MATERIALS ARE PROVIDED "AS IS" WITH NO WARRANTY OR LIABILITY, EXPRESS OR IMPLIED, RELATING TO SALE AND/OR USE OF MACOM PRODUCTS INCLUDING FITNESS FOR A PARTICULAR PURPOSE, MERCHANTABILITY, INFRINGEMENT OF INTELLECTUAL PROPERTY RIGHT, ACCURACY OR COMPLETENESS, OR SPECIAL, INDIRECT, INCIDENTAL, OR CONSEQUENTIAL DAMAGES WHICH MAY RESULT FROM USE OF THESE MATERIALS.

MACOM products are not intended for use in medical, lifesaving or life sustaining applications. MACOM customers using or selling MACOM products for use in such applications do so at their own risk and agree to fully indemnify MACOM for any damages resulting from such improper use or sale.