

Balanced Power Amplifier, 4 W 13.5 - 15.0 GHz



MAAP-011333-DIE

Rev. V1

Features

- High Gain: 26 dB
- P1dB: 37 dBm at 14 GHz
- P3dB: 37.8 dBm at 14 GHz
- IM3 Level: -28 dBc @ P_{OUT} 28 dBm/tone
- Power Added Efficiency: 27% at P3dB
- Die Size: 2.5 x 3.0 x 0.1 mm
- Integrated Temperature Compensated Power Detector
- Scratch Protection Die Coating
- RoHS* Compliant

Applications

- VSAT

Description

The MAAP-011333-DIE is a balanced 4 Watts power amplifier offered as a bare die part. This power amplifier operates from 13.5 to 15 GHz and provides 26 dB of linear gain and 4 W saturated output power with 27% efficiency while biased at 6 V.

The MAAP-011333-DIE can be used as a power amplifier stage or as a driver stage in higher power applications. This device is ideally suited for linear Ku-band VSAT communications.

This product is fabricated using a GaAs pHEMT process which features full passivation and scratch protection for enhanced reliability.

Ordering Information

Part Number	Package
MAAP-011333-DIE	Gel Pack
MAAP-011333-DIESMB	Sample Board

Functional Schematic

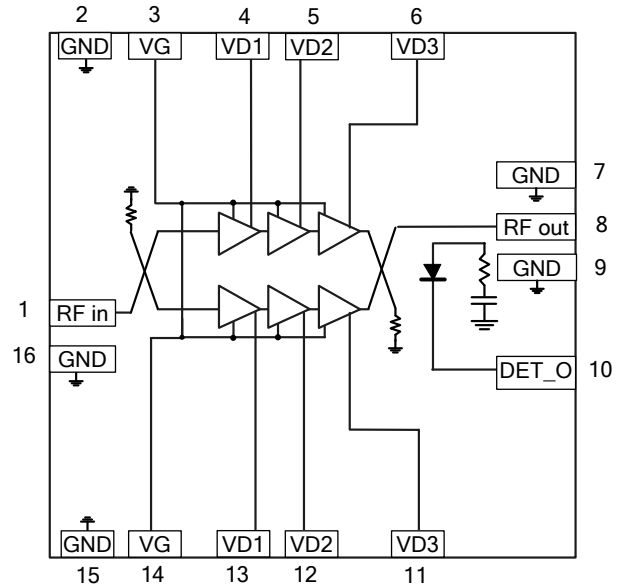

Pin Configuration¹

Pin #	Pin Name	Description
1	RF _{IN}	RF Input
2, 7, 9, 15, 16	GND	Ground
3, 14	V _G	Gate Voltage
4, 13	V _{D1}	Drain Voltage 1
5, 12	V _{D2}	Drain Voltage 2
6, 11	V _{D3}	Drain Voltage 3
8	RF _{OUT}	RF output
10	DET_O	Detector Output

1. Backside of die must be connected to RF, DC and thermal ground.

* Restrictions on Hazardous Substances, compliant to current RoHS EU directive.

Balanced Power Amplifier, 4 W

13.5 - 15.0 GHz



MAAP-011333-DIE

Rev. V1

Electrical Specifications: Freq. = 14 GHz, T_A = +25°C, V_D = +6 V, Z₀ = 50 Ω

Parameter	Test Conditions	Units	Min.	Typ.	Max.
Gain	P _{IN} = 0 dBm	dB	24	26	—
P _{OUT}	P _{IN} = +14 dBm	dBm	36	37.8	—
IM3 Level	P _{OUT} = 28 dBm / tone	dBc	—	28	—
Power Added Efficiency	P _{SAT} (P _{IN} = +14 dBm)	%	—	27	—
Input Return Loss	P _{IN} = -20 dBm	dB	—	17	—
Output Return Loss	P _{IN} = -20 dBm	dB	—	20	—
Quiescent Current	I _{DQ} (see bias conditions, page 4)	mA	—	1700	—
Current	P _{SAT} (P _{IN} = +14 dBm)	mA	—	3600	—

Maximum Operating Ratings

Parameter	Rating
Input Power	P _{IN} ≤ 3 dB Compression
Junction Temperature ^{2,3}	+160°C
Operating Temperature	-40°C to +85°C

- Operating at nominal conditions with junction temperature ≤ +160°C will ensure MTTF > 1 x 10⁶ hours.
- Junction Temperature (T_J) = T_C + Θ_{JC} * ((V * I) - (P_{out} - P_{IN}))
Typical thermal resistance (Θ_{JC}) = 3.63 °C/W.
a) For T_C = +25°C
T_J = +86.3°C @ 6 V, 3.84 A, P_{OUT} = 37.9 dBm, P_{IN} = 15 dBm
b) For T_C = +85°C
T_J = 142.3°C @ 6 V, 3.42 A, P_{OUT} = 36.8 dBm, P_{IN} = 15 dBm

Absolute Maximum Ratings^{4, 5}

Parameter	Absolute Maximum
Input Power	+30 dBm
Drain Voltage	+6.5 V
Gate Voltage	-3 to 0 V
Junction Temperature ⁶	+175°C
Storage Temperature	-65°C to +150°C

- Exceeding any one or combination of these limits may cause permanent damage to this device.
- MACOM does not recommend sustained operation near these survivability limits.
- Junction temperature directly effects device MTTF. Junction temperature should be kept as low as possible to maximize lifetime.

Handling Procedures

Please observe the following precautions to avoid damage:

Static Sensitivity

These electronic devices are sensitive to electrostatic discharge (ESD) and can be damaged by static electricity. Proper ESD control techniques should be used when handling these HBM Class 1A devices.

Balanced Power Amplifier, 4 W 13.5 - 15.0 GHz



MAAP-011333-DIE

Rev. V1

Sample Board Layout

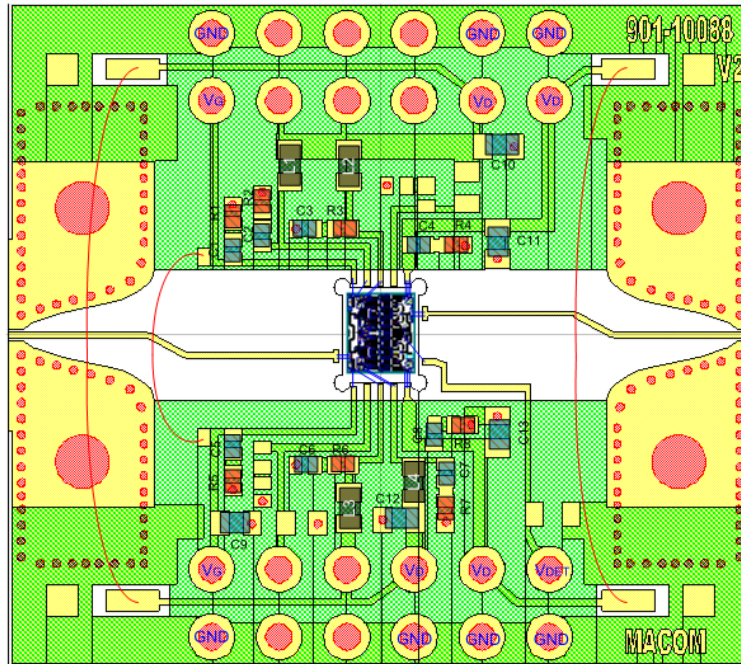

Application Schematic

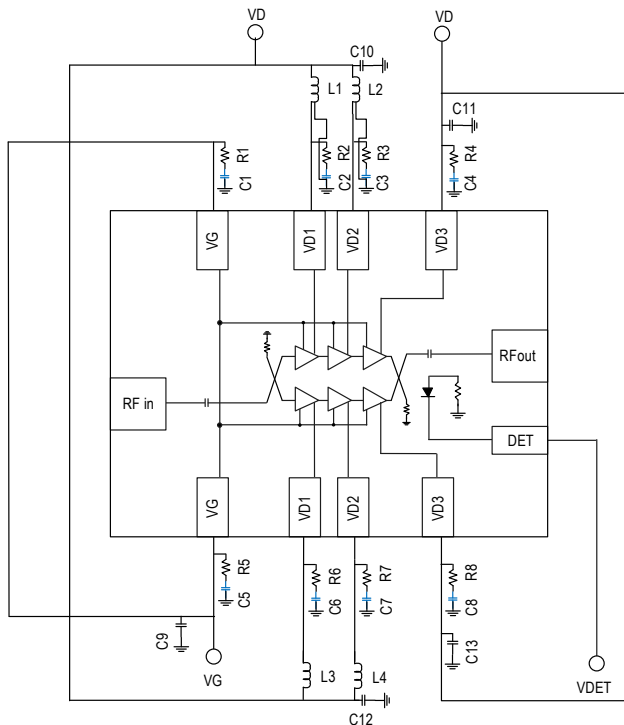

Parts List

Part	Value	Case Style
C1 - C8	0.01 μ F	0402
C9 - C13	22 μ F	0603
R1 - R8	10 Ω	0402
L1 - L4	Ferrite Bead MURATA BLM18HE601SN1D	0603

Sample Board Thru Loss

Refer to the plot on page 6 for sample board thru losses.

Sample Board Material Specifications

Top Layer: 1/2 oz Copper Cladding, 0.0175 mm thickness
Dielectric Layer: Rogers RO4350B 0.101 mm thickness
Bottom Layer: 1/2 oz Copper Cladding, 0.0175 mm thickness
Finished overall thickness: 0.136 mm

Recommended Bonding Diagram and PCB Details:

For optimum performance, RF input and output microstrip lines require open stubs on the application board for bonding wire inductance compensation. Optimum bonding wire inductance for the RF I/O connection is 0.2 nH and physical length for the 1 mil diameter gold wire is approximately 350 μm each for the two wire connection.

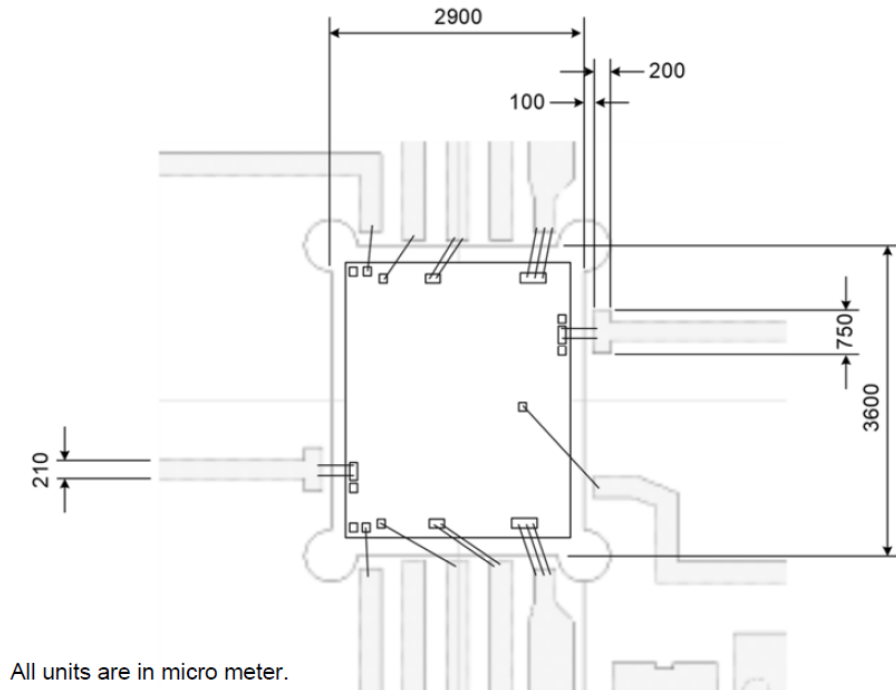

Biasing conditions

Recommended biasing conditions are $V_D = 6\text{ V}$, $I_{DQ} = 1.7\text{ A}$ (controlled with V_G). The drain bias voltage range is 4 to 6 V, and the quiescent drain current biasing range is 1.5 to 2.5 A.

V_G pins 2 and 13 are internally connected; therefore, interconnection is not required. Muting can be accomplished by setting the V_G to the pinched off voltage ($V_G = -2\text{ V}$).

V_D Bias must be applied to V_{D1} , V_{D2} and V_{D3} pins from north and south sides. North V_D supplies and south V_D supplies are not connected internally.

Operating the MAAP-011333-DIE

Turn-on

1. Apply V_G (-1.5 V).
2. Apply V_D (6.0 V typical).
3. Set I_{DQ} by adjusting V_G more positive (typically -0.9 to -1.0 V for $I_{DQ} = 1.7\text{ A}$).
4. Apply RF_{IN} signal.

Turn-off

1. Remove RF_{IN} signal.
2. Decrease V_G to -1.5 V.
3. Decrease V_D to 0 V.

Balanced Power Amplifier, 4 W 13.5 - 15.0 GHz



MAAP-011333-DIE

Rev. V1

Typical Performance Curves: $V_D = 6\text{ V}$, $I_{DSQ} = 1700\text{ mA}$

Small Signal Gain vs. Frequency over Temperature

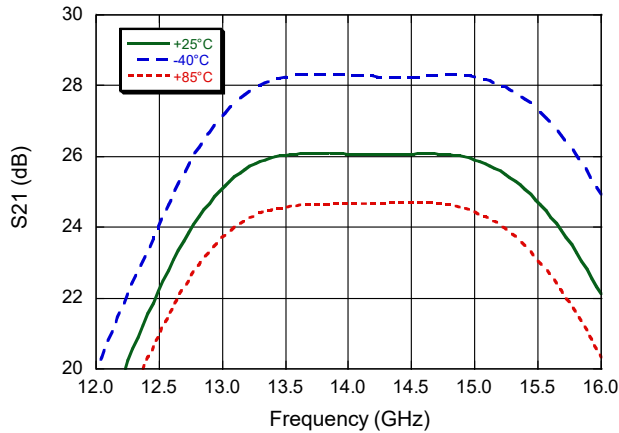

Small Signal Gain vs. Frequency over Bias Voltage

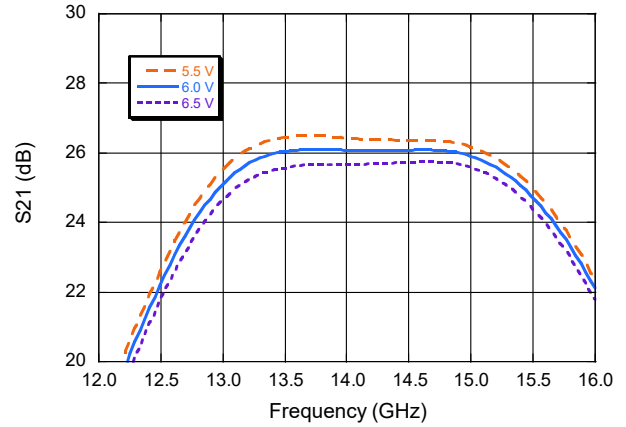

Input Return Loss vs. Frequency over Temperature

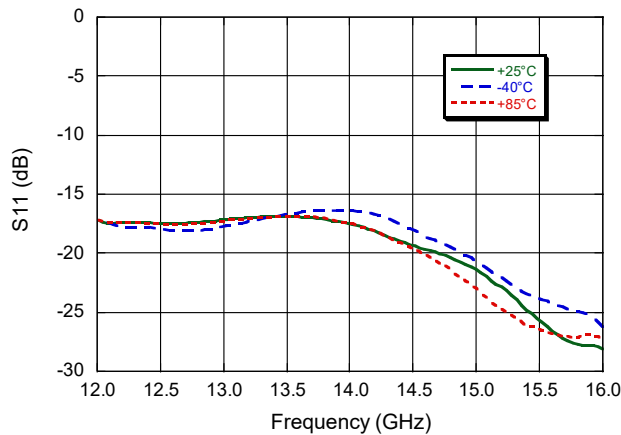

Input Return Loss vs. Frequency over Bias Voltage

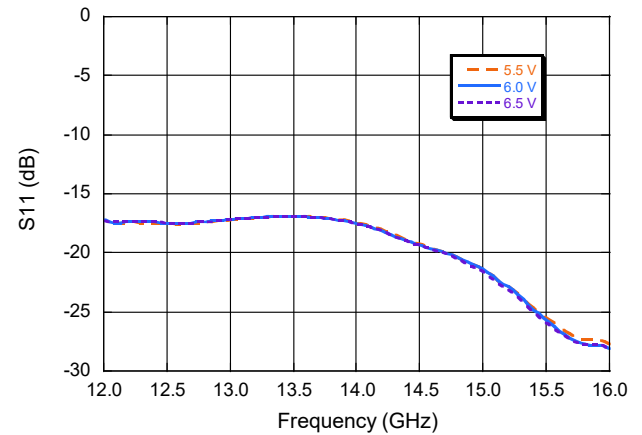

Output Return Loss vs. Frequency over Temperature

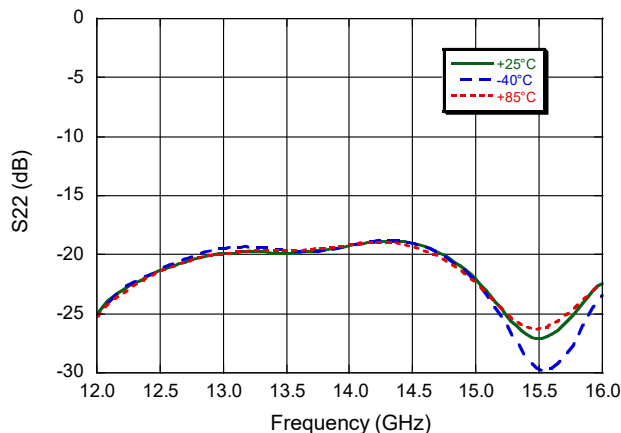

Output Return Loss vs. Frequency over Bias Voltage

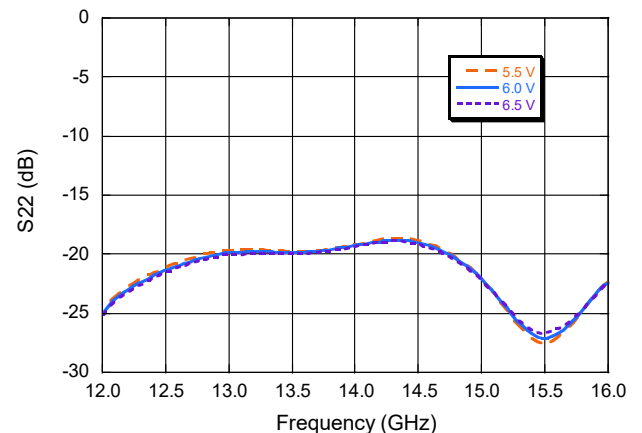

Balanced Power Amplifier, 4 W 13.5 - 15.0 GHz



MAAP-011333-DIE

Rev. V1

Typical Performance Curves: $V_D = 6\text{ V}$, $I_{DSQ} = 1700\text{ mA}$

P3dB vs. Frequency over Temperature

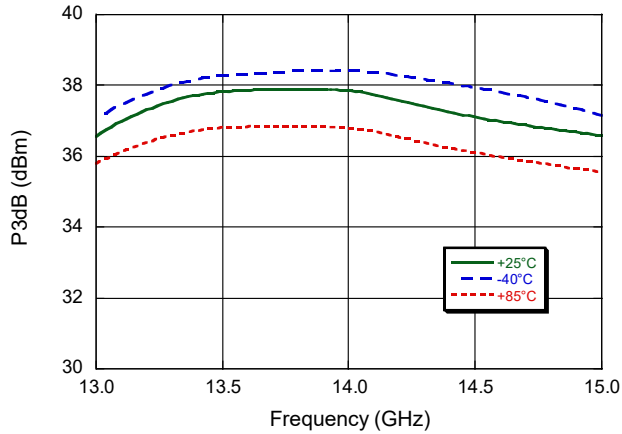

P3dB vs. Frequency over Bias Voltage

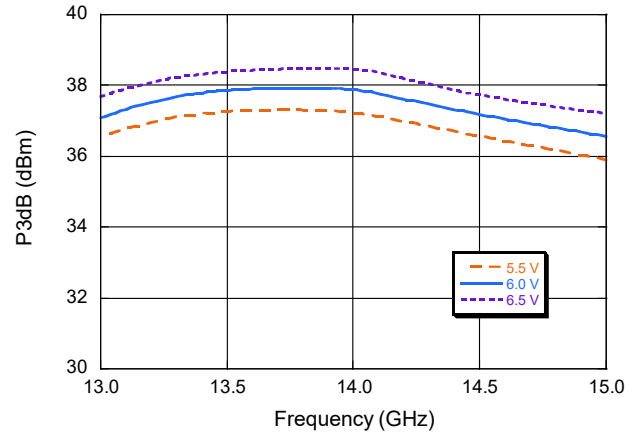

P1dB vs. Frequency over Temperature

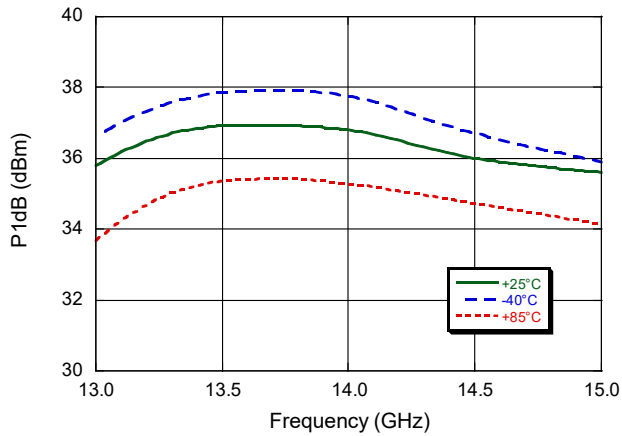

P1dB vs. Frequency over Bias Voltage

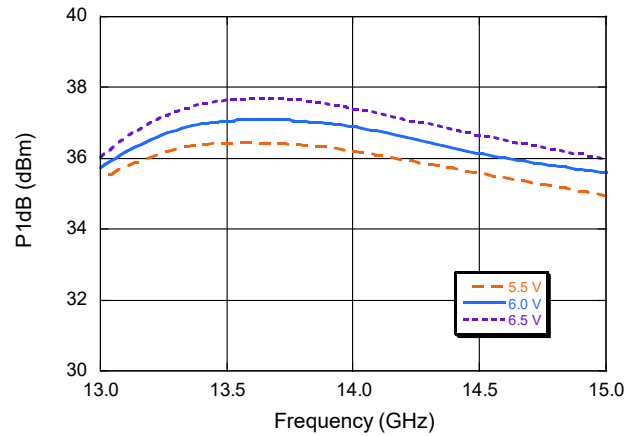

**Sample Board Thru Loss
Includes Two 2.4mm Connectors**

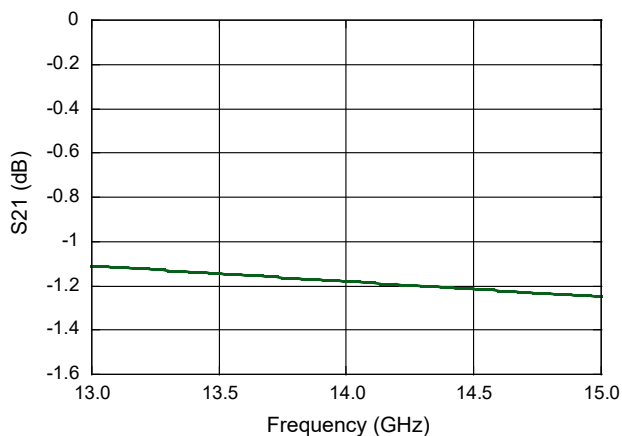

Balanced Power Amplifier, 4 W 13.5 - 15.0 GHz



MAAP-011333-DIE

Rev. V1

Typical Performance Curves: $V_D = 6\text{ V}$, $I_{DSQ} = 1700\text{ mA}$

IM3 vs. Output Power by Temperature @ 13.75 GHz

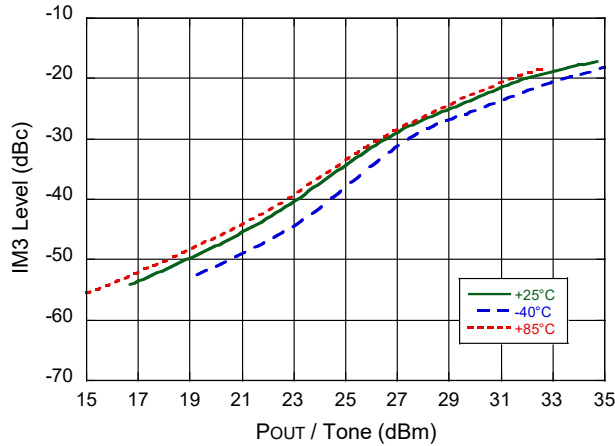

IM3 vs. Output Power by Frequency

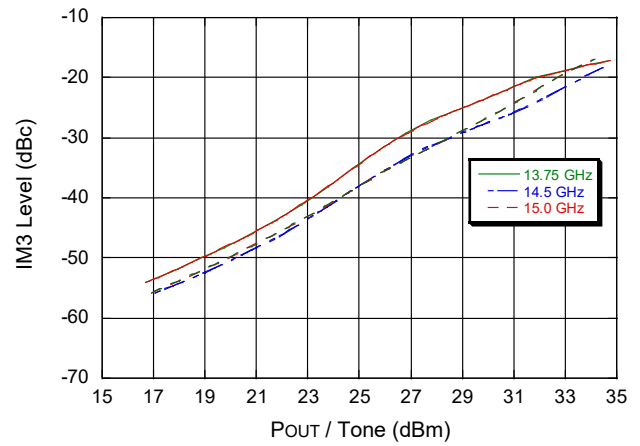

IM3 vs. Output Power by Temperature @ 14.5 GHz

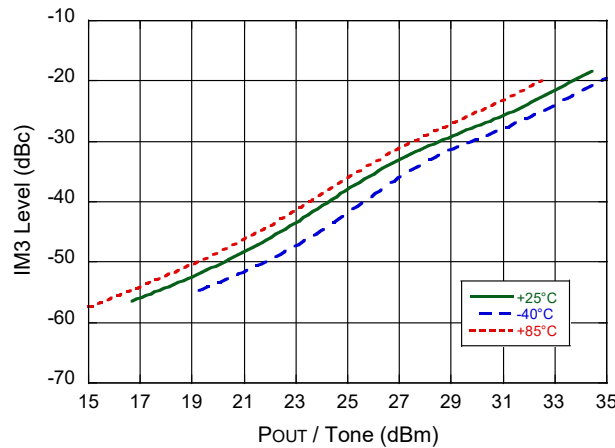

IM3 vs. Frequency @ Output Power = 28 dBm/tone

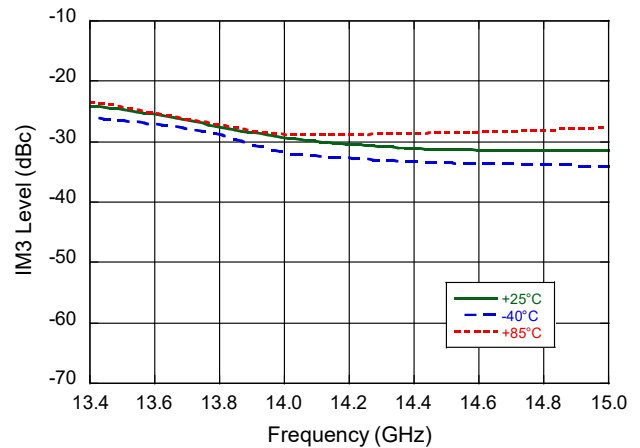

IM3 vs. Output Power by Temperature @ 15 GHz

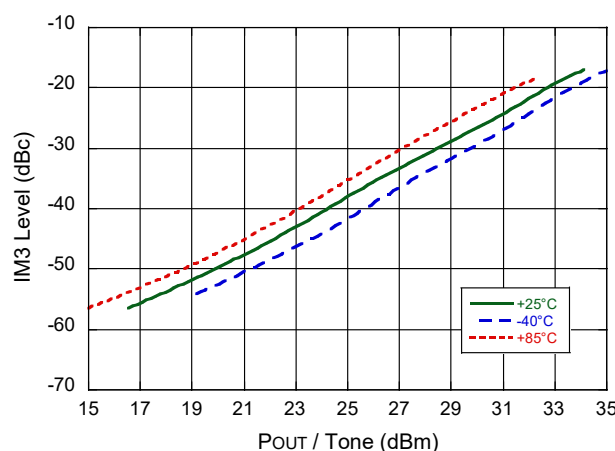

Output IP3 vs. Output Power by Frequency

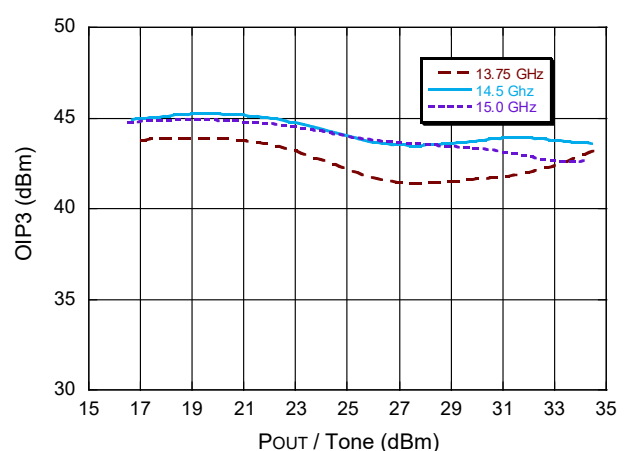

Balanced Power Amplifier, 4 W 13.5 - 15.0 GHz



MAAP-011333-DIE

Rev. V1

Typical Performance Curves: $V_D = 6\text{ V}$

IM3 vs. Output Power by Drain Current @ 13.75 GHz

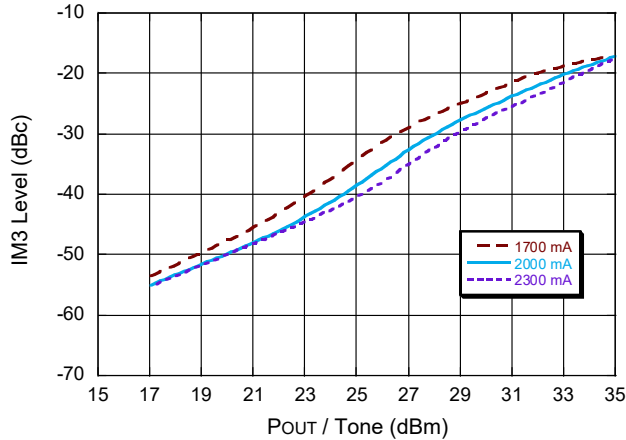

IM3 vs. Frequency by Drain Current @ $P_{out} = 28\text{ dBm/ tone}$

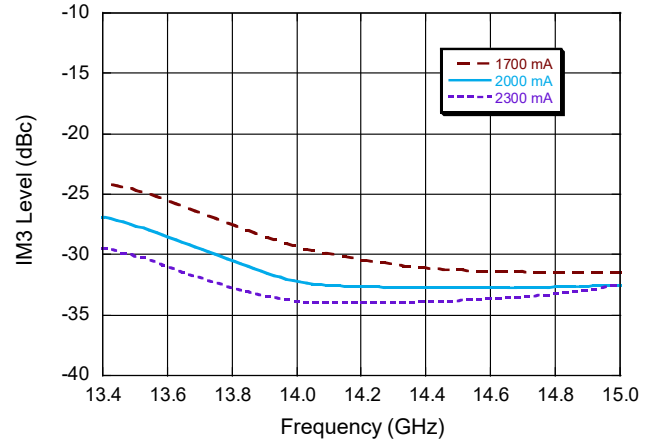

IM3 vs. Output Power by Drain Current @ 14.5 GHz

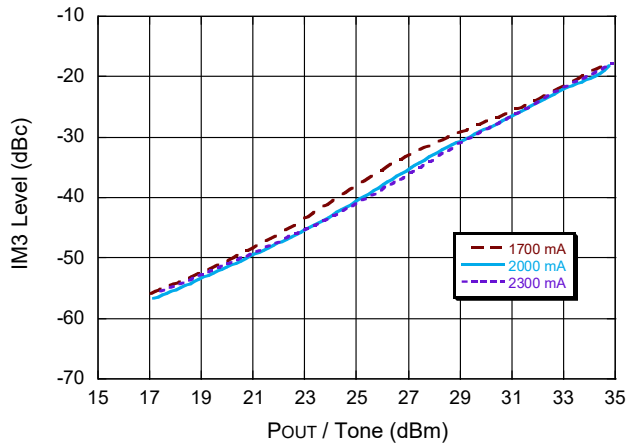

Output IP3 vs. Output Power by Drain Current @ 14.5 GHz

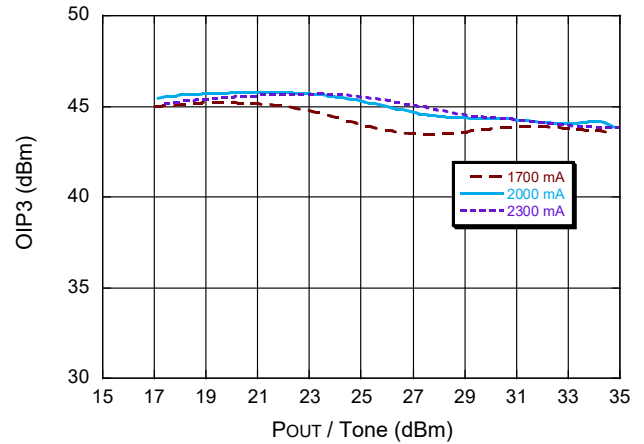

IM3 vs. Output Power by Drain Current @ 15 GHz

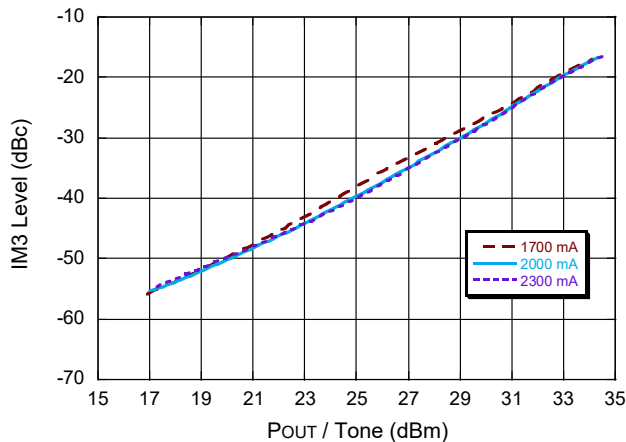

Balanced Power Amplifier, 4 W 13.5 - 15.0 GHz



MAAP-011333-DIE

Rev. V1

Typical Performance Curves: $V_D = 6\text{ V}$, $I_{DSQ} = 1700\text{ mA}$

Output Power vs. Input Power

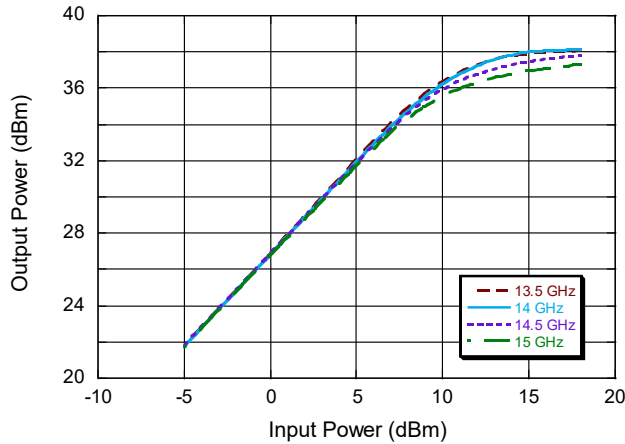

Gain and PAE @ P3dB vs. Frequency

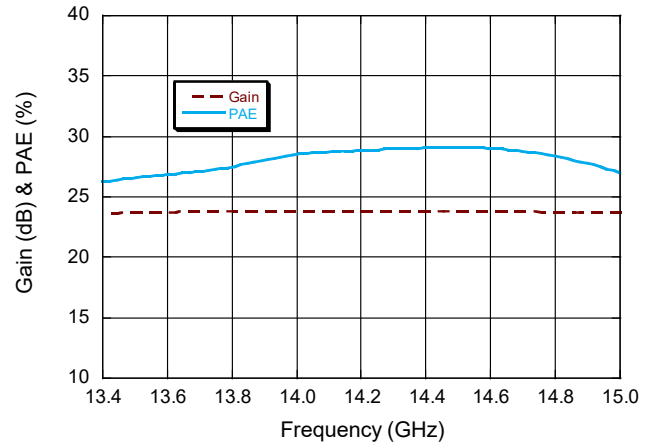

Drain Current vs. Input Power

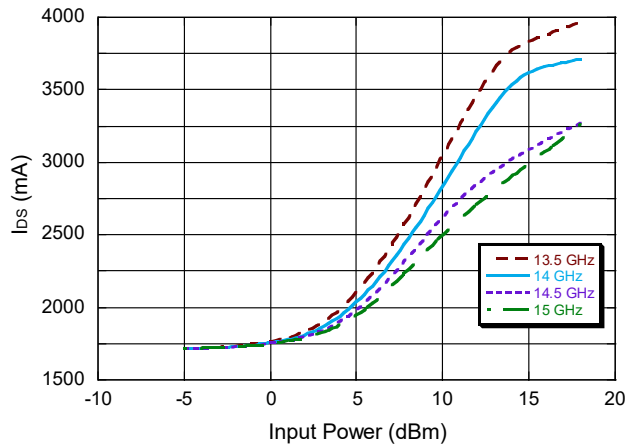

PAE vs. Input Power

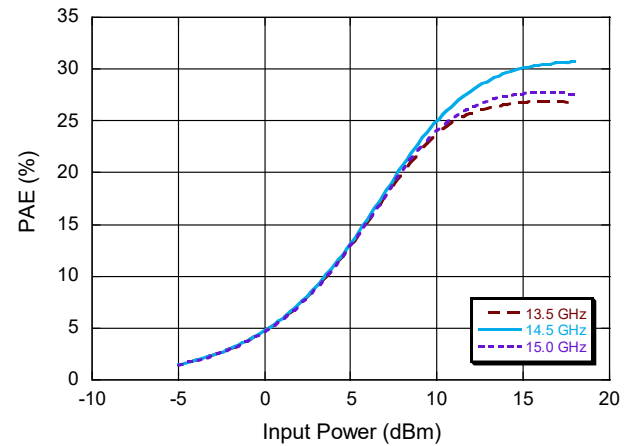

Gate Current vs. Frequency @ P_{SAT}

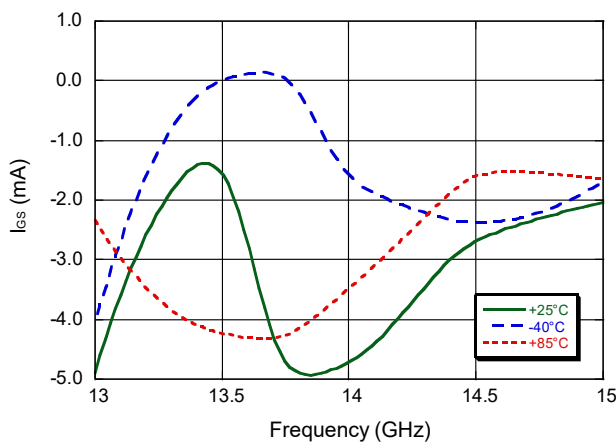

Detector Voltage vs. Output Power @ 14 GHz

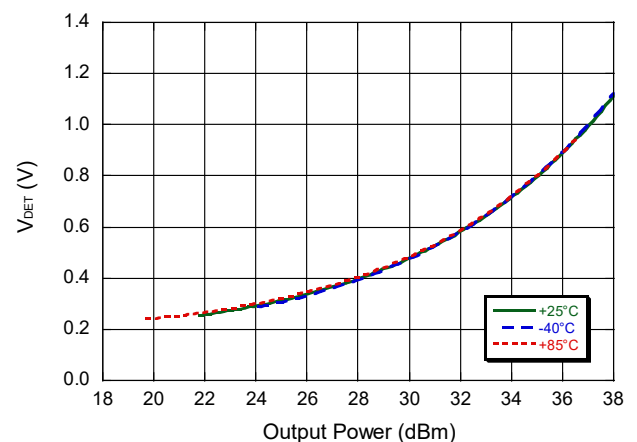

Balanced Power Amplifier, 4 W 13.5 - 15.0 GHz



MAAP-011333-DIE

Rev. V1

MMIC Die Outline^{7,8}

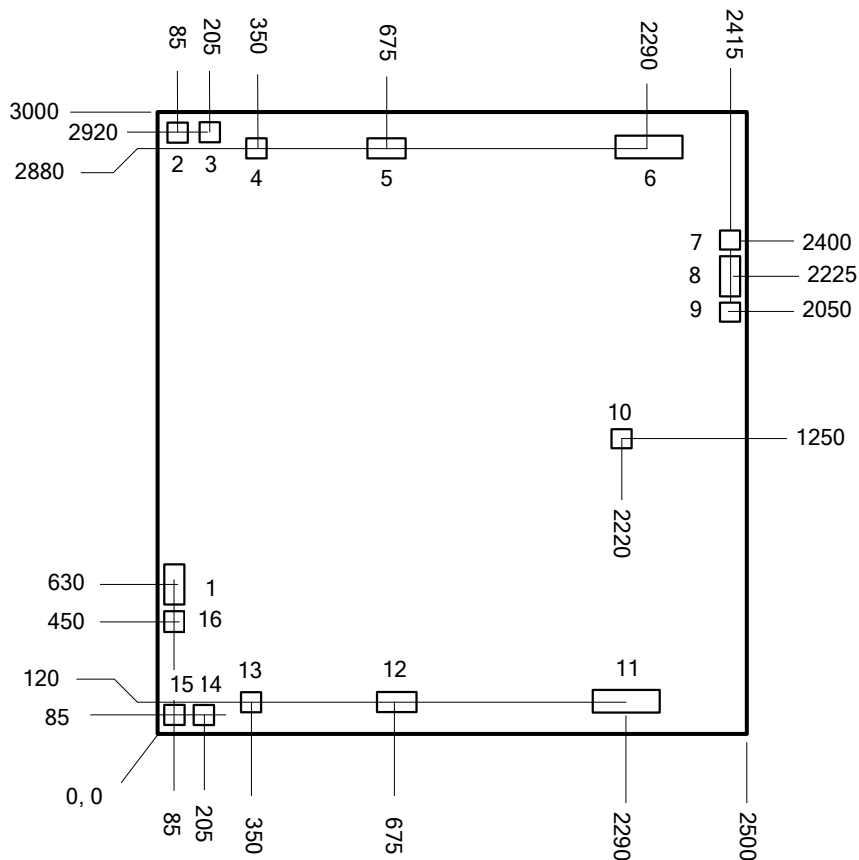

7. All units are in μm , unless otherwise noted, with a tolerance of $\pm 5 \mu\text{m}$.

8. Die thickness is $100 \pm 10 \mu\text{m}$.

Bond Pad Detail⁹

Pad	Size (x)	Size (y)
1, 8	100	200
3, 14	90	90
4, 13	100	100
5, 12	160	100
6, 11	240	100
10	75	75

9. Pin 2, 7, 9, 15, and 16 are not in use.

Balanced Power Amplifier, 4 W 13.5 - 15.0 GHz



MAAP-011333-DIE

Rev. V1

MACOM Technology Solutions Inc. All rights reserved.

Information in this document is provided in connection with MACOM Technology Solutions Inc ("MACOM") products. These materials are provided by MACOM as a service to its customers and may be used for informational purposes only. Except as provided in MACOM's Terms and Conditions of Sale for such products or in any separate agreement related to this document, MACOM assumes no liability whatsoever. MACOM assumes no responsibility for errors or omissions in these materials. MACOM may make changes to specifications and product descriptions at any time, without notice. MACOM makes no commitment to update the information and shall have no responsibility whatsoever for conflicts or incompatibilities arising from future changes to its specifications and product descriptions. No license, express or implied, by estoppel or otherwise, to any intellectual property rights is granted by this document.

THESE MATERIALS ARE PROVIDED "AS IS" WITHOUT WARRANTY OF ANY KIND, EITHER EXPRESS OR IMPLIED, RELATING TO SALE AND/OR USE OF MACOM PRODUCTS INCLUDING LIABILITY OR WARRANTIES RELATING TO FITNESS FOR A PARTICULAR PURPOSE, CONSEQUENTIAL OR INCIDENTAL DAMAGES, MERCHANTABILITY, OR INFRINGEMENT OF ANY PATENT, COPYRIGHT OR OTHER INTELLECTUAL PROPERTY RIGHT. MACOM FURTHER DOES NOT WARRANT THE ACCURACY OR COMPLETENESS OF THE INFORMATION, TEXT, GRAPHICS OR OTHER ITEMS CONTAINED WITHIN THESE MATERIALS. MACOM SHALL NOT BE LIABLE FOR ANY SPECIAL, INDIRECT, INCIDENTAL, OR CONSEQUENTIAL DAMAGES, INCLUDING WITHOUT LIMITATION, LOST REVENUES OR LOST PROFITS, WHICH MAY RESULT FROM THE USE OF THESE MATERIALS.

MACOM products are not intended for use in medical, lifesaving or life sustaining applications. MACOM customers using or selling MACOM products for use in such applications do so at their own risk and agree to fully indemnify MACOM for any damages resulting from such improper use or sale.