

# LO Buffer Amplifier

## 27 - 42 GHz



MAAM-011337

Rev. V1

### Features

- Gain: 23 dB
- Output P1dB: 20 dBm
- Output Power: 23 dBm with Input Power: 3 dBm
- Drain Supply: 5 V
- Lead-Free 2 mm, 8 lead PDFN Package
- RoHS\* Compliant

### Applications

- ISM
- Multimarket

### Description

The MAAM-011337 is a Ka-band LO buffer amplifier with an operating frequency range of 27 to 42 GHz. This amplifier typically has 23 dB gain, 20 dBm P1dB, and 23 dBm output power with 3 dBm input power. A 5 V supply voltage is required and the typical current draw is only 220 mA.

The MAAM-011337 is designed for Ka-band low noise applications. The 2 mm, 8 lead PDFN package is lead free and RoHS compliant.

### Block Diagram

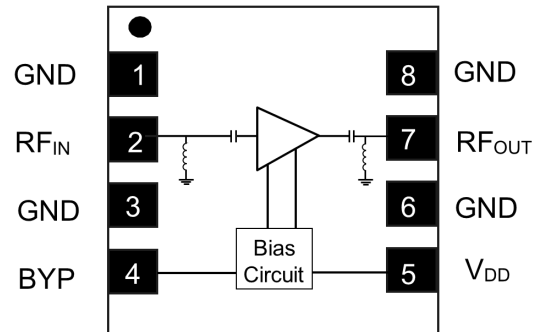

### Pin Names<sup>1,2</sup>

Pin #	Function
1, 3, 6, 8	Ground
2	RF Input
4	Bypass
5	+5 V Voltage Supply
7	RF Output

1. MACOM recommends connecting unused package pins to ground.
2. The exposed pad centered on the package bottom must be connected to RF, DC and thermal ground.

### Ordering Information

Part Number	Package
MAAM-011337-TR1000	1000 piece reel
MAAM-011337-TR3000	3000 piece reel
MAAM-011337-SMB	Sample Board

\* Restrictions on Hazardous Substances, compliant to current RoHS EU directive.

### Pin Description

Pin #	Name	description
1, 3, 6, 8	GND	RF and DC Ground. Fused to paddle internally.
2	RF <sub>IN</sub>	RF Input. DC shorted to ground.
4	BYP	Requires bypass capacitor.
5	V <sub>DD</sub>	+5 V Supply Pin. Requires bypass capacitor.
7	RF <sub>OUT</sub>	RF Output. DC shorted to ground.

**AC Electrical Specifications: Freq. = 27 - 42 GHz,  $T_C = 25^\circ\text{C}$ ,  $V_{DD} = +5\text{ V}$ ,  $Z_0 = 50\ \Omega$**

Parameter	Test Conditions	Units	Min.	Typ.	Max.
Gain	$P_{IN} = -20\text{ dBm}$ , 27 GHz 32 GHz 37 GHz 42 GHz	dB	17.0 14.0 18.0 17.0	22.5 22.0 24.5 23.5	—
Gain Flatness	$P_{IN} = -20\text{ dBm}$	dB	—	+/-2	—
Input Return Loss	$P_{IN} = -20\text{ dBm}$	dB	—	14	—
Output Return Loss	$P_{IN} = -20\text{ dBm}$	dB	—	10	—
P1dB	—	dBm	—	20	—
Output Power	$P_{IN} = 3\text{ dBm}$ 27 GHz 32 GHz 37 GHz 42 GHz	dBm	18.0 17.5 18.0 19.0	22.5 22.0 22.5 23.5	—
Power Flatness	$P_{IN} = 3\text{ dBm}$	dB	—	+/-0.5	—
Phase Noise	10 kHz offset	dBc/Hz	—	-130	—
IP3	$P_{IN} = -22\text{ dBm/}$ tone, 10 MHz Spacing	dBm	—	29	—

**DC Electrical Specifications:  $V_{CC} = +5\text{ V}$ ,  $T_C = 25^\circ\text{C}$**

Parameter	Test Conditions	Units	Min.	Typ.	Max.
DC Current $I_{DQ}$ $I_{DD}$	$P_{IN} = -20\text{ dBm}$ $P_{IN} = 3\text{ dBm}$	mA	—	220 300	450 —

### Recommended Operating Conditions

Parameter	Symbol	Unit	Min.	Typ.	Max.
RF Input Power	-	dBm	-25	3	5
DC Supply	V <sub>DD</sub>	V	4	5	5.5
Junction Temperature	T <sub>J</sub>	°C	—	—	+160
Operating Temperature <sup>9</sup>	T <sub>C</sub>	°C	-40	—	+85

### Absolute Maximum Ratings<sup>5,6</sup>

Parameter	Symbol	Unit	Min.	Max.
RF Input Power	-	dBm	—	24
DC Supply	V <sub>DD</sub>	V	—	6.5
Junction Temperature <sup>7,8</sup>	T <sub>J</sub>	°C	—	+170
Operating Temperature <sup>9,10</sup>	T <sub>C</sub>	°C	-55	+125
Storage Temperature	-	°C	-55	+150

5. Exceeding any one or combination of these limits may cause permanent damage to this device.

6. MACOM does not recommend sustained operation near these survivability limits.

7. Operating at nominal conditions with T<sub>J</sub> ≤ +160C will ensure MTTF > 1 x 10<sup>6</sup> hours.

8. Junction Temperature (T<sub>J</sub>) = T<sub>C</sub> + Θ<sub>Jc</sub> \* ((V \* I) - (P<sub>OUT</sub> - P<sub>IN</sub>))

Typical thermal resistance (Θ<sub>Jc</sub>) = 51.4 °C/W.

a) For T<sub>C</sub> = +25°C,

T<sub>J</sub> = 97°C @ 5 V, 300 mA, P<sub>OUT</sub> = 23 dBm, P<sub>IN</sub> = 3 dBm

b) For T<sub>C</sub> = +85°C,

T<sub>J</sub> = 154 °C @ 5V, 285 mA, P<sub>OUT</sub> = 22.3 dBm, P<sub>IN</sub> = 3 dBm

c) For T<sub>C</sub> = +125°C,

T<sub>J</sub> = 191 °C @ 5V, 270 mA, P<sub>OUT</sub> = 21.3 dBm, P<sub>IN</sub> = 3 dBm

9. Operating temperature is defined at the back of device paddle.

10. MTTF may be less than 1 x 10<sup>6</sup> hours.

### Handling Procedures

Please observe the following precautions to avoid damage:

### Static Sensitivity

These electronic devices are sensitive to electrostatic discharge (ESD) and can be damaged by static electricity. Proper ESD control techniques should be used when handling these devices.

PCB Layout

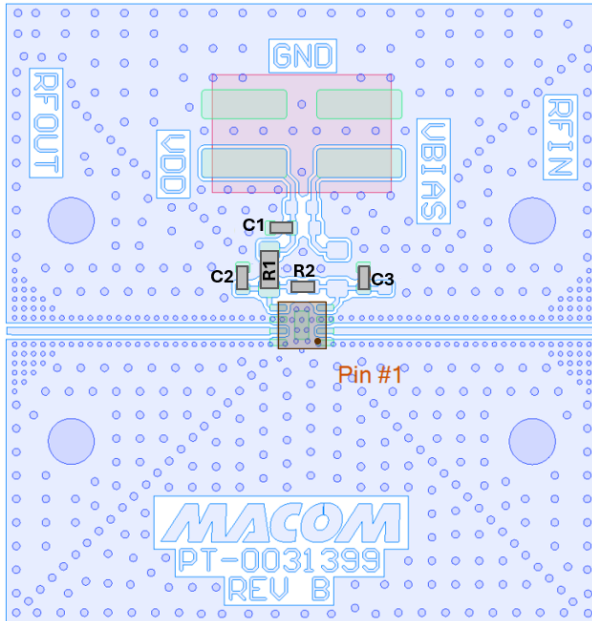

Parts List

Part	Value	Case Style
C1	0.1 $\mu$ F	0402
C2, C3	0.01 $\mu$ F	0402
R1	1.6 $\Omega$	0603
R2	910 $\Omega$	0402

Application Schematic

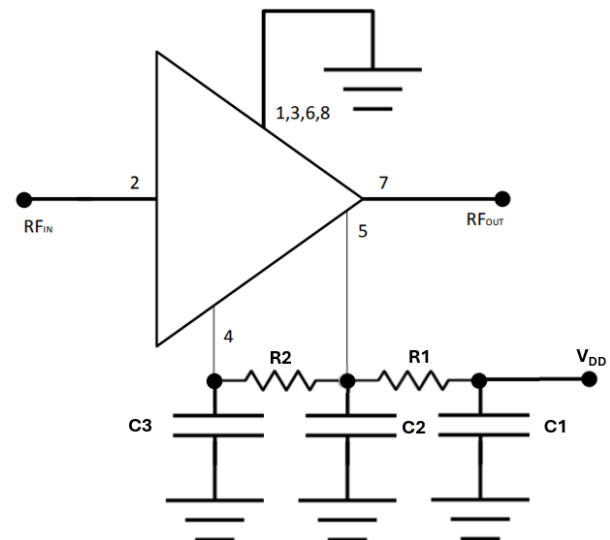

Board Loss

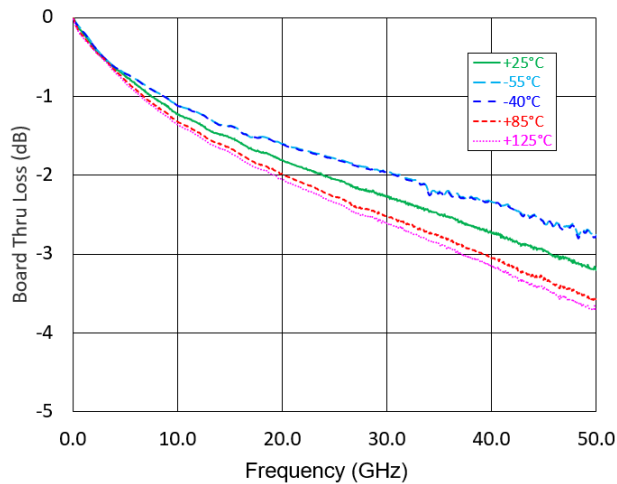

### Typical Performance Curves

**Gain**

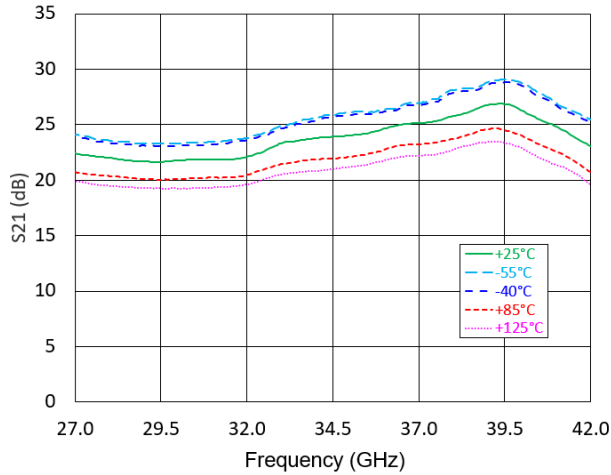

**Reverse Isolation**

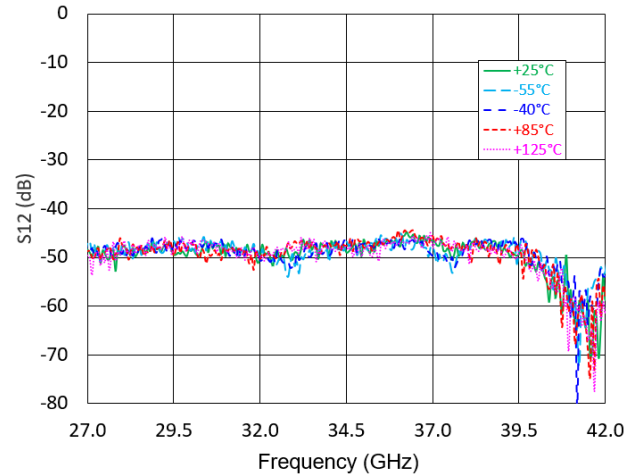

**Input Return Loss**

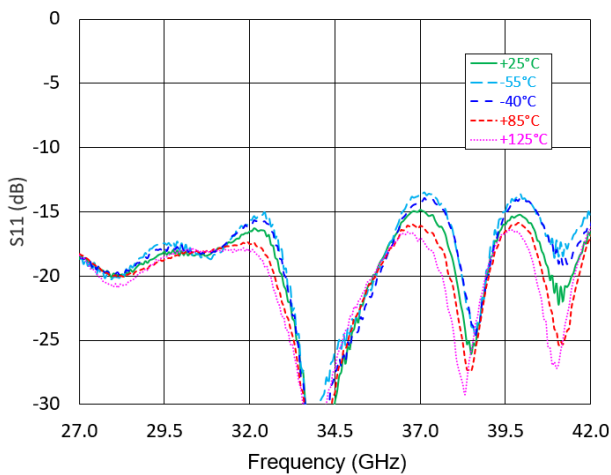

**Output Return Loss**

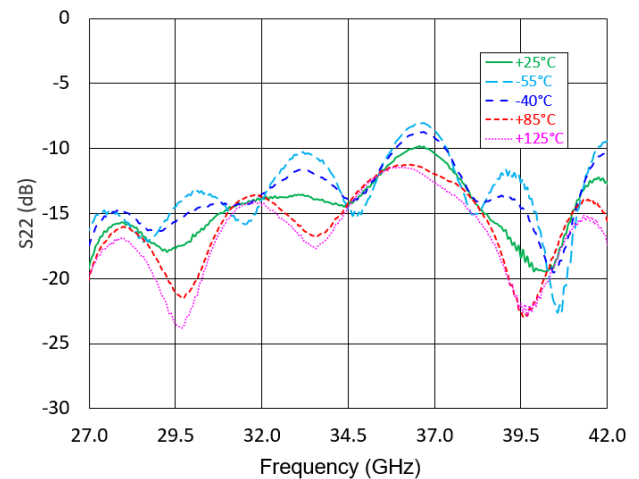

**Noise Figure**

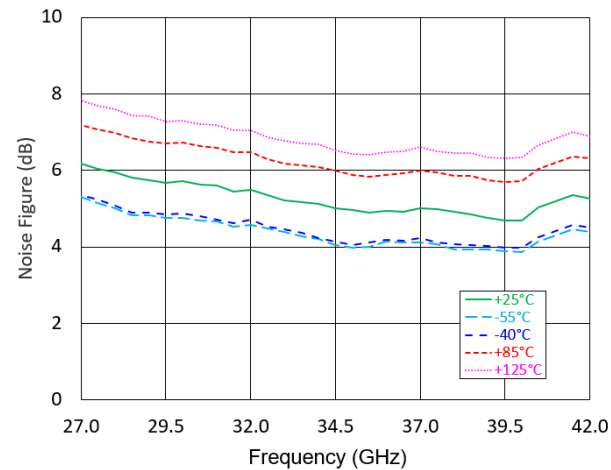

**Phase Noise**

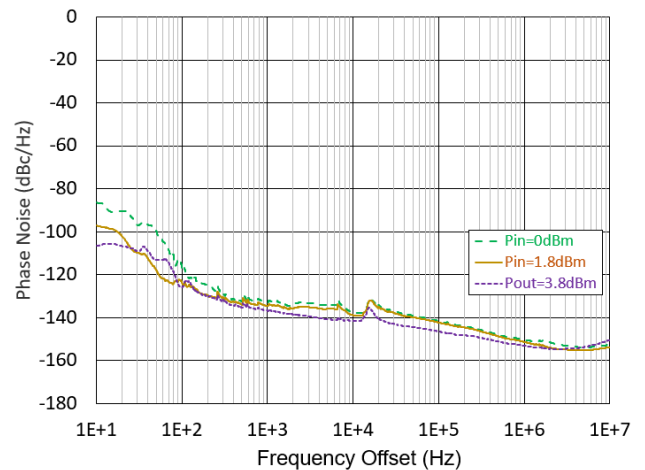

### Typical Performance Curves

**P1dB**

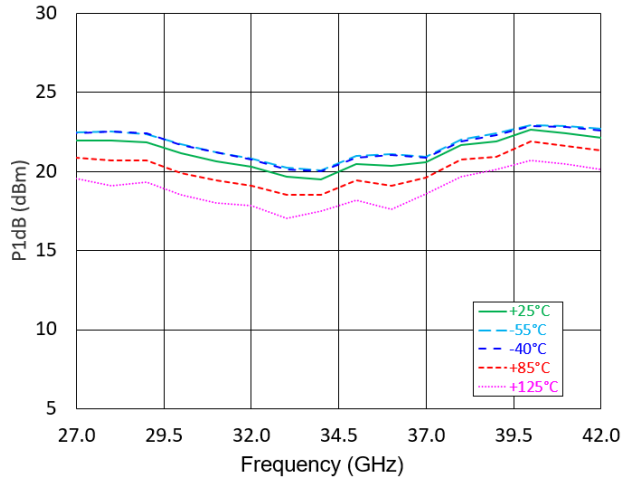

**P3dB**

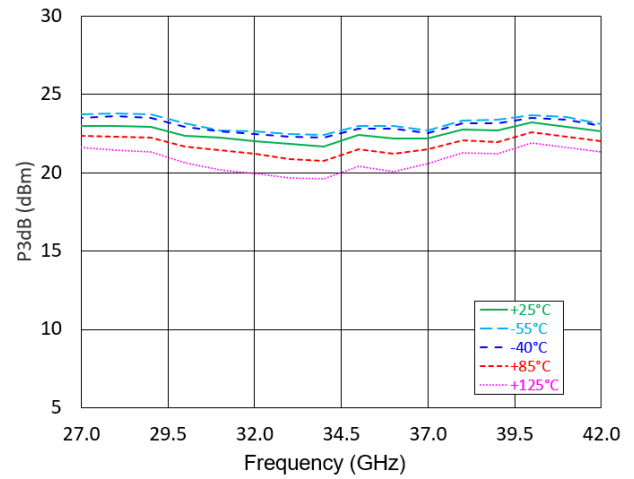

**Output Power vs. Frequency @  $P_{IN} = 3$  dBm**

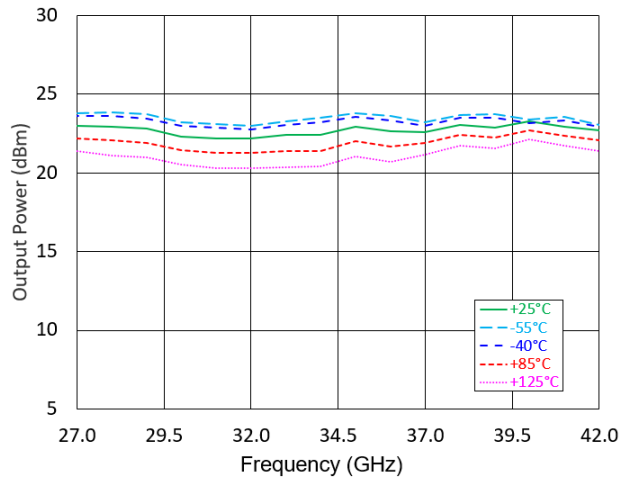

**Output Power vs. Frequency @  $P_{IN} = 2$  dBm**

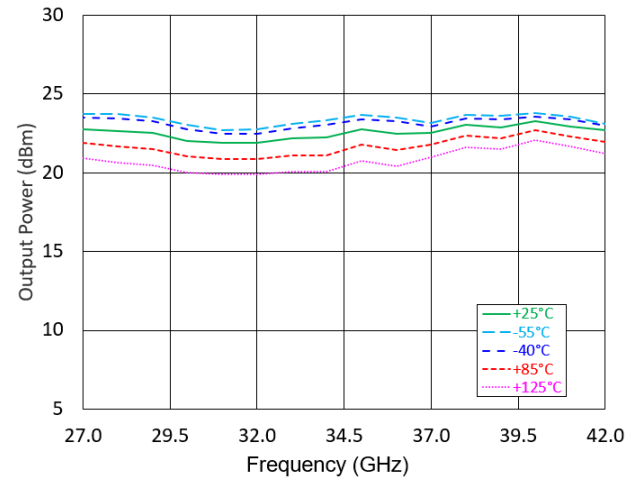

**Output Power vs. Frequency @  $P_{IN} = 1$  dBm**

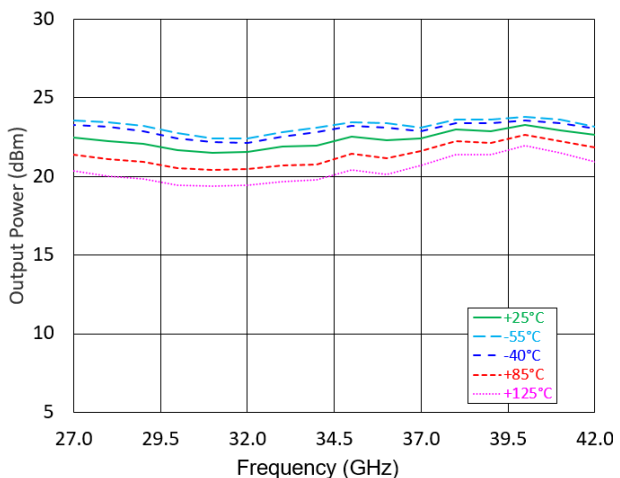

**Output Power over Input Power @ 25C**

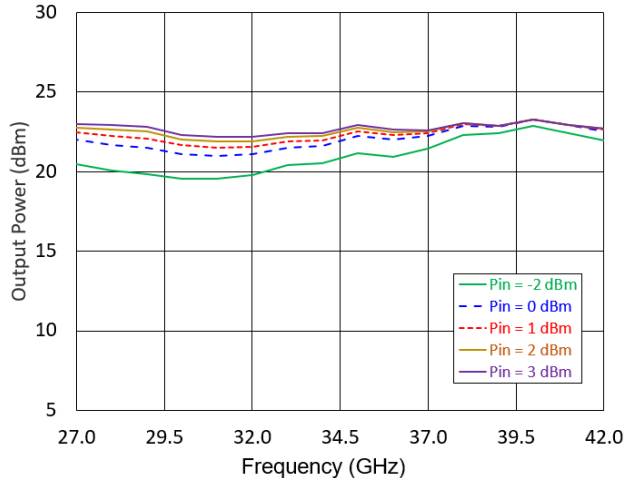

### Typical Performance Curves

**Output Power vs. Input Power @ 27 GHz**

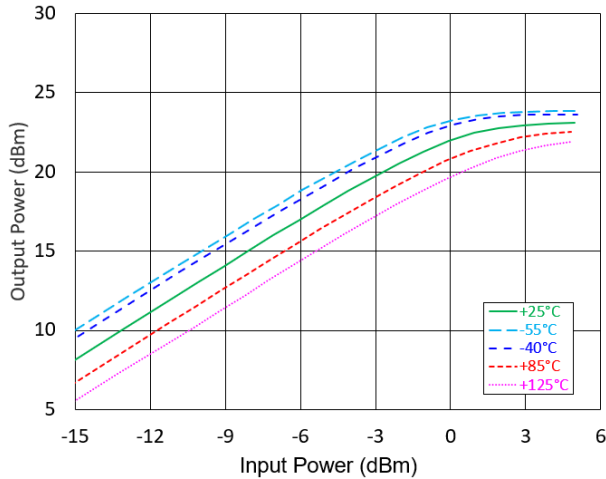

**Output Power vs. Input Power @ 35 GHz**

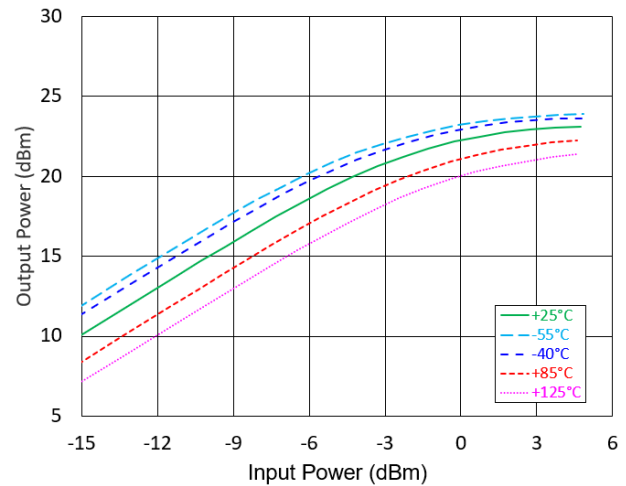

**Output Power vs. Input Power @ 42 GHz**

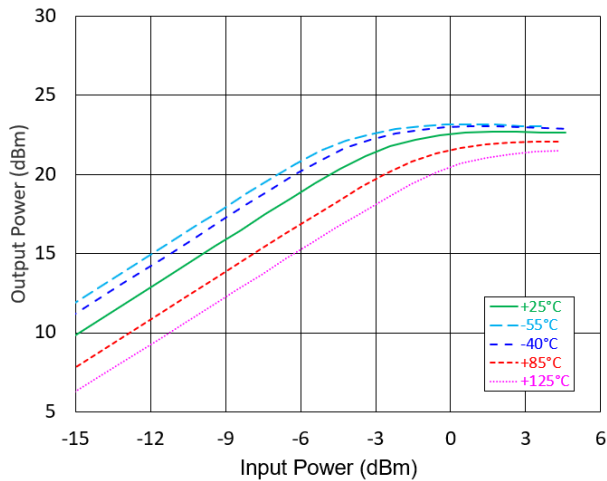

**OIP3 ( $P_{IN} = -22$  dBm / Tone)**

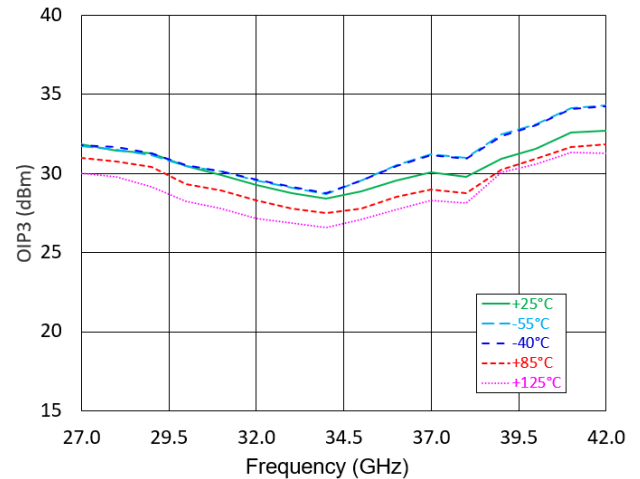



Lead-Free 2 mm, 8-Lead PDFN Package<sup>†</sup>

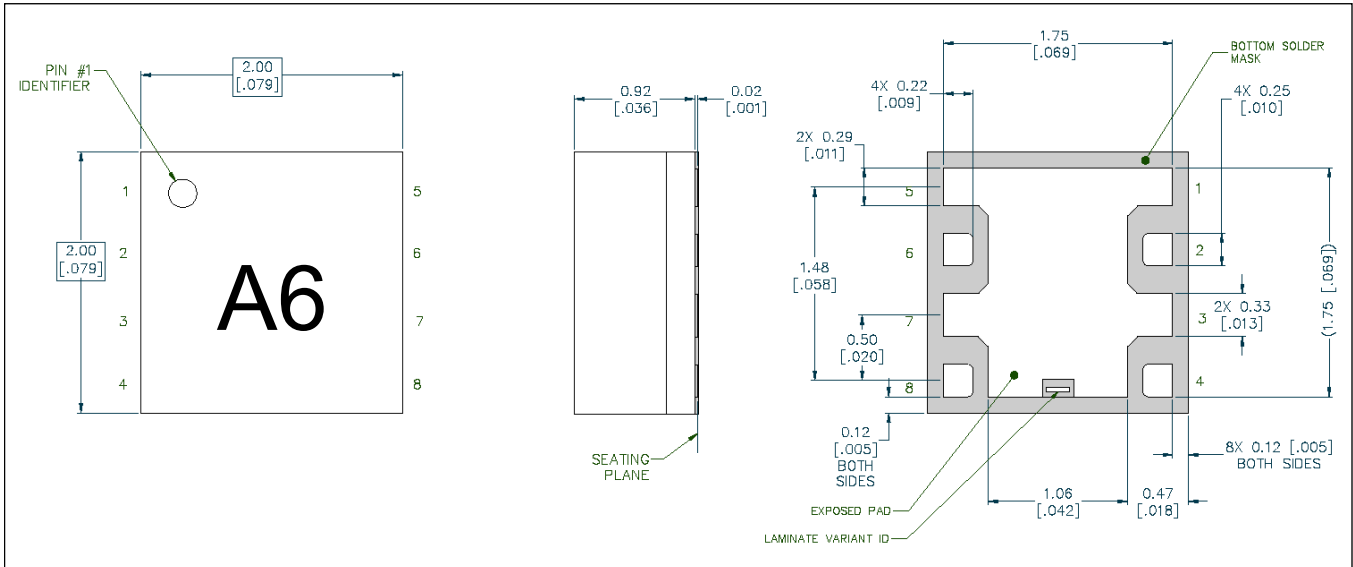

<sup>†</sup> Reference Application Note S2083 for lead-free solder reflow recommendations.  
Meets JEDEC moisture sensitivity level 1 requirements.  
Plating is 100% matte tin over copper.

Revision History

Rev	Date	Change Description
V1	3/27/22	Initial Release

MACOM Technology Solutions Inc. ("MACOM"). All rights reserved.

These materials are provided in connection with MACOM's products as a service to its customers and may be used for informational purposes only. Except as provided in its Terms and Conditions of Sale or any separate agreement, MACOM assumes no liability or responsibility whatsoever, including for (i) errors or omissions in these materials; (ii) failure to update these materials; or (iii) conflicts or incompatibilities arising from future changes to specifications and product descriptions, which MACOM may make at any time, without notice. These materials grant no license, express or implied, to any intellectual property rights.

THESE MATERIALS ARE PROVIDED "AS IS" WITH NO WARRANTY OR LIABILITY, EXPRESS OR IMPLIED, RELATING TO SALE AND/OR USE OF MACOM PRODUCTS INCLUDING FITNESS FOR A PARTICULAR PURPOSE, MERCHANTABILITY, INFRINGEMENT OF INTELLECTUAL PROPERTY RIGHT, ACCURACY OR COMPLETENESS, OR SPECIAL, INDIRECT, INCIDENTAL, OR CONSEQUENTIAL DAMAGES WHICH MAY RESULT FROM USE OF THESE MATERIALS.

MACOM products are not intended for use in medical, lifesaving or life sustaining applications. MACOM customers using or selling MACOM products for use in such applications do so at their own risk and agree to fully indemnify MACOM for any damages resulting from such improper use or sale.