

3T Low Noise Low Input Impedance Pre-Amplifier 127.74 MHz



MAAL-011228
Rev. V1

Features

- Non-Magnetic Laminate Module
- Noise Figure: 0.5 dB
- Gain: 27.1 dB
- Input Impedance (Real): 2.7Ω
- Output Impedance: 50Ω
- Single Voltage Bias: 3 V
- Integrated Active Bias Circuit
- RoHS* Compliant

Applications

- MRI Applications

Description

The MAAL-011228 is a high dynamic range, single stage MMIC LNA. The module includes external matching networks to provide excellent low noise performance and high gain characteristics suitable for 3.0T MRI applications.

This low noise amplifier has an integrated active bias circuit allowing direct connection to a 3 V bias and minimizing variations over temperature and process.

Functional Block Diagram

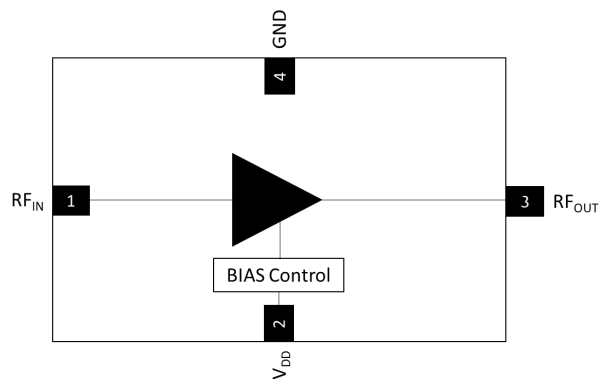

Pin Names^{2,3}

Pin #	Pin Name	Description
1	RF _{IN}	RF Input, DC Blocked
2	V _{DD}	Bias Voltage
3	RF _{OUT}	RF Output, DC Blocked
4	GND	Ground

2. MACOM recommends connecting unused package pins to ground.
3. The exposed pad centered on the package bottom must be connected to RF, DC and thermal ground.

Ordering Information¹

Part Number	Package
MAAL-011228-TR0100	100 piece reel
MAAL-011228-TR0500	500 piece reel
MAAL-011228-SMB	Sample Board

1. Reference Application Note M513 for reel size information.

* Restrictions on Hazardous Substances, compliant to current RoHS EU directive.

3T Low Noise Low Input Impedance Pre-Amplifier 127.74 MHz



MAAL-011228
Rev. V1

Electrical Specifications: Freq. = 127.74 MHz, T_A = 25°C, V_{DD} = +3 V, Z₀ = 50 Ω

3.0T (F _o = 127.74 MHz)					
Parameter	Test Conditions	Units	Min.	Typ.	Max.
Bandwidth	Centered at 127.74 MHz	MHz	—	1	—
Noise Figure	—	dB	—	0.5	—
Gain	—	dB	24.0	27.1	—
Input Reflection Coefficient	—	—	—	0.923	—
Real Input Impedance	—	Ω	—	2.7	—
Imaginary Input Impedance ⁴	—	Ω	-2.0	0	2.0
Output Return Loss	—	dB	—	18	—
Reverse Isolation	—	dB	—	57	—
Output IP3	P _{IN} = -22 dBm per tone, 100 kHz spacing	dBm	—	21	—
Output P1dB	—	dBm	—	8.5	—
Output P0.1 dB	—	dBm	—	5	—
Total Current	I _{DD} (I _{DS} +I _{BIAS})	mA	—	27	42

4. With test fixture at 27.6 mm “Delay Dist.” of RF input port and 1 Velocity Factor Port Extensions added.

Maximum Operating Limits^{5,6}

Parameter	Maximum
RF Input Power CW	-10 dBm
V _{DD}	5.5 V
Operating Temperature	-40°C to +85°C
Junction Temperature ^{6,7}	+150°C

5. Operating at nominal conditions with T_J ≤ 150°C will ensure MTTF > 1 x 10⁶ hours.

6. Junction Temperature (T_J) = T_C + Θ_{JC} * ((V * I) - (P_{OUT} - P_{IN}))

Typical thermal resistance (Θ_{JC}) = 83°C/W

a) For T_C = +25°C,

T_J = 33°C @ 3V, 50 mA, P_{OUT} = 11 dBm

b) For T_C = +85°C,

T_J = 93°C @ 3V, 50 mA, P_{OUT} = 11 dBm

Absolute Maximum Ratings^{7,8}

Parameter	Absolute Maximum
RF Input Power CW	19 dBm
V _{DD}	6.0 V
Storage Temperature	-55°C to +150°C

7. Exceeding any one or combination of these limits may cause permanent damage to this device.

8. MACOM does not recommend sustained operation near these survivability limits.

PCB Layout

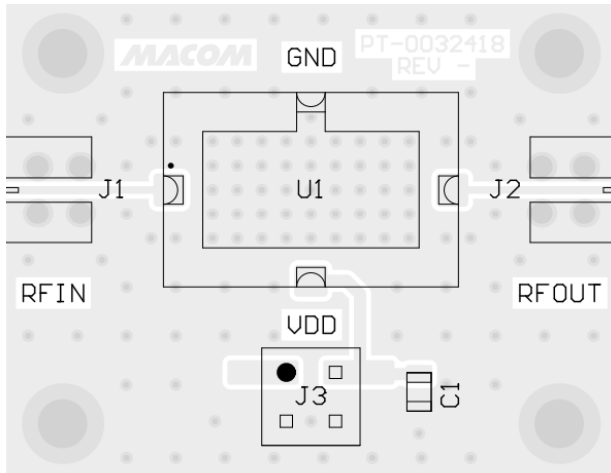

Parts List

Part	Value	Case Style
C1	1 μ F	0805

Handling Procedures

Please observe the following precautions to avoid damage:

Static Sensitivity

These electronic devices are sensitive to electrostatic discharge (ESD) and can be damaged by static electricity. Proper ESD control techniques should be used when handling these Class 2 HBM and Class C2A CDM devices.

Typical Performance Curves

Gain

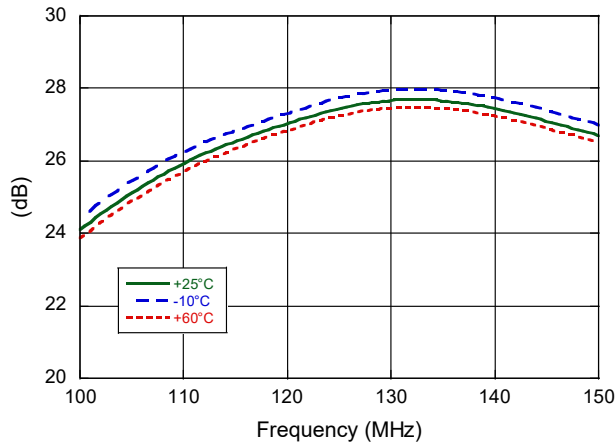

Real Zin

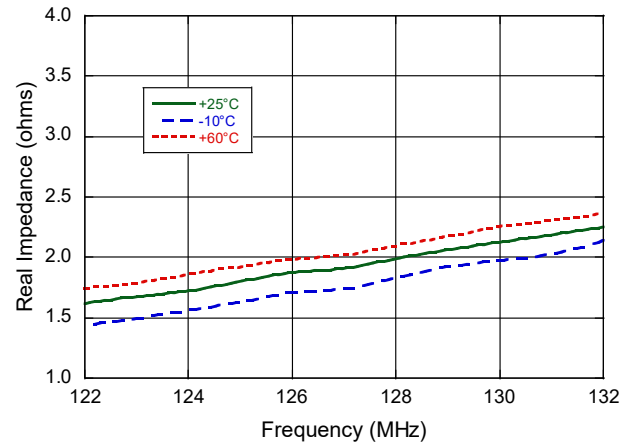

Output Return Loss

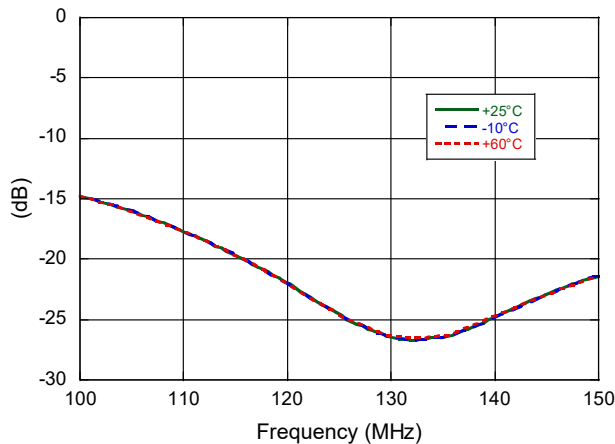

Imaginary Zin

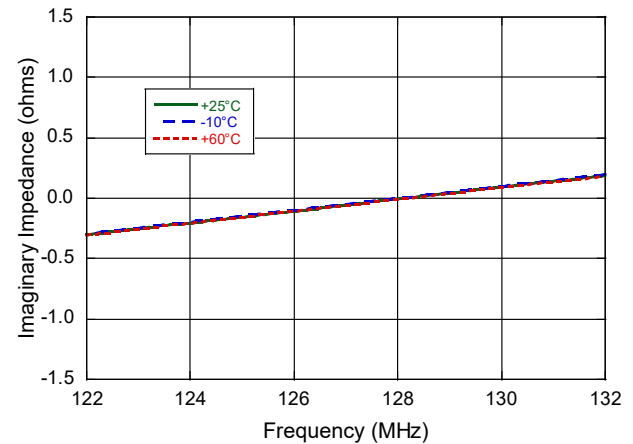

Reverse Isolation

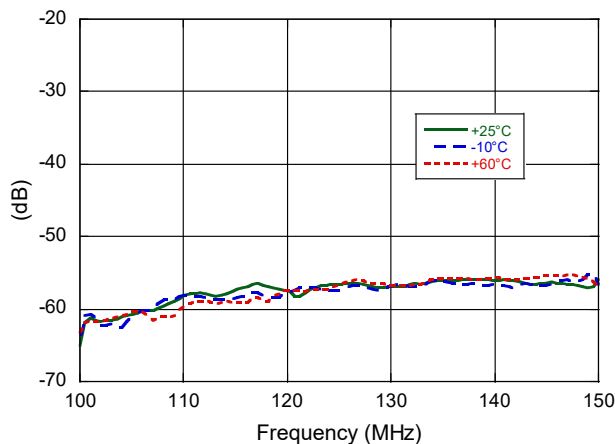

Noise Figure

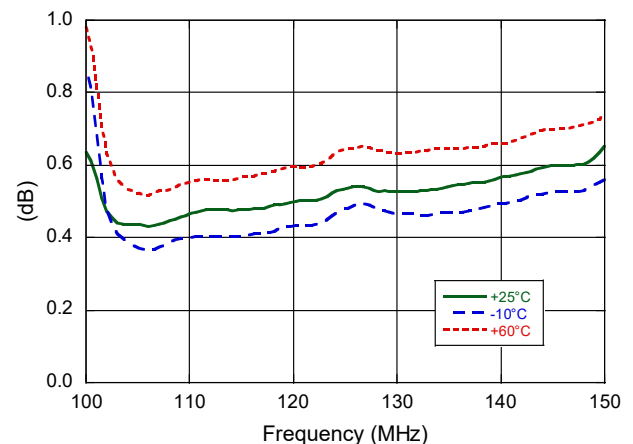

3T Low Noise Low Input Impedance Pre-Amplifier 127.74 MHz



MAAL-011228
Rev. V1

Lead-Free Laminate Package

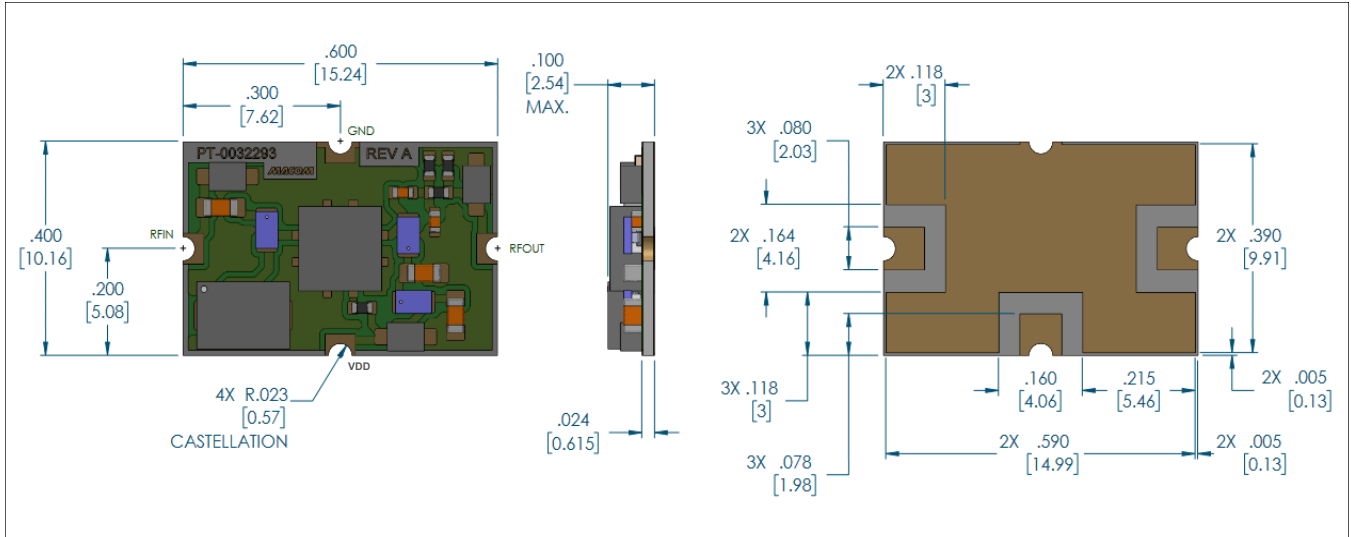

3T Low Noise Low Input Impedance Pre-Amplifier 127.74 MHz



MAAL-011228
Rev. V1

MACOM Technology Solutions Inc. ("MACOM"). All rights reserved.

These materials are provided in connection with MACOM's products as a service to its customers and may be used for informational purposes only. Except as provided in its Terms and Conditions of Sale or any separate agreement, MACOM assumes no liability or responsibility whatsoever, including for (i) errors or omissions in these materials; (ii) failure to update these materials; or (iii) conflicts or incompatibilities arising from future changes to specifications and product descriptions, which MACOM may make at any time, without notice. These materials grant no license, express or implied, to any intellectual property rights.

THESE MATERIALS ARE PROVIDED "AS IS" WITH NO WARRANTY OR LIABILITY, EXPRESS OR IMPLIED, RELATING TO SALE AND/OR USE OF MACOM PRODUCTS INCLUDING FITNESS FOR A PARTICULAR PURPOSE, MERCHANTABILITY, INFRINGEMENT OF INTELLECTUAL PROPERTY RIGHT, ACCURACY OR COMPLETENESS, OR SPECIAL, INDIRECT, INCIDENTAL, OR CONSEQUENTIAL DAMAGES WHICH MAY RESULT FROM USE OF THESE MATERIALS.

MACOM products are not intended for use in medical, lifesaving or life sustaining applications. MACOM customers using or selling MACOM products for use in such applications do so at their own risk and agree to fully indemnify MACOM for any damages resulting from such improper use or sale.