

# Distributed Low Noise Amplifier

## 2 - 20 GHz



MAAL-011182

Rev. V2

### Features

- Gain: 15 dB @ 14 GHz
- Noise Figure: 1.5 dB @ 14 GHz
- Output P1dB: 14 dBm @ 14 GHz
- Output P3dB: 17 dBm @ 14 GHz
- Output IP3: 24 dBm @ 14 GHz
- Single Positive Supply: 5 V
- 5 mm, 32 lead PQFN Package
- RoHS\* Compliant

### Applications

- EW, Radar
- Test & Measurement

### Description

The MAAL-011182 is a wideband distributed low noise amplifier with an operating frequency range of 2 to 20 GHz. This LNA has a 1.5 dB typical noise figure @ 14 GHz, 15 dB typical gain, and a 24 dBm typical output IP3. The output P1dB is 14 dBm typical with a 16 dBm typical P3dB. Only a single positive bias supply voltage of 5 V is required to bias the LNA. The typical current draw is 65 mA.

No external matching components are required. There are internal DC blocking capacitors at the input and output pins.

The MAAL-011182 is designed for wideband low noise applications such as test equipment. The 5 mm, 32 lead PQFN package is lead free and RoHS compliant.

This product is also available as a bare DIE under part number MAAL-011182-DIE.

### Block Diagram

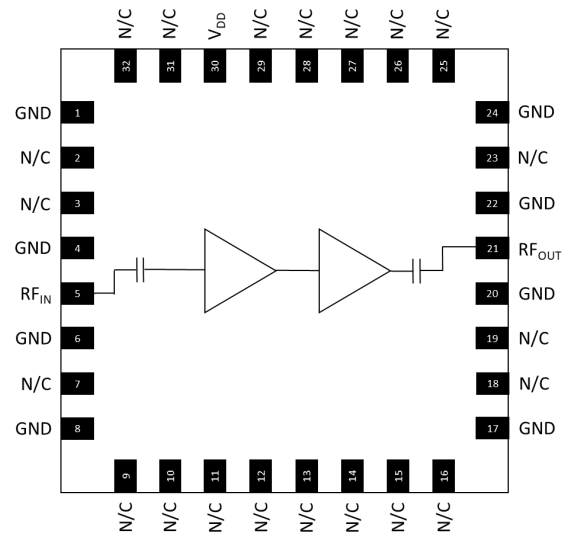

### Pin Configuration<sup>1,2</sup>

Pin #	Pin Name	Description
2,3,7,9-16,18,19,23,25-29,31,32	N/C	No Connection
1,4,6,8,17,20,22,24	GND	Ground
5	RF <sub>IN</sub>	RF Input
21	RF <sub>OUT</sub>	RF Output
30	V <sub>DD</sub>	Bias Voltage

1. It is recommended that all NC (No Connect) pins be grounded.
2. The exposed pad centered on the package bottom must be connected to RF, DC, and thermal ground.

### Ordering Information

Part Number	Package
MAAL-011182-TR0500	500 piece reel
MAAL-011182-SMB	Sample Board

\* Restrictions on Hazardous Substances, compliant to current RoHS EU directive.

# Distributed Low Noise Amplifier

## 2 - 20 GHz



MAAL-011182

Rev. V2

**Electrical Specifications:  $V_{DD} = +5\text{ V}$ ,  $I_{DD} = 65\text{ mA}$ ,  $T_A = 25^\circ\text{C}$ ,  $Z_0 = 50\ \Omega$**

Parameter	Test Conditions	Units	Min.	Typ.	Max.
Gain	2 - 6 GHz 6 - 14 GHz 14 - 20 GHz	dB	12.5 13.0 13.0	14.5 15.0 16.0	—
Gain Flatness	2 - 6 GHz 6 - 14 GHz 14 - 20 GHz	dB	—	+/-0.5 +/-0.5 +/-0.5	—
Gain Variation vs. Temperature	10 GHz	dB/°C	—	0.02	—
Noise Figure	2 - 6 GHz 6 - 14 GHz 14 - 20 GHz	dB	—	4.0 1.5 3.0	4.5 2.5 4.0
Input Return Loss	2 - 20 GHz	dB	—	13	—
Output Return Loss	2 - 20 GHz	dB	—	12	—
Output P1dB	2 - 6 GHz 6 - 14 GHz 14 - 20 GHz	dBm	—	15 14 12	—
Output P3dB	2 - 6 GHz 6 - 14 GHz 14 - 20 GHz	dBm	—	17 16 15	—
OIP3	2 - 6 GHz 6 - 14 GHz 14 - 20 GHz	dBm	19.0 19.5 18.0	24 24 22	—

### Maximum Operating Conditions

Parameter	Maximum
TX Input Power	9 dBm
Junction Temperature <sup>3,4</sup>	+160°C
Operating Temperature	-40°C to +85°C

3. Operating at nominal conditions with  $T_J \leq +160^\circ\text{C}$  will ensure MTTF >  $1 \times 10^6$  hours.

4. TX Junction Temp. ( $T_J$ ) =  $T_C + \Theta_{jc} * ((V * I) - (P_{OUT} - P_{IN}))$ .

Typical TX thermal resistance ( $\Theta_{jc}$ ) = 86.2°C/W.

a) For  $T_C = +85^\circ\text{C}$ ,  $T_J = 113^\circ\text{C}$  @ 5 V, 65 mA

b) For  $T_C = +25^\circ\text{C}$ ,  $T_J = 53^\circ\text{C}$  @ 5 V, 65 mA

### Absolute Maximum Ratings<sup>5,6</sup>

Parameter	Absolute Maximum
TX Input Power	25 dBm
Junction Temperature <sup>7</sup>	+180°C
Storage Temperature	-55°C to +150°C

5. Exceeding any one or combination of these limits may cause permanent damage to this device.

6. MACOM does not recommend sustained operation near these survivability limits.

7. Junction temperature directly effects device MTTF. Junction temperature should be kept as low as possible to maximize lifetime.

### Recommended PCB Layout

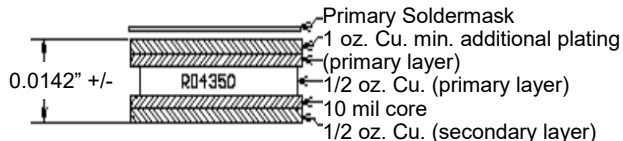
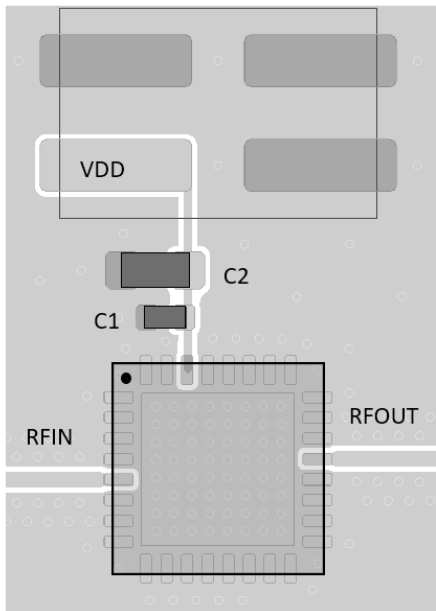

### Parts List

Part	Value	Case Style
C1	100 pF	0201
C2	1000 pF	0402

### Application Schematic

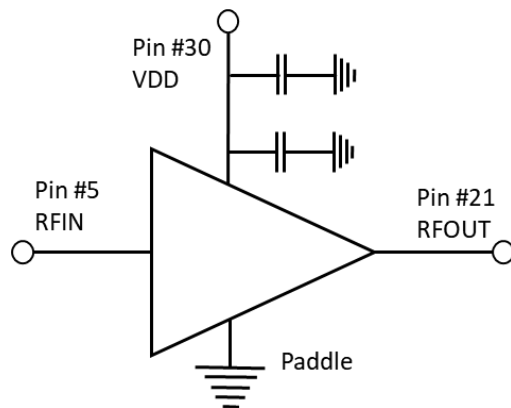

### Handling Procedures

Please observe the following precautions to avoid damage:

### Static Sensitivity

These electronic devices are sensitive to electrostatic discharge (ESD) and can be damaged by static electricity. Proper ESD control techniques should be used when handling these HBM class 1B devices.

# Distributed Low Noise Amplifier 2 - 20 GHz



MAAL-011182

Rev. V2

## Typical Performance Curves

**Gain**

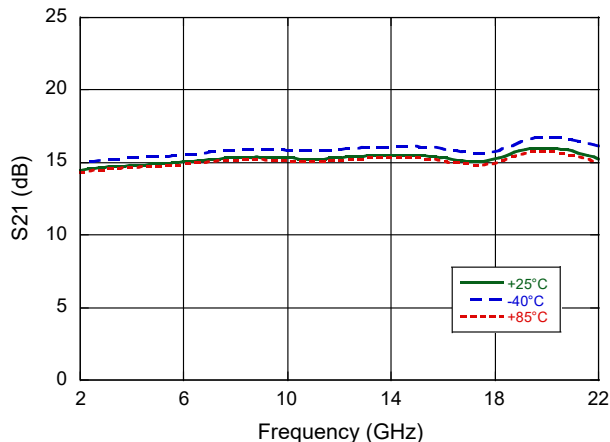

**Noise Figure**

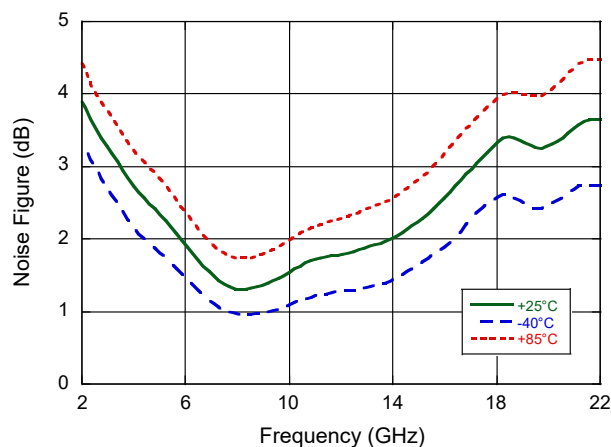

**Input Return Loss**

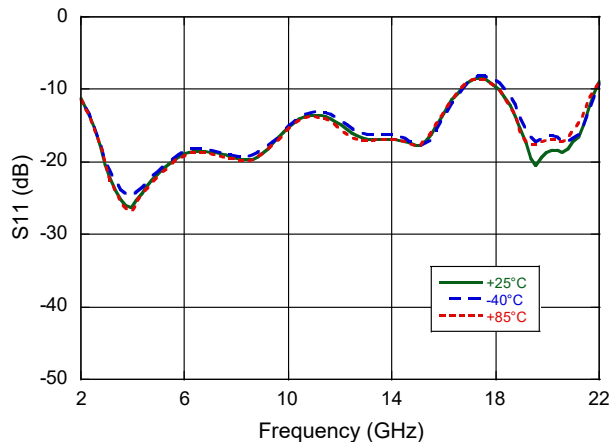

**Output Return Loss**

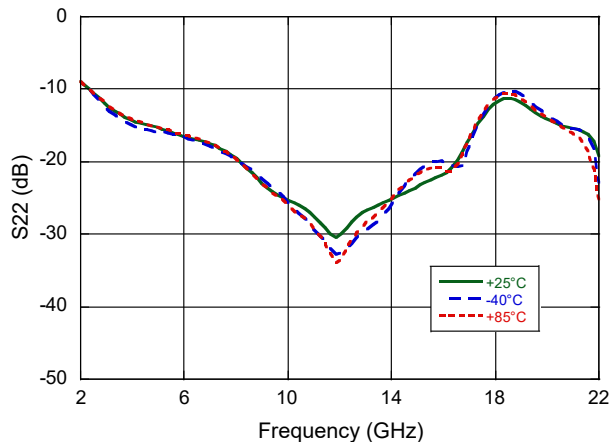

**Reverse Isolation**

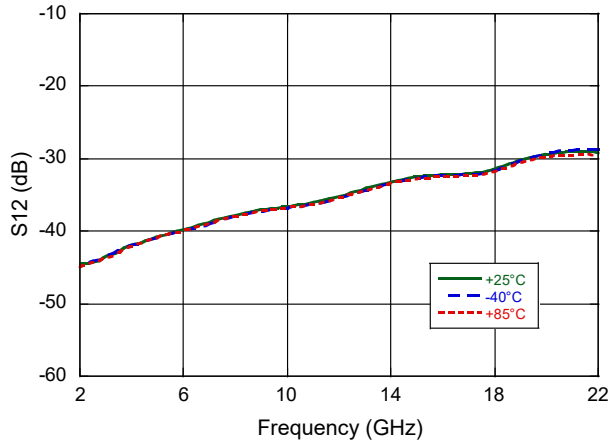

**PCB Loss (RF<sub>IN</sub> + RF<sub>OUT</sub>)**

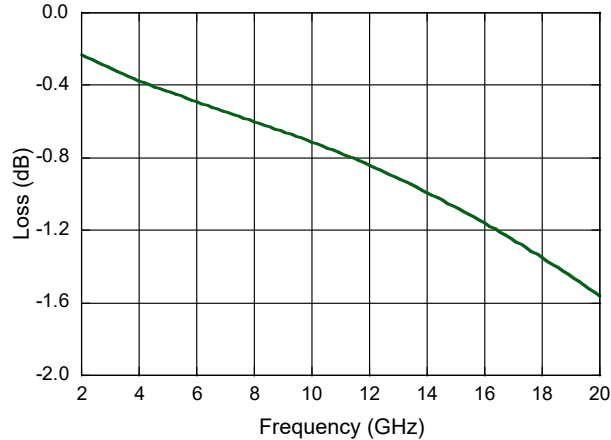

# Distributed Low Noise Amplifier

## 2 - 20 GHz



MAAL-011182

Rev. V2

### Typical Performance Curves

**P1dB**

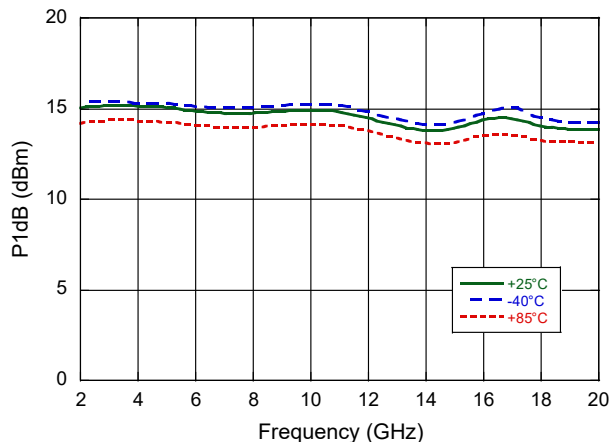

**OIP3**

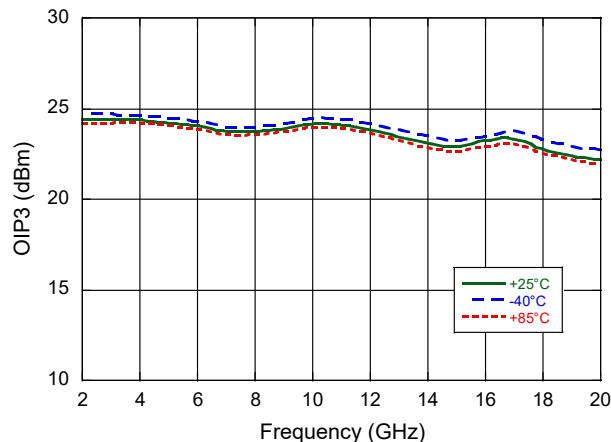

**P1dB vs. V<sub>DD</sub>**

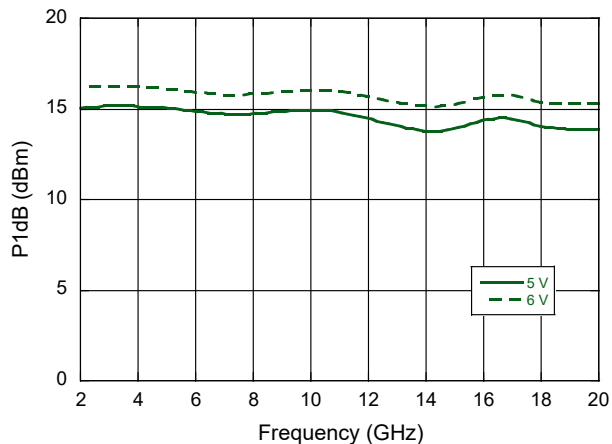

**OIP3 vs. V<sub>DD</sub>**

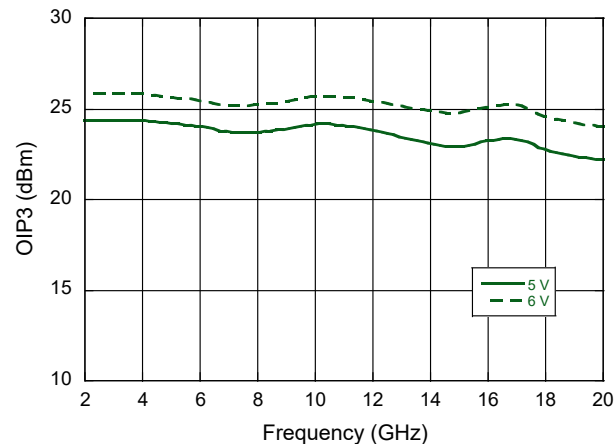

**P3dB vs. V<sub>DD</sub>**

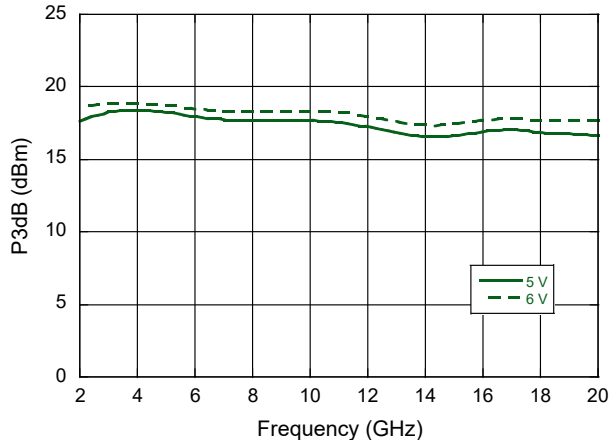



# Distributed Low Noise Amplifier

## 2 - 20 GHz



MAAL-011182

Rev. V2

MACOM Technology Solutions Inc. ("MACOM"). All rights reserved.

These materials are provided in connection with MACOM's products as a service to its customers and may be used for informational purposes only. Except as provided in its Terms and Conditions of Sale or any separate agreement, MACOM assumes no liability or responsibility whatsoever, including for (i) errors or omissions in these materials; (ii) failure to update these materials; or (iii) conflicts or incompatibilities arising from future changes to specifications and product descriptions, which MACOM may make at any time, without notice. These materials grant no license, express or implied, to any intellectual property rights.

THESE MATERIALS ARE PROVIDED "AS IS" WITH NO WARRANTY OR LIABILITY, EXPRESS OR IMPLIED, RELATING TO SALE AND/OR USE OF MACOM PRODUCTS INCLUDING FITNESS FOR A PARTICULAR PURPOSE, MERCHANTABILITY, INFRINGEMENT OF INTELLECTUAL PROPERTY RIGHT, ACCURACY OR COMPLETENESS, OR SPECIAL, INDIRECT, INCIDENTAL, OR CONSEQUENTIAL DAMAGES WHICH MAY RESULT FROM USE OF THESE MATERIALS.

MACOM products are not intended for use in medical, lifesaving or life sustaining applications. MACOM customers using or selling MACOM products for use in such applications do so at their own risk and agree to fully indemnify MACOM for any damages resulting from such improper use or sale.