

Features

- Low Noise Figure
- Excellent Input Return Loss
- Single Voltage Bias 4 V
- Integrated Active Bias Circuit
- Current Adjustable 20 - 80 mA with an External Resistor
- High Linearity, OIP3 >32 dBm
- 8-Lead Hermetic Package
- RoHS* Compliant

Description

The MAAL-010705-CR10 is a high dynamic range single stage MMIC LNA with excellent linearity and low noise figure designed for operation from 0.5 to 3 GHz. The LNA is packaged in an RoHS compliant, 8-lead hermetically sealed ceramic package.

This MMIC has an integrated active bias circuit allowing direct connection to 4 V voltage supply and minimizing variation over temperature and process. The bias current and gain can be set with external resistors to allow the user to customize the current and gain value to fit the application.

The MAAL-010705-CR10 offers less than 0.7 dB noise figure, more than 32 dBm OIP3 and 20 dB output return loss. The excellent match, low noise figure and high OIP3 along with the flexibility of setting current and gain make this LNA ideal UHF, L, and S-band satellite applications.

Ordering Information

Part Number	Package
MAAL-010705-CR10	Chip Scale Package

Functional Block Diagram

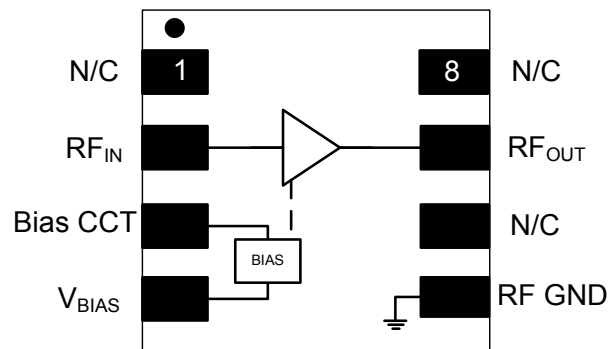

Pin Configuration¹

Pin No.	Pin Name	Description
1	N/C	No Connection
2	RF _{IN}	RF Input
3	Bias CCT	Bias Circuit Reference
4	V _{BIAS}	Bias Voltage
5	RF GND	RF Ground
6	N/C	No Connection
7	RF _{OUT}	RF Output
8	N/C	No Connection

1. The exposed pad centered on the package bottom must be connected to RF, DC and thermal ground.

* Restrictions on Hazardous Substances, European Union Directive 2011/65/EU.

Electrical Specifications²: Freq = 0.9 GHz, $V_D = 4$ V, 25°C, $Z_0 = 50 \Omega$

Parameter	Test Conditions	Units	Min.	Typ.	Max.
Gain	—	dB	18	21	—
Input Return Loss	—	dB	—	15	—
Output Return Loss	—	dB	—	27	—
Noise Figure	—	dB	—	0.7	—
Output IP3	$P_{OUT} = 5$ dBm, Tone Spacing = 1 MHz	dBm	—	33	—
Output P1dB	—	dBm	17.5	18.5	—
Total Current	$I_{DQ} = I_D + I_{BIAS}$	mA	—	60	70

2. V_D and V_{BIAS} are connected together to 4 V, $R3 = 150 \Omega$ and $R4 = 240 \Omega$; reference recommended schematic on page 5.

Absolute Maximum Ratings^{3,4}

Parameter	Absolute Max.
Voltage	5.5 V
Current	100 mA
RF Input Power	20 dBm
Storage Temperature	-55°C to +150°C
Operating Temperature	-40°C to +85°C
Junction Temperature ⁵	+150°C

3. Exceeding any one or combination of these limits may cause permanent damage to this device.
4. MACOM does not recommend sustained operation near these survivability limits.
5. Typical thermal resistance (Θ_{jc}) = 45°C/W.

Handling Procedures

Please observe the following precautions to avoid damage:

Static Sensitivity

These electronic devices are sensitive to electrostatic discharge (ESD) and can be damaged by static electricity. Proper ESD control techniques should be used when handling these devices.

Typical Performance Curves: 4 V (over temperature)

Gain

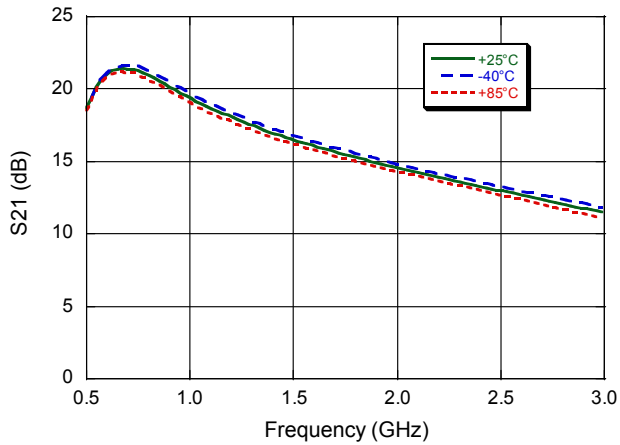

Reverse Isolation

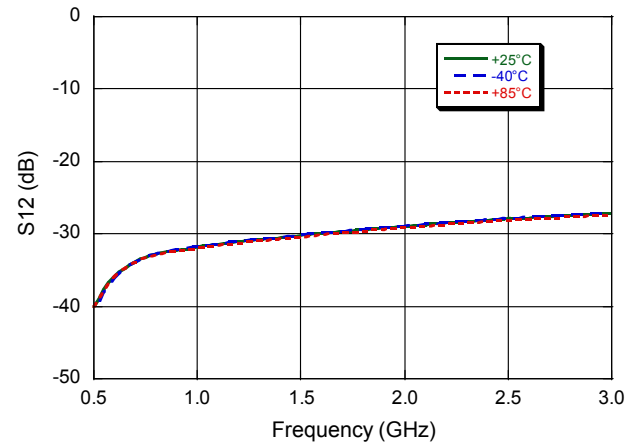

Input Return Loss

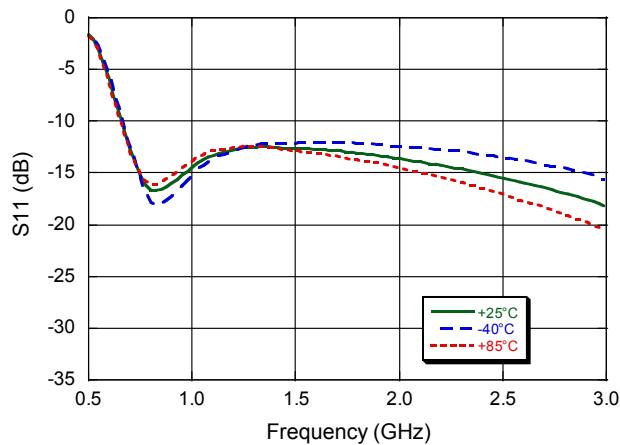

Output Return Loss

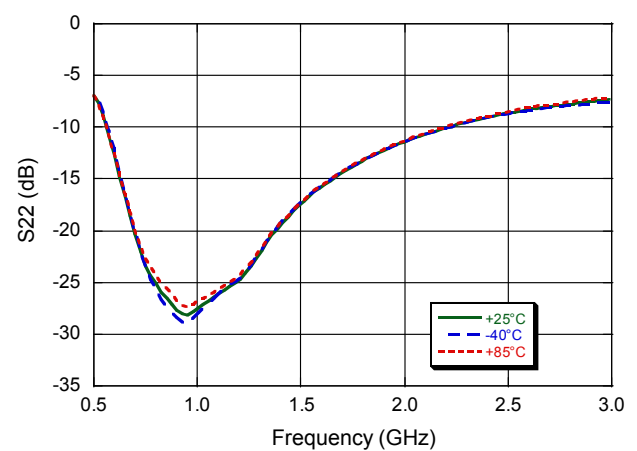

Noise Figure

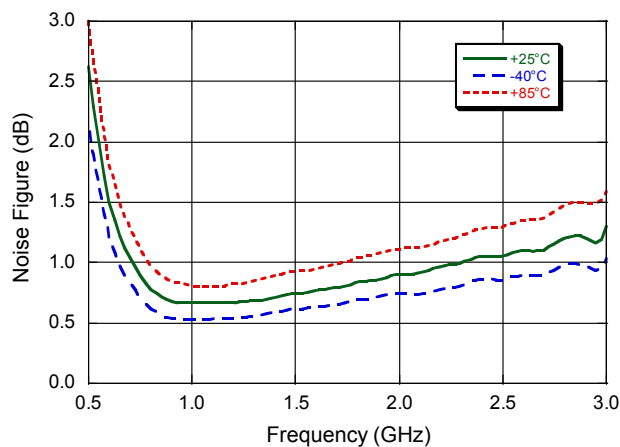

Typical Performance Curves @ 900 MHz, 4 V

OIP3 High vs. Output Power

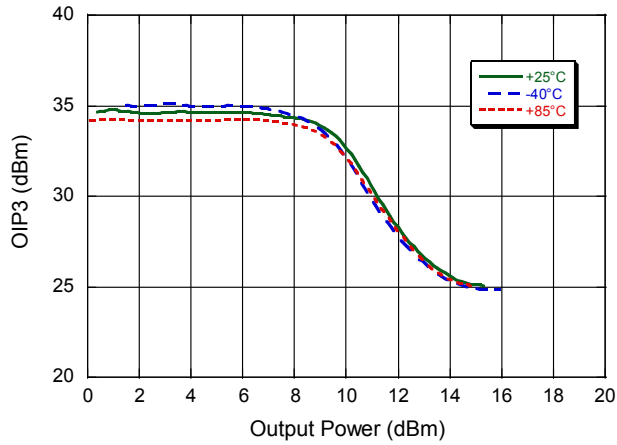

OIP3 Low vs. Output Power

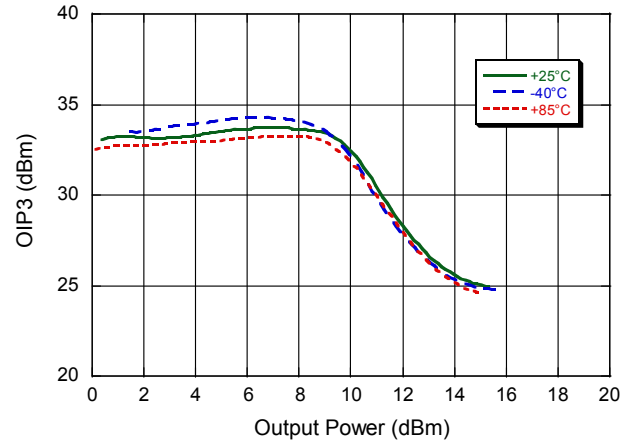

Gain vs. Output Power

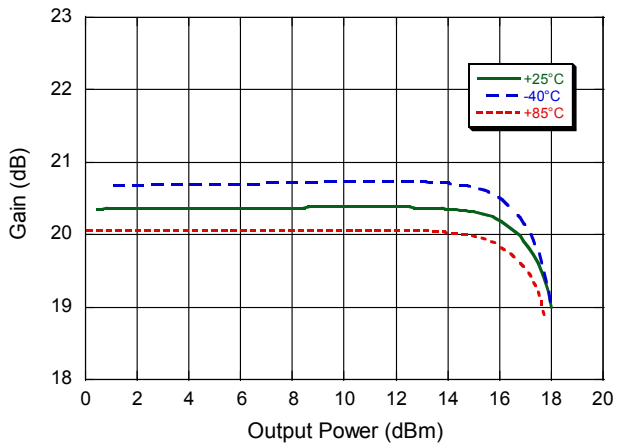

P1dB vs. Frequency

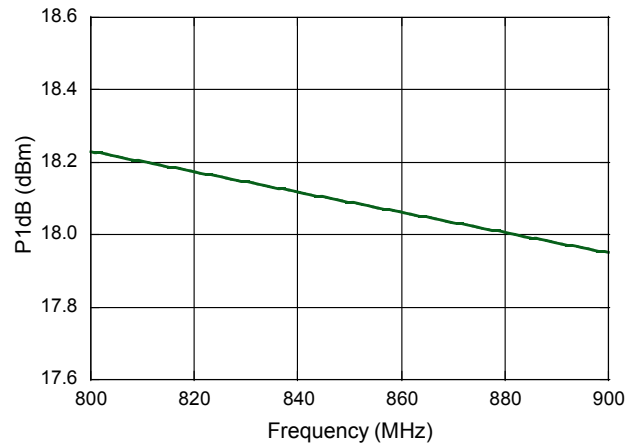

OIP3 vs. Frequency

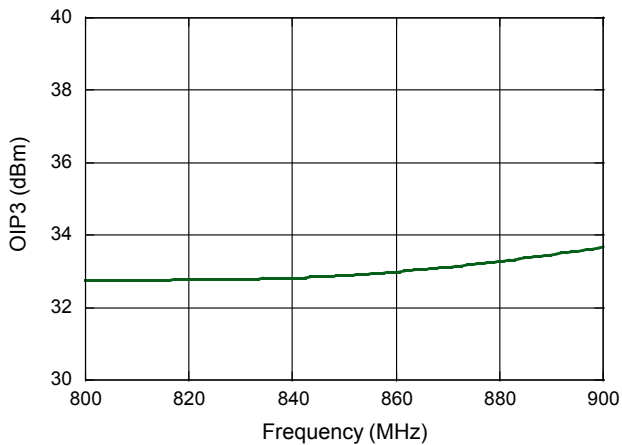

Recommended Layout

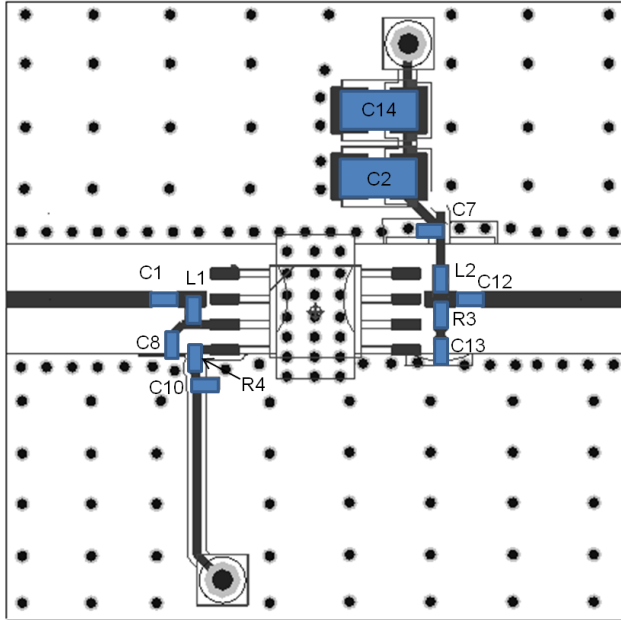

Off-Chip Component Values

Component	Value	Package
C1	3.3 pF	0402
C7, C8, C10	1000 pF	0402
C12, C13	100 pF	0402
C2, C14	4.7 μ F	Tantalum, 1210
L1	9 nH	0402
L2	15 nH	0402
R3	150 Ω	0402
R4	240 Ω	0402

Bias Information

V_{BIAS} and V_D are separate connections on the evaluation board to give the option of varying I_D without changing R4. They can be connected together to a single voltage supply during the measurement and in the final layout implementation of the PCB. If two different voltage supplies are used then apply V_D first and then V_{BIAS} to turn on the LNA. To turn off the LNA disconnect V_{BIAS} first and then V_D . R3 is varied to obtain different levels of gain. R4 is varied to change the drain current I_d .

Schematic

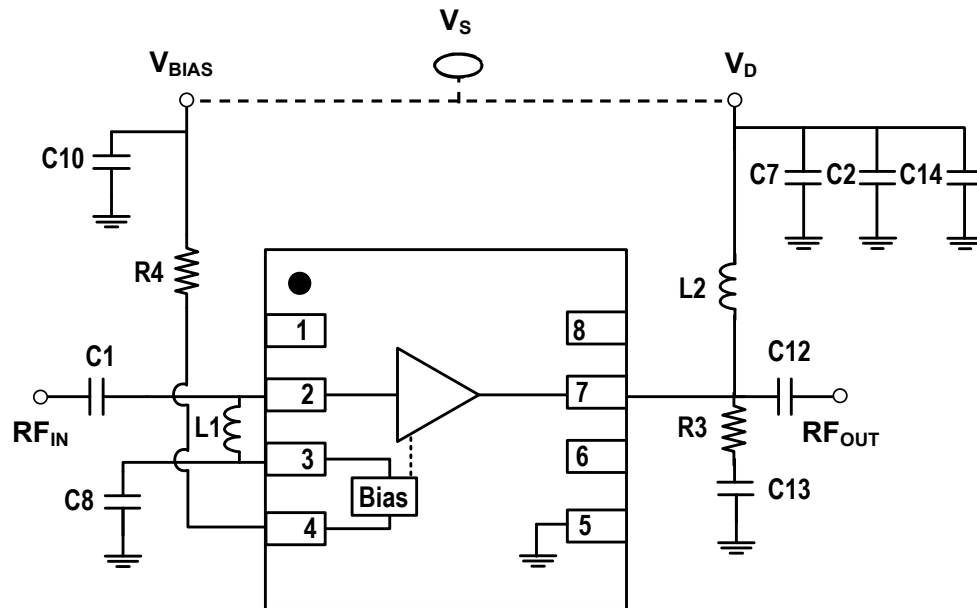

Lead-Free Hermetic CR10 Package[†]

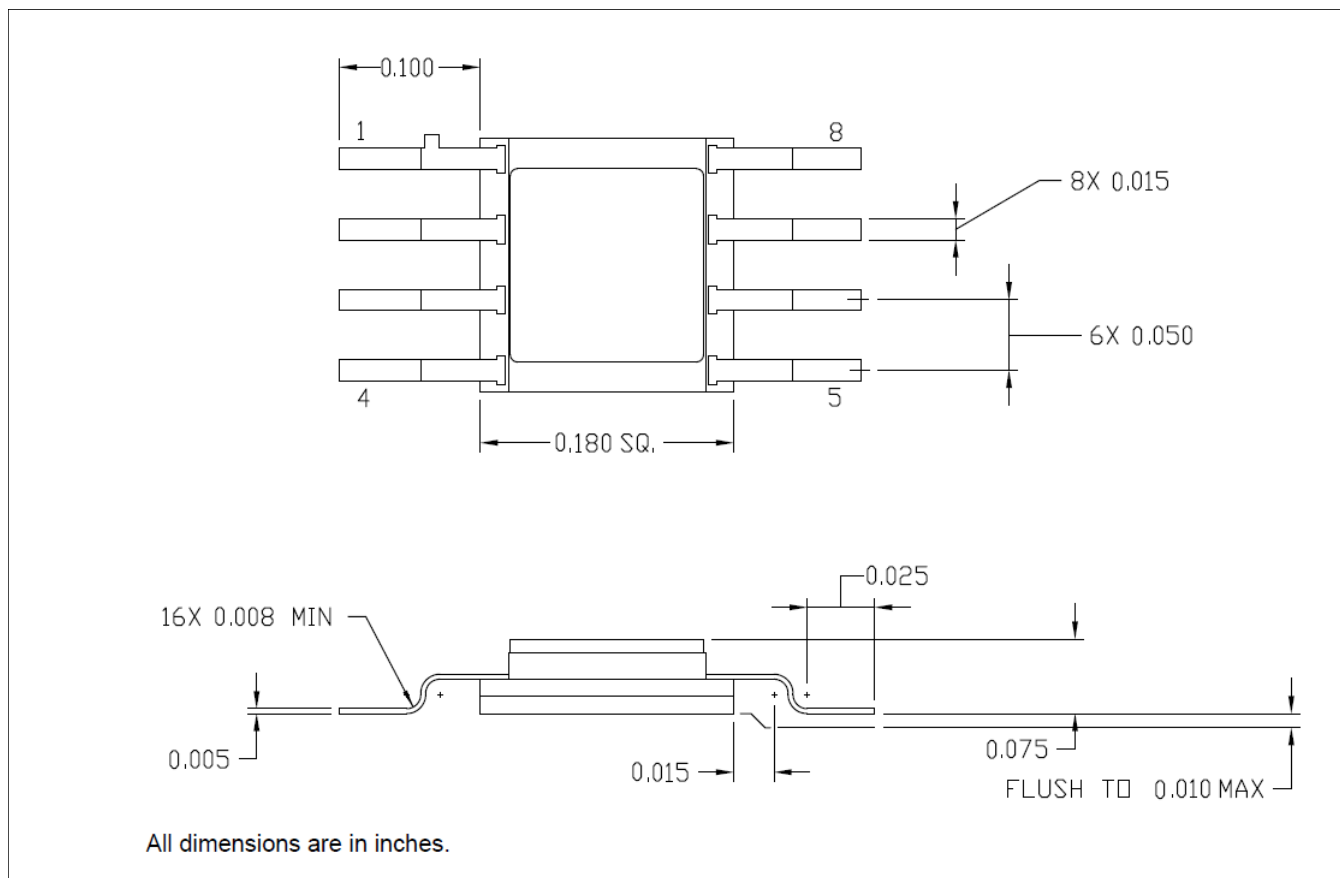

[†] Reference Application Note S2083 for lead-free solder reflow recommendations.
Meets JEDEC moisture sensitivity level 1 requirements.
Plating is Au over Ni.

MACOM Technology Solutions Inc. All rights reserved.

Information in this document is provided in connection with MACOM Technology Solutions Inc ("MACOM") products. These materials are provided by MACOM as a service to its customers and may be used for informational purposes only. Except as provided in MACOM's Terms and Conditions of Sale for such products or in any separate agreement related to this document, MACOM assumes no liability whatsoever. MACOM assumes no responsibility for errors or omissions in these materials. MACOM may make changes to specifications and product descriptions at any time, without notice. MACOM makes no commitment to update the information and shall have no responsibility whatsoever for conflicts or incompatibilities arising from future changes to its specifications and product descriptions. No license, express or implied, by estoppel or otherwise, to any intellectual property rights is granted by this document.

THESE MATERIALS ARE PROVIDED "AS IS" WITHOUT WARRANTY OF ANY KIND, EITHER EXPRESS OR IMPLIED, RELATING TO SALE AND/OR USE OF MACOM PRODUCTS INCLUDING LIABILITY OR WARRANTIES RELATING TO FITNESS FOR A PARTICULAR PURPOSE, CONSEQUENTIAL OR INCIDENTAL DAMAGES, MERCHANTABILITY, OR INFRINGEMENT OF ANY PATENT, COPYRIGHT OR OTHER INTELLECTUAL PROPERTY RIGHT. MACOM FURTHER DOES NOT WARRANT THE ACCURACY OR COMPLETENESS OF THE INFORMATION, TEXT, GRAPHICS OR OTHER ITEMS CONTAINED WITHIN THESE MATERIALS. MACOM SHALL NOT BE LIABLE FOR ANY SPECIAL, INDIRECT, INCIDENTAL, OR CONSEQUENTIAL DAMAGES, INCLUDING WITHOUT LIMITATION, LOST REVENUES OR LOST PROFITS, WHICH MAY RESULT FROM THE USE OF THESE MATERIALS.

MACOM products are not intended for use in medical, lifesaving or life sustaining applications. MACOM customers using or selling MACOM products for use in such applications do so at their own risk and agree to fully indemnify MACOM for any damages resulting from such improper use or sale.