

## Features

- Integrated e/d Logic on chip
- Positive Single Control
- Insertion Loss 1.9 dB @ 6 GHz
- IP3: 42 dBm typical @ 2 GHz
- 1 dB Attenuation Steps to 15 dB
- Lead-Free 3 mm 16-Lead PQFN Package
- Halogen-Free “Green” Mold Compound
- RoHS\* Compliant and 260°C Re-flow Compatible

## Description

The MAADSS0019 is a 4-bit, 1-dB step GaAs MMIC digital attenuator in a lead-free 3 mm 16 lead PQFN surface mount plastic package.

The MAADSS0019 is ideally suited for use where high accuracy, very low power consumption and low intermodulation products are required. Typical applications include radio, cellular, wireless LANs, GPS equipment and other gain / level control circuits.

The MADSS0019 is part of a digital attenuator family. This family includes 4, 5 and 6 bit attenuators with 0.5, 1 or 2 dB steps and up to 31.5 range.

## Ordering Information<sup>1,2</sup>

Part Number	Package
MAADSS0019TR	1000 piece reel
MAADSS0019SMB	Sample Board 2 - 6 GHz Tuning

1. Reference Application Note M513 for reel size information.
2. All sample boards include 5 loose parts.

## Functional Schematic<sup>3</sup>

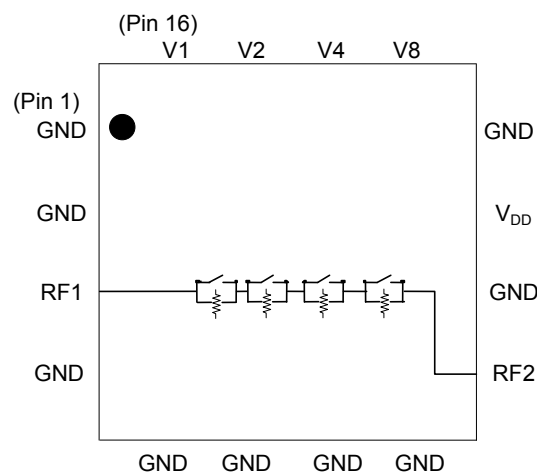

3. Blocking capacitors are required on all RF ports

## Pin Configuration

Pin No.	Function	Pin No.	Function
1	Ground	9	RF In/Out
2	Ground	10	Ground
3	RF In/Out	11	V <sub>DD</sub>
4	Ground	12	Ground
5	Ground	13	V8 (8 dB Bit)
6	Ground	14	V4 (4 dB Bit)
7	Ground	15	V2 (2 dB Bit)
8	Ground	16	V1 (1 dB Bit)
		17 <sup>4</sup>	Ground

4. The exposed pad centered on the package bottom must be connected to RF, DC and thermal ground.

\* Restrictions on Hazardous Substances, European Union Directive 2011/65/EU.

## Digital Attenuator, 15 dB, 4-Bit, Single Control 2 - 6 GHz

Rev. V3

Electrical Specifications<sup>5</sup>:  $T_A = +25^\circ\text{C}$ ,  $V_{DD} = 5\text{ V}$ ,  $Z_0 = 50\ \Omega$

Parameter	Test Conditions	Units	Min.	Typ.	Max.
Reference Insertion Loss	2.4 GHz 4.0 GHz 6.0 GHz	dB	—	1.3 1.8 1.9	1.8 3.0 3.0
Attenuation Accuracy	2.0 - 5.0 GHz 5.0 - 6.0 GHz	± (0.3 dB + 3% of attenuation setting in dB) dB ± (0.5 dB + 3% of attenuation setting in dB) dB			
VSWR	2.0 - 6.0 GHz	Ratio	—	1.4:1	—
$T_{RISE}$ , $T_{FALL}$	10% to 90% RF, 90% to 10% RF	ns	—	50	—
$T_{ON}$ , $T_{OFF}$	50% Control to 90% RF, 50% Control to 10% RF	ns	—	50	—
Transients	In Band	mV	—	75	—
1 dB Compression	Input Power, 2.0 GHz	dBm	—	25	—
IP2	2.0 - 6.0 GHz Measured Relative to Input (for two-tone Input Power up to +5 dBm)	dBm	—	80	—
IP3	2.0 - 6.0 GHz Measured Relative to Input (for two-tone Input Power up to +5 dBm)	dBm	—	42	—
$I_C$	$V_C = 5\text{ V}$	μA	—	15	25
$I_{DD}$	$V_{DD} = 5\text{ V}$	μA	—	170	300

5. External DC blocking capacitors are required on all RF ports. Loss varies at 0.003 dB/°C.

### Truth Table<sup>6</sup>

VC1	VC2	VC4	VC8	Attenuation (dB)
0	0	0	0	Reference IL
1	0	0	0	1
0	1	0	0	2
0	0	1	0	4
0	0	0	1	8
1	1	1	1	15

6. 0 = 0 ± 0.2 V, 1 = 2.8 to 5.0 V

### Absolute Maximum Ratings<sup>7,8</sup>

Parameter	Absolute Maximum
Input Power 50 MHz 500 - 6000 MHz	+27 dBm +33 dBm
Control Voltage	-0.5 V ≤ $V_C$ ≤ 5.5 V
Operating Temperature	-40°C to +85°C
Storage Temperature	-65°C to +150°C

7. Exceeding any one or combination of these limits may cause permanent damage to this device.

8. MACOM does not recommend sustained operation near these survivability limits.

## Typical Performance Curves

**Insertion Loss**

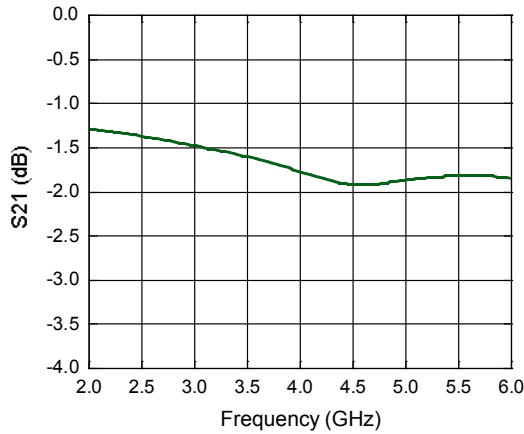

**Relative Attenuation across all states**

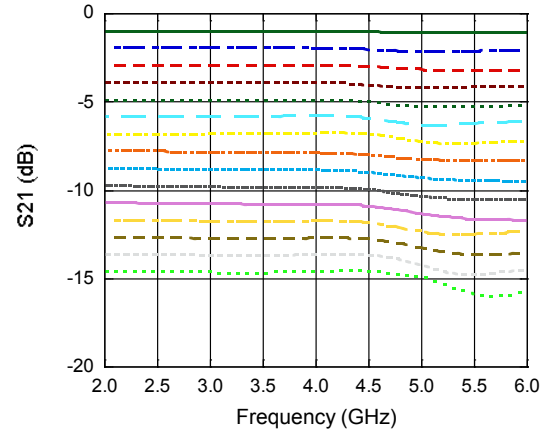

**Input Return Loss, Insertion Loss State**

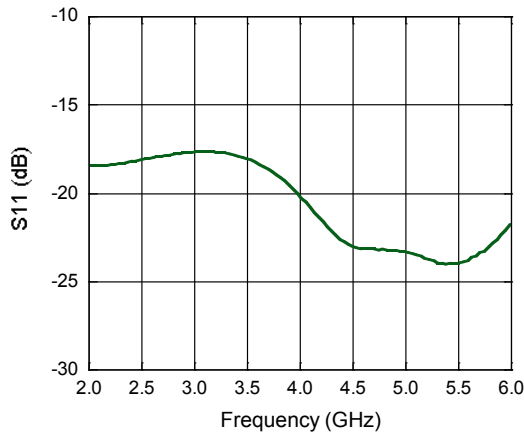

**Input Return Loss, across all attenuation states**

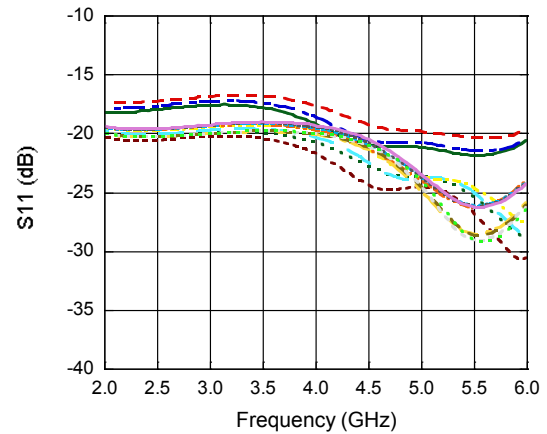

**Output Return Loss, Insertion Loss State**

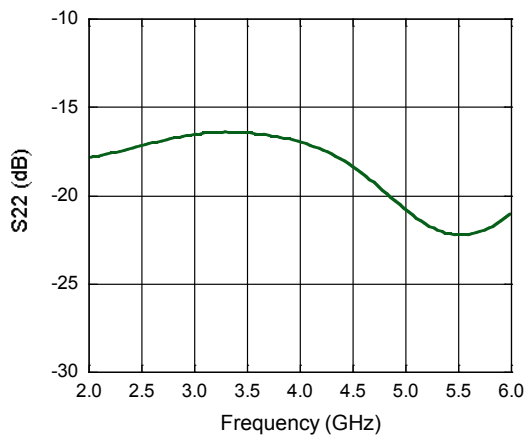

**Output Return Loss, across all attenuation states**

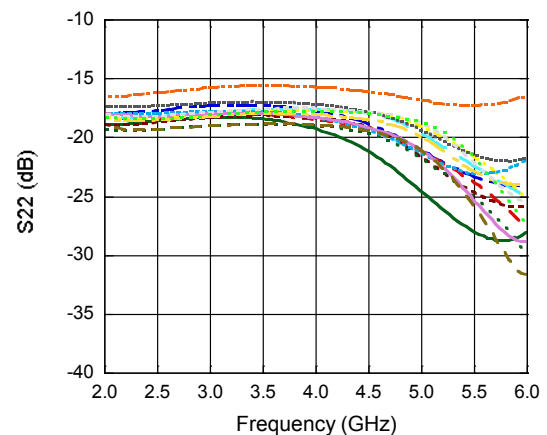

**Lead Free 3 mm 16-Lead PQFN †**

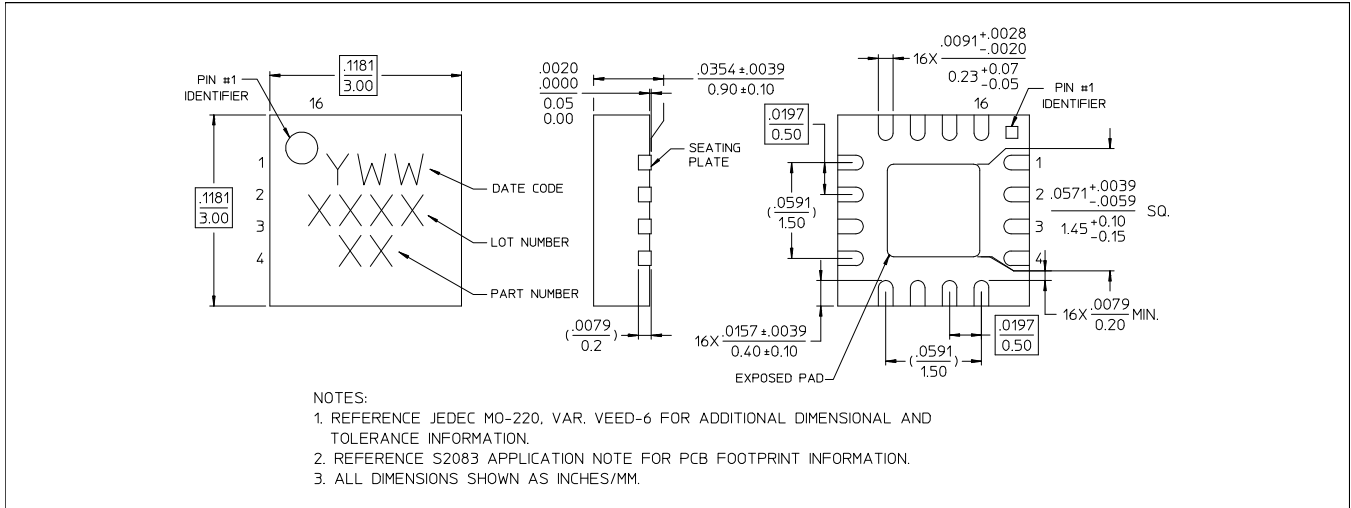

† Reference Application Note S2038 for lead-free solder reflow recommendations.  
 Meets JEDEC moisture sensitivity level 1 requirements.  
 Plating is 100% matte tin over copper.

## Handling Procedures

Please observe the following precautions to avoid damage:

## Static Sensitivity

Gallium Arsenide Integrated Circuits are sensitive to electrostatic discharge (ESD) and can be damaged by static electricity. Proper ESD control techniques should be used when handling these devices.

M/A-COM Technology Solutions Inc. All rights reserved.

Information in this document is provided in connection with M/A-COM Technology Solutions Inc ("MACOM") products. These materials are provided by MACOM as a service to its customers and may be used for informational purposes only. Except as provided in MACOM's Terms and Conditions of Sale for such products or in any separate agreement related to this document, MACOM assumes no liability whatsoever. MACOM assumes no responsibility for errors or omissions in these materials. MACOM may make changes to specifications and product descriptions at any time, without notice. MACOM makes no commitment to update the information and shall have no responsibility whatsoever for conflicts or incompatibilities arising from future changes to its specifications and product descriptions. No license, express or implied, by estoppel or otherwise, to any intellectual property rights is granted by this document.

THESE MATERIALS ARE PROVIDED "AS IS" WITHOUT WARRANTY OF ANY KIND, EITHER EXPRESS OR IMPLIED, RELATING TO SALE AND/OR USE OF MACOM PRODUCTS INCLUDING LIABILITY OR WARRANTIES RELATING TO FITNESS FOR A PARTICULAR PURPOSE, CONSEQUENTIAL OR INCIDENTAL DAMAGES, MERCHANTABILITY, OR INFRINGEMENT OF ANY PATENT, COPYRIGHT OR OTHER INTELLECTUAL PROPERTY RIGHT. MACOM FURTHER DOES NOT WARRANT THE ACCURACY OR COMPLETENESS OF THE INFORMATION, TEXT, GRAPHICS OR OTHER ITEMS CONTAINED WITHIN THESE MATERIALS. MACOM SHALL NOT BE LIABLE FOR ANY SPECIAL, INDIRECT, INCIDENTAL, OR CONSEQUENTIAL DAMAGES, INCLUDING WITHOUT LIMITATION, LOST REVENUES OR LOST PROFITS, WHICH MAY RESULT FROM THE USE OF THESE MATERIALS.

MACOM products are not intended for use in medical, lifesaving or life sustaining applications. MACOM customers using or selling MACOM products for use in such applications do so at their own risk and agree to fully indemnify MACOM for any damages resulting from such improper use or sale.