

GTVA263202FC

Thermally-Enhanced High Power RF GaN on SiC Amplifier, 340 W, 48 V, 2620 – 2690 MHz



Package Types: H-37248-4

Description

The GTVA263202FC is a 340-watt (P_{3dB}) GaN on SiC HEMT D-mode amplifier for use in multi-standard cellular power amplifier applications. It features input matching, high efficiency, and a thermally-enhanced surface-mount package with earless flange.

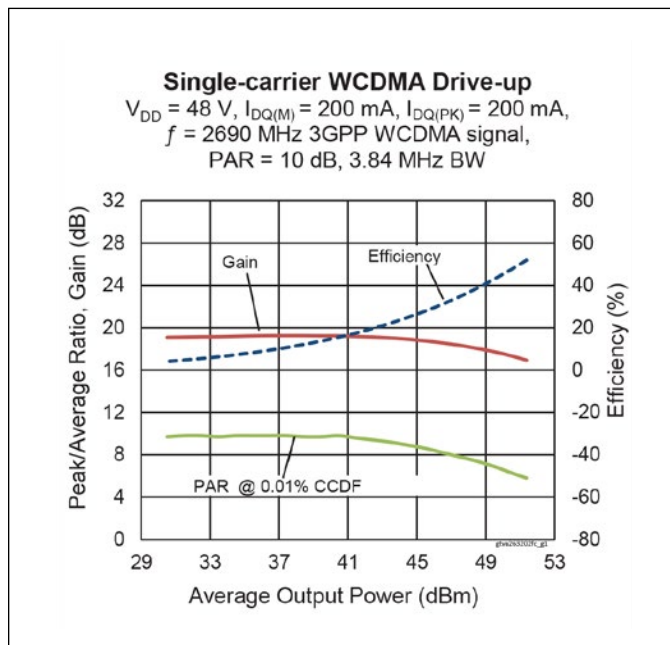

Features

- GaN on SiC HEMT technology
- Input matched
- Typical pulsed CW performance, 2690 MHz, 48 V, combined outputs
 - Output power at $P_{3dB} = 340\text{ W}$
 - Drain efficiency = 70%
 - Gain = 16 dB
- Capable of handling 10:1 VSWR @48 V, 80 W (CW) output power
- Human Body Model Class 1B (per ANSI/ESDA/ JEDEC JS-001)
- Low thermal resistance
- Pb-free and RoHS compliant

RF Characteristics

Single-carrier WCDMA Specifications (tested in the production test fixture)

$V_{DD} = 48\text{ V}$, $I_{DQ} = 200\text{ mA}$ (per side), $P_{OUT} = 80\text{ W}$ avg, $f = 2690\text{ MHz}$, 3GPP signal, channel bandwidth = 3.84 MHz, peak/average = 10 dB @ 0.01% CCDF

Characteristic	Symbol	Min.	Typ.	Max.	Unit
Gain	G_{ps}	16	17	—	dB
Drain Efficiency	η_D	34	40	—	%
Adjacent Channel Power Ratio	ACPR	—	-29	-26.5	dBc

Note:

All published data at $T_{CASE} = 25^\circ\text{C}$ unless otherwise indicated

ESD: Electrostatic discharge sensitive device—observe handling precautions!



DC Characteristics

Characteristic	Symbol	Min.	Typ.	Max.	Unit	Conditions
Drain-source Breakdown Voltage	$V_{BR(DSS)}$	150	—	—	V	$V_{GS} = -8\text{ V}, I_D = 21\text{ mA}$
Drain-source Leakage Current	I_{DSS}	—	—	5	mA	$V_{GS} = -8\text{ V}, V_{DS} = 10\text{ V}$
Gate Threshold Voltage	$V_{GS(th)}$	-3.8	-3.0	-2.3	V	$V_{DS} = 10\text{ V}, I_D = 21\text{ mA}$

Recommended Operating Conditions

Parameter	Symbol	Min.	Typ.	Max.	Unit	Conditions
Drain Operating Voltage	V_{DD}	0	—	50	V	$V_{DS} = 50\text{ V}, I_D = 200\text{ mA}$
Gate Quiescent Voltage	$V_{GS(Q)}$	—	-2.8	—		

Absolute Maximum Ratings

Parameter	Symbol	Value	Unit
Drain-source Voltage	V_{DSS}	125	V
Gate-source Voltage	V_{GS}	-10 to +2	
Gate Current	I_G	20	mA
Drain Current	I_D	7.5	A
Junction Temperature	T_J	225	°C
Storage Temperature Range	T_{STG}	-65 to +150	

Operation above the maximum values listed here may cause permanent damage. Maximum ratings are absolute ratings; exceeding only one of these values may cause irreversible damage to the component. Exposure to absolute maximum rating conditions for extended periods may affect device reliability. For reliable continuous operation, the device should be operated within the operating voltage range (V_{DD}) specified above.

Thermal Characteristics

Characteristic	Symbol	Value	Unit	Conditions
Thermal Resistance	$R_{\theta JC}$	0.5	°C/W	$T_{CASE} = 70\text{ °C}, 80\text{ W (CW)}$

Ordering Information

Type and Version	Order Code	Package Description	Shipping
GTVA263202FC V1 R0	GTVA263202FC-V1-R0	H-37248-4, earless flange	Tape & Reel, 50 pcs
GTVA263202FC V1 R2	GTVA263202FC-V1-R2	H-37248-4, earless flange	Tape & Reel, 250 pcs

Typical Performance (data taken in a production test fixture)

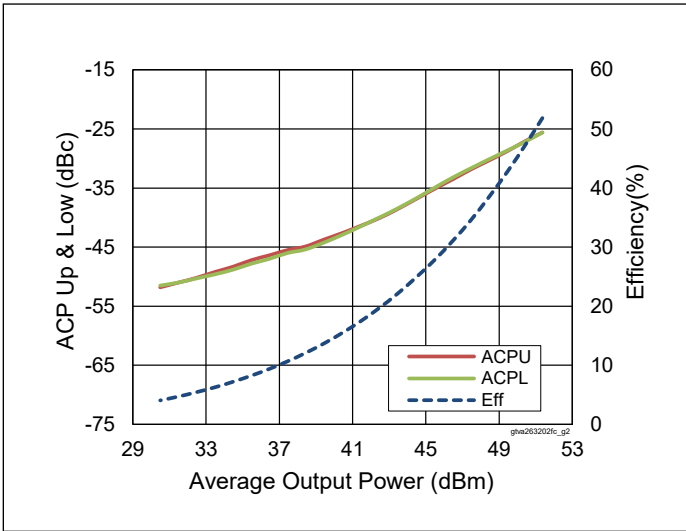

Figure 1. Single-carrier WCDMA Drive-up

$V_{DD} = 48\text{ V}$, $I_{DQ(M)} = 200\text{ mA}$, $I_{DQ(PK)} = 200\text{ mA}$,
 $f = 2690\text{ MHz}$, 3GPP WCDMA signal,
 $PAR = 10\text{ dB}$, $BW = 3.84\text{ MHz}$

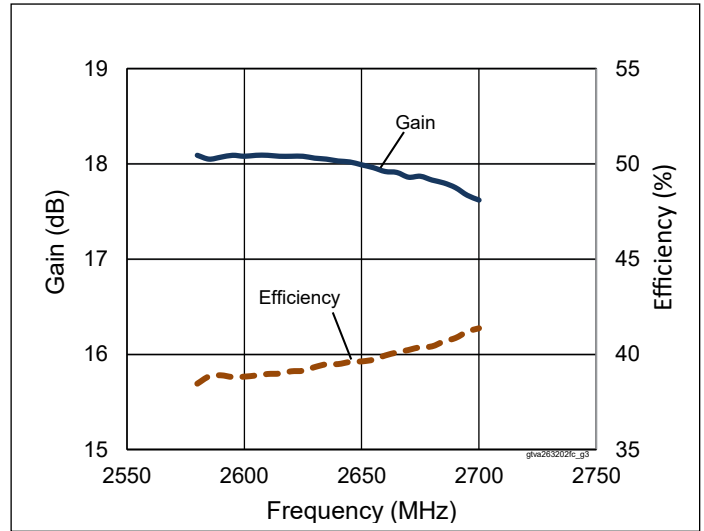

Figure 2. Single-carrier WCDMA Broadband Performance

$V_{DD} = 48\text{ V}$, $I_{DQ(M)} = 200\text{ mA}$, $I_{DQ(PK)} = 200\text{ mA}$,
 $P_{OUT} = 49.03\text{ dBm}$, 3GPP WCDMA signal,
 $PAR = 10\text{ dB}$

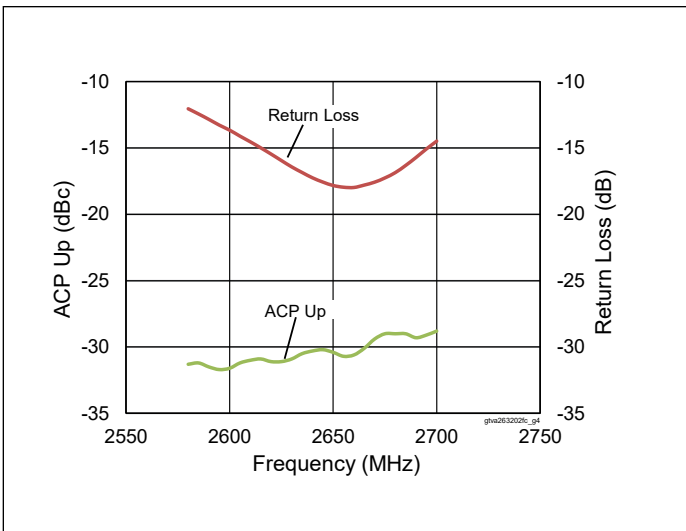

Figure 3. Single-carrier WCDMA Broadband Performance

$V_{DD} = 48\text{ V}$, $I_{DQ(M)} = 200\text{ mA}$, $I_{DQ(PK)} = 200\text{ mA}$,
 $P_{OUT} = 49.03\text{ dBm}$, 3GPP WCDMA signal,
 $PAR = 10\text{ dB}$

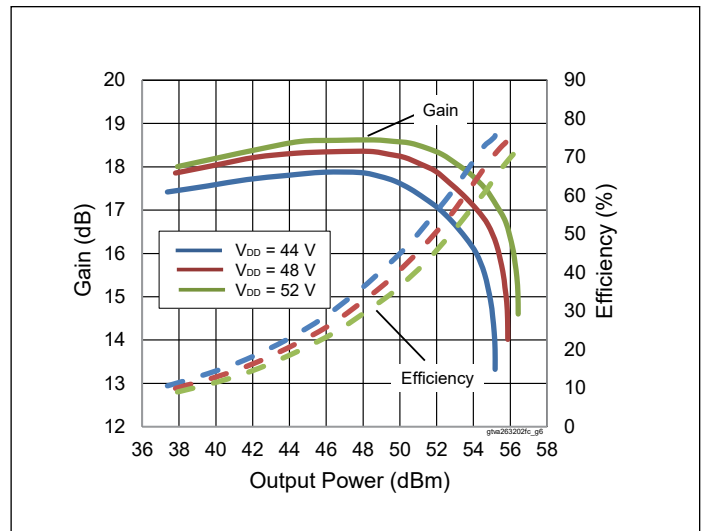

Figure 4. CW Performance at Various V_{DD}

$I_{DQ(M)} = 200\text{ mA}$, $I_{DQ(PK)} = 200\text{ mA}$, $f = 2690\text{ MHz}$

Typical Performance (cont.)

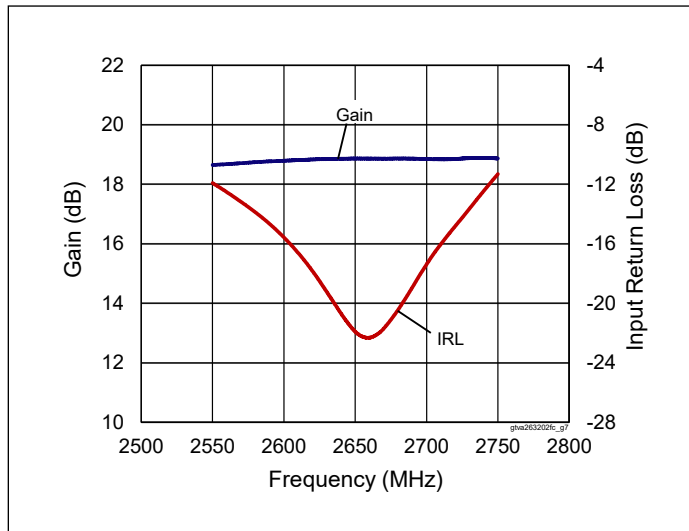

Figure 5. Small Signal CW Gain & Input Return Loss

$$V_{DD} = 48 \text{ V}, I_{DQ(M)} = 200 \text{ mA}, I_{DQ(PK)} = 200 \text{ mA}$$

Load Pull Performance

Load Pull Performance (per side) – Pulsed CW signal: 10 μ s, 10% duty cycle, 48 V, $I_{DQ} = 200$ mA

		P_{3dB}									
		Max Output Power					Max PAE				
Freq [MHz]	$Z_S [\Omega]$	$Z_L [\Omega]$	Gain [dB]	$P_{OUT} [\text{dBm}]$	$P_{OUT} [\text{W}]$	PAE [%]	$Z_L [\Omega]$	Gain [dB]	$P_{OUT} [\text{dBm}]$	$P_{OUT} [\text{W}]$	PAE [%]
2620	8.5 - j7	2.45 - j3.5	14.95	53.75	237	65.9	2.0 - j1.1	16.36	51.13	130	77.3
2655	8.9 - j8.5	2.96 - j3.6	14.67	53.77	238	67.7	2.43 - j1.8	15.88	52.39	173	77.2
2690	9.7 - j9.7	3.0 - j3.86	14.5	53.75	237	68.2	2.17 - j1.9	15.84	52.02	159	77.6

Evaluation Board, 2620 – 2690 MHz

Evaluation Board Part Number	LTN/GTVA263202FC-V1
PCB Information	Rogers 4350, 0.508 mm [0.020"] thick, 2 oz. copper, $\epsilon_r = 3.66$, $f = 2620 - 2690$ MHz

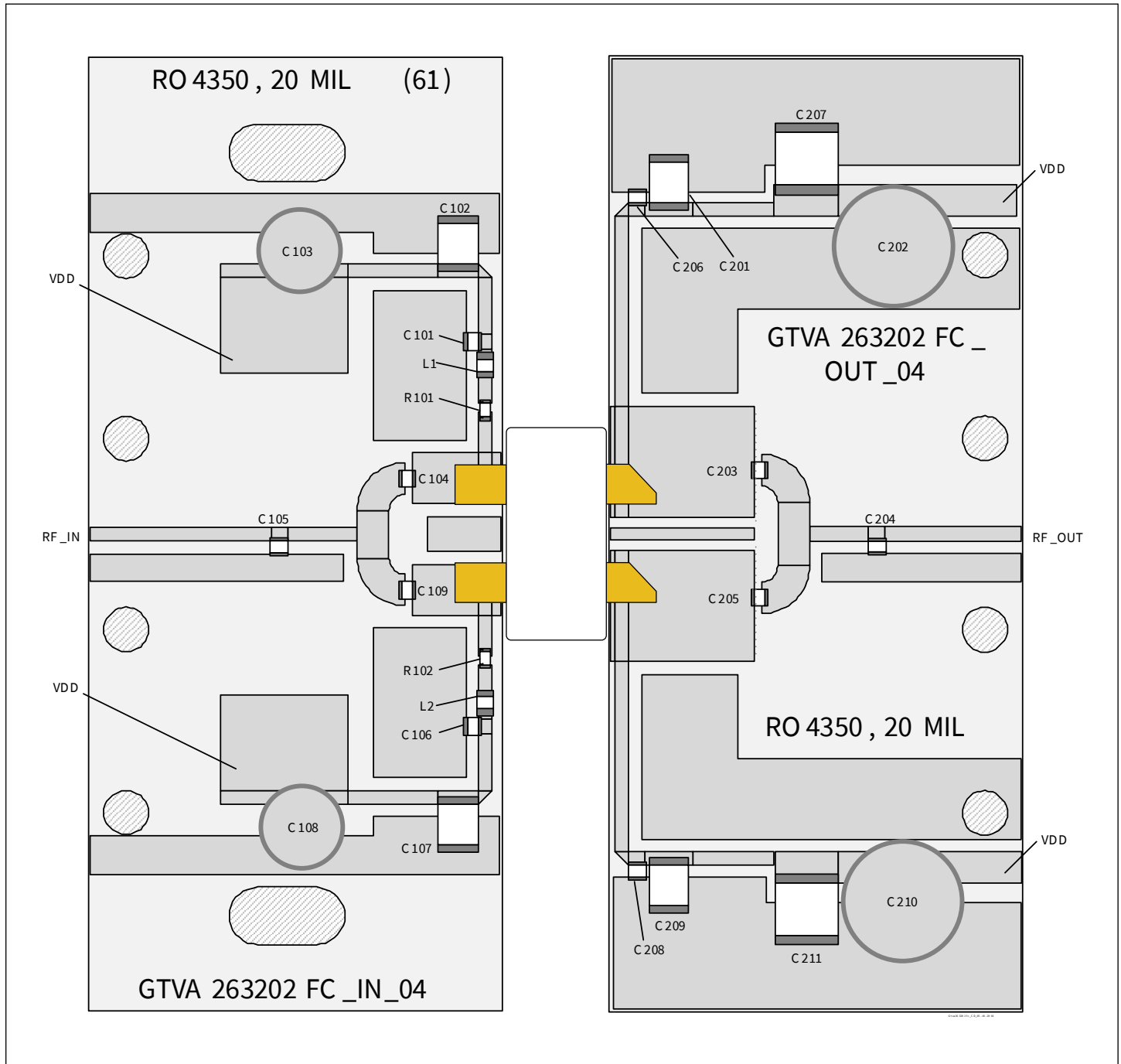

Reference circuit assembly diagram (not to scale)

Components Information

Component	Description	Manufacturer	P/N
Input			
C101, C104, C106, C109	Capacitor, 10 pF	ATC	ATC800A100JT250T
C102, C107	Capacitor, 1 μ F	TDK Corporation	C4532X7R2A105M230KA
C103, C108	Capacitor, 10 μ F	Panasonic Electronic Components	EEE-HB1H100AP
C105	Capacitor, 1 pF	ATC	ATC800A1R0CT250T
L1, L2	Inductor, 12 nH	Coilcraft	0908SQ-12NGLB
R101, R102	Resistor, 5.6 ohms	Panasonic Electronic Components	ERJ-3GEYJ5R6V
Output			
C201, C209	Capacitor, 1 μ F	TDK Corporation	C4532X7R2A105M230KA
C202, C210	Capacitor, 220 μ F	Panasonic Electronic Components	ECA-2AHG221
C203, C205, C206, C208	Capacitor, 10 pF	ATC	ATC800A100JT250T
C204	Capacitor, 1.4 pF	ATC	ATC800A1R4CT250T
C207, C211	Capacitor, 10 μ F	TDK Corporation	C5750X7S2A106M230KB

Bias Sequencing

Bias On

1. Ensure RF is turned off
2. Apply pinch-off voltage of -5 V to the gate
3. Apply nominal drain voltage
4. Bias gate to desired quiescent drain current
5. Apply RF

Bias Off

1. Turn RF off
2. Apply pinch-off voltage to the gate
3. Turn-off drain voltage
4. Turn-off gate voltage

Pinout Diagram (top view)

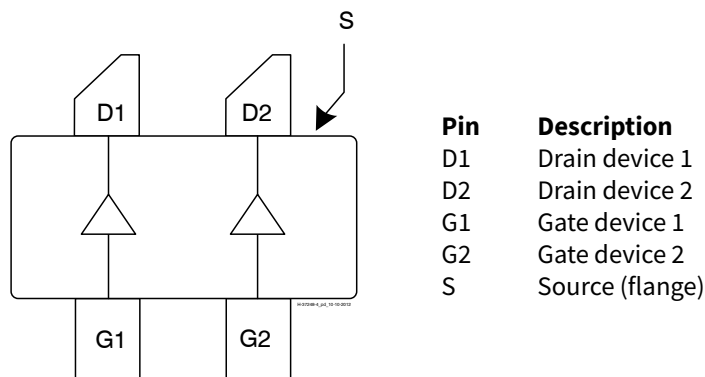

Package Outline Specifications – Package H-37248-4

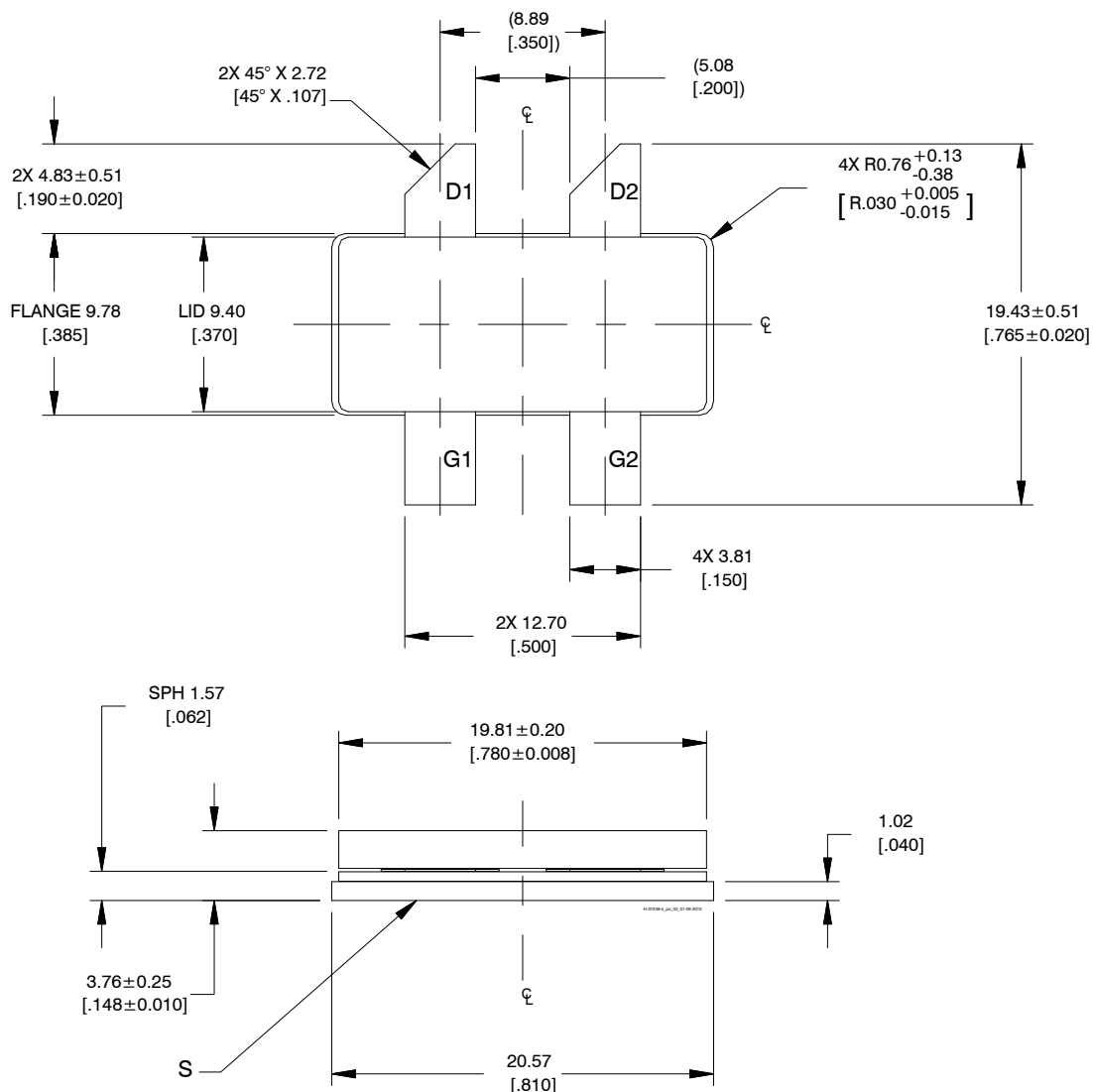

Diagram Notes—unless otherwise specified:

1. Interpret dimensions and tolerances per ASME Y14.5M-1994.
2. Primary dimensions are mm. Alternate dimensions are inches.
3. All tolerances ± 0.127 [.005] unless specified otherwise.
4. Pins: D1, D2 – drains; G1, G2 – gates; S – source.
5. Lead thickness: $0.10 + 0.076 / -0.025$ mm [$0.004 + 0.003 / -0.001$ inch].
6. Gold plating thickness: 1.14 ± 0.38 micron [45 ± 15 microinch].

Notes & Disclaimer

MACOM Technology Solutions Inc. ("MACOM"). All rights reserved.

These materials are provided in connection with MACOM's products as a service to its customers and may be used for informational purposes only. Except as provided in its Terms and Conditions of Sale or any separate agreement, MACOM assumes no liability or responsibility whatsoever, including for (i) errors or omissions in these materials; (ii) failure to update these materials; or (iii) conflicts or incompatibilities arising from future changes to specifications and product descriptions, which MACOM may make at any time, without notice. These materials grant no license, express or implied, to any intellectual property rights.

THESE MATERIALS ARE PROVIDED "AS IS" WITH NO WARRANTY OR LIABILITY, EXPRESS OR IMPLIED, RELATING TO SALE AND/OR USE OF MACOM PRODUCTS INCLUDING FITNESS FOR A PARTICULAR PURPOSE, MERCHANTABILITY, INFRINGEMENT OF INTELLECTUAL PROPERTY RIGHT, ACCURACY OR COMPLETENESS, OR SPECIAL, INDIRECT, INCIDENTAL, OR CONSEQUENTIAL DAMAGES WHICH MAY RESULT FROM USE OF THESE MATERIALS.

MACOM products are not intended for use in medical, lifesaving or life sustaining applications. MACOM customers using or selling MACOM products for use in such applications do so at their own risk and agree to fully indemnify MACOM for any damages resulting from such improper use or sale.