

Double Balanced Mixer

3 - 10 GHz



CGY2182UH/C1

Rev. V1

Features

- RF and LO Range: 3 - 10 GHz
- IF Range: DC - 3 GHz
- Conversion Loss: 60 dB
- LO to RF Isolation: 45 dB
- LO to IF Isolation: 32 dB
- Input P1dB: 12 dBm
- Small Chip Size: 1.5 x 1.5 x 0.1 mm
- Tested, Inspected Known Good Die (KGD)
- Evaluation Boards Available
- Space and MIL-STD also Available
- RoHS* Compliant

Applications

- GPS Systems
- Radar
- Telecommunication
- Instrumentation

Description

The CGY2182UH/C1 is a high performance GaAs pHEMT technology based double balanced mixer MMIC with on chip RF and LO baluns. This device covers the frequency range of 3 GHz to 10 GHz with a conversion loss of typically 7 dB. On-chip baluns provide excellent rejection of LO to RF and IF paths. High dynamic range is provided by the passive mixer configuration.

The die is manufactured using 0.18 μm gate length pHEMT Technology. The MMIC uses gold bond pads and backside metallization and is fully protected with Silicon Nitride passivation to obtain the highest level of reliability. This technology has been evaluated for Space applications and is on the European Preferred Parts List of the European Space Agency.

Block Diagram

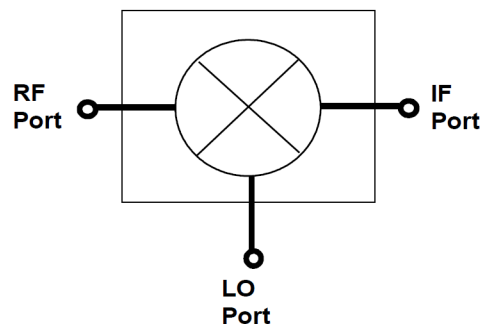

Ordering Information

Part Number	Package
CGY2182UH/C1	Double balanced quad mixer
CGY2182GS/C1	Hermetically sealed double balanced quad mixer

* Restrictions on Hazardous Substances, compliant to current RoHS EU directive.

Double Balanced Mixer

3 - 10 GHz



CGY2182UH/C1

Rev. V1

Electrical Specifications: Down Converter Mode, Measured on Wafer, LO Power = +15 dBm

Parameter	Test Conditions	Units	Min.	Typ.	Max.
LO and RF Frequency	—	GHz	3	—	10
IF Frequency	—	GHz	DC	—	3
Conversion Loss	—	dB	—	7	10
SSB Noise Figure	—	dB	—	7	—
Isolation	LO to RF (Up Converter Mode) LO to IF	dB	—	60 45	—
P1dB	—	dBm	—	12	—

Absolute Maximum Ratings^{1,2}

Parameter	Absolute Maximum
Input Power	
LO	17.5 dBm
RF	15.0 dBm
IF	15.0 dBm
Junction Temperature	+150°C
Operating Temperature	-40°C to +85°C
Storage Temperature	-55°C to +150°C

- Exceeding any one or combination of these limits may cause permanent damage to this device.
- MACOM does not recommend sustained operation near these survivability limits.

Handling Procedures

Please observe the following precautions to avoid damage:

Static Sensitivity

These electronic devices are sensitive to electrostatic discharge (ESD) and can be damaged by static electricity. Proper ESD control techniques should be used when handling these devices.

Double Balanced Mixer

3 - 10 GHz



CGY2182UH/C1

Rev. V1

Typical Performance Curves: Down Conversion Mode

LO Power: +15 dBm, RF Power: -15 dBm, IF Frequency: 0.1 GHz

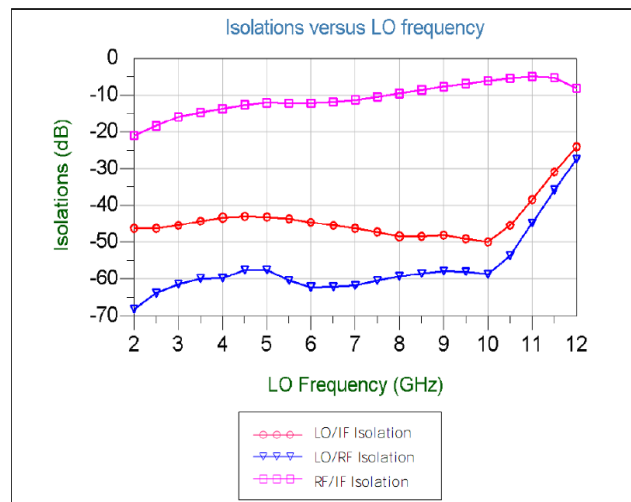
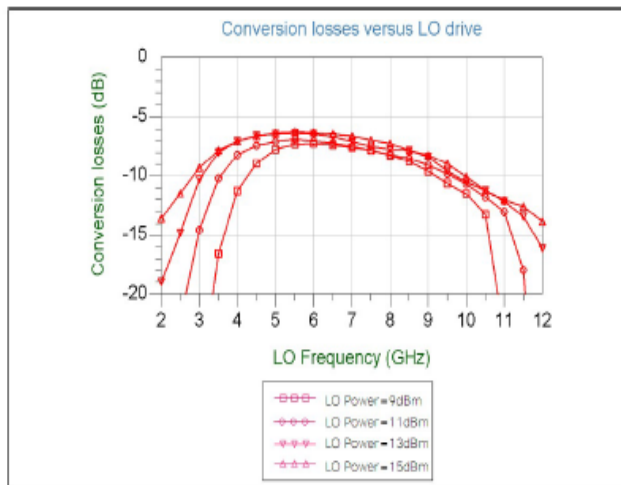
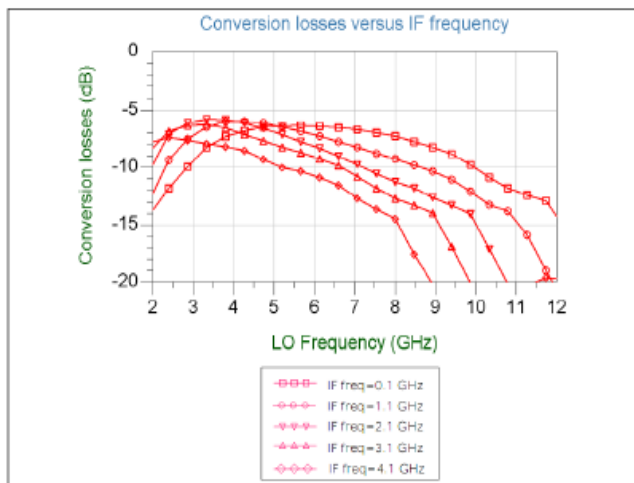
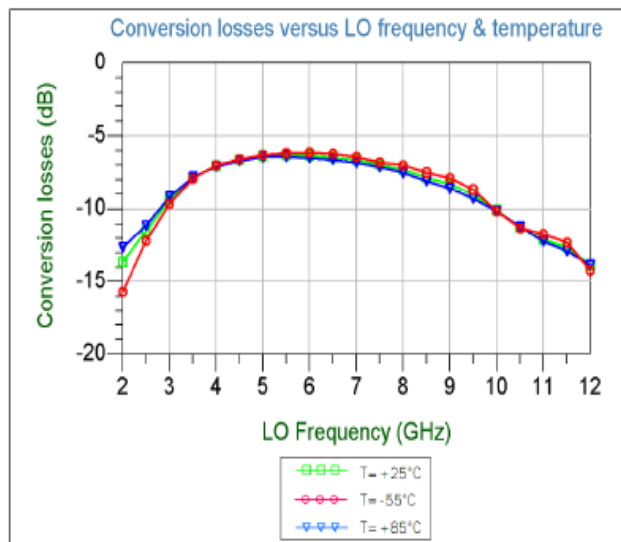
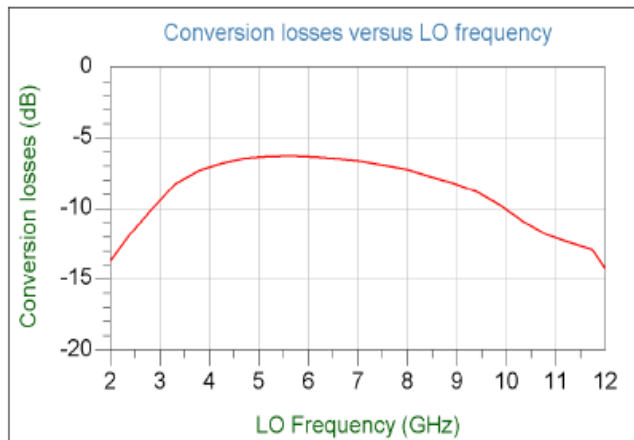

3

MACOM Technology Solutions Inc. (MACOM) and its affiliates reserve the right to make changes to the product(s) or information contained herein without notice. Visit www.macom.com for additional data sheets and product information.

For further information and support please visit: <https://www.macom.com/support>

DC-0029687

Double Balanced Mixer

3 - 10 GHz



CGY2182UH/C1
Rev. V1

Typical Performance Curves: Up Conversion Mode
LO Power: +15 dBm, IF Power: -15 dBm, IF Frequency: 0.1 GHz

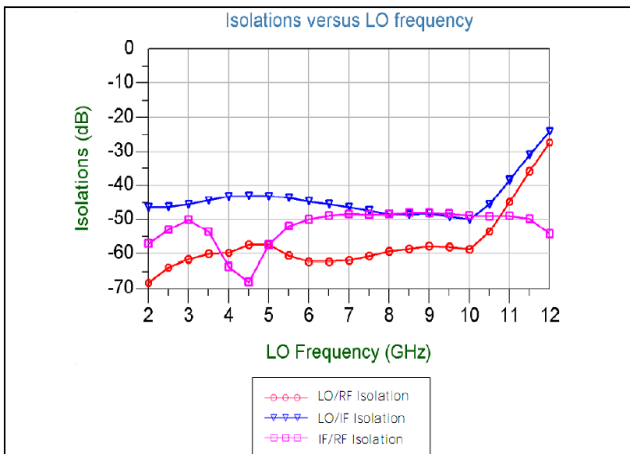
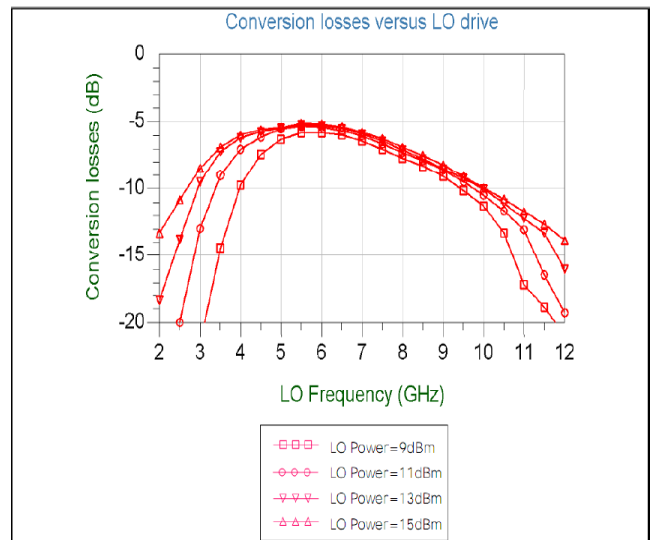
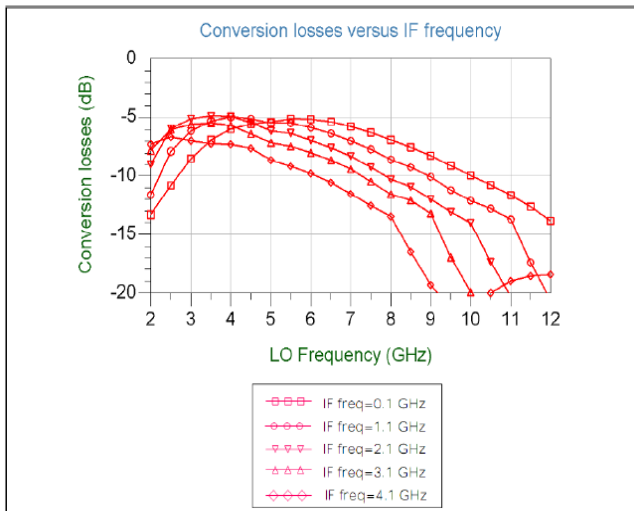
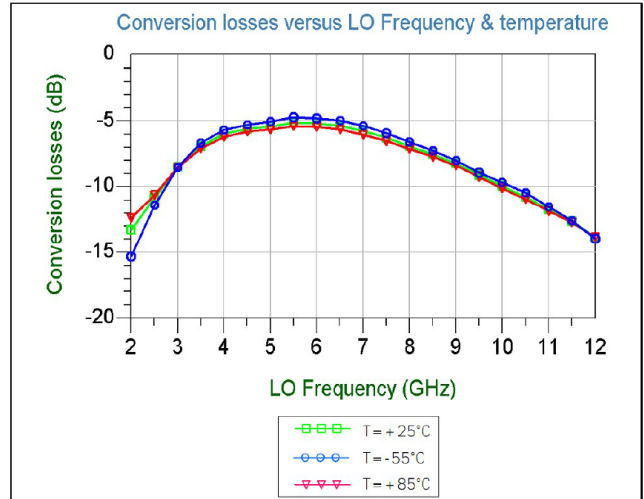
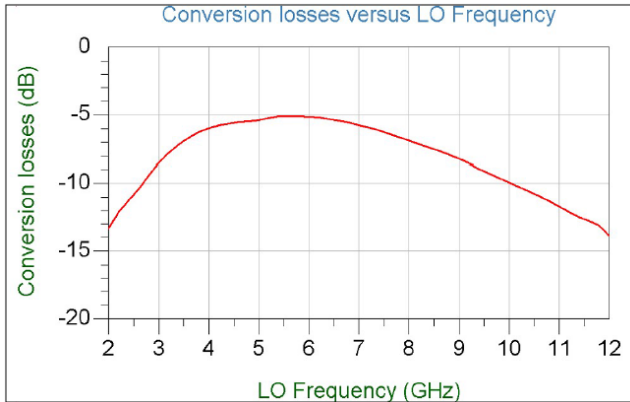

4

MACOM Technology Solutions Inc. (MACOM) and its affiliates reserve the right to make changes to the product(s) or information contained herein without notice. Visit www.macom.com for additional data sheets and product information.

For further information and support please visit: <https://www.macom.com/support>

DC-0029687

Double Balanced Mixer

3 - 10 GHz



CGY2182UH/C1

Rev. V1

Typical Performance Curves: Up or Down Conversion Mode

LO Power: +15 dBm, IF Power: -40 dBm

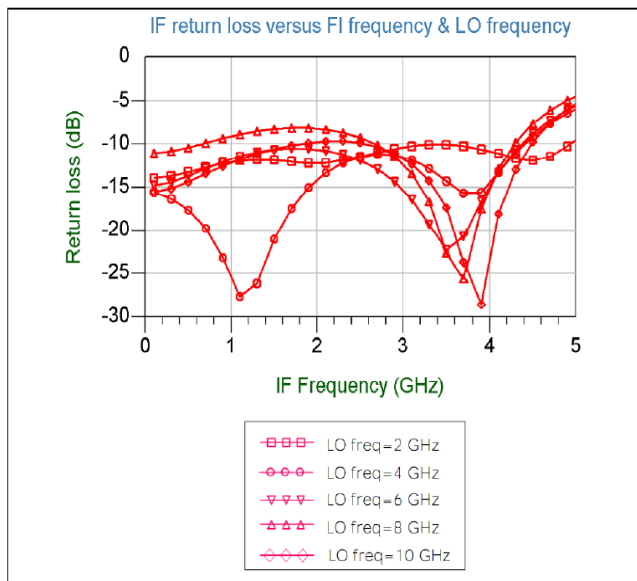

LO Power: +15 dBm, RF Power: -40 dBm

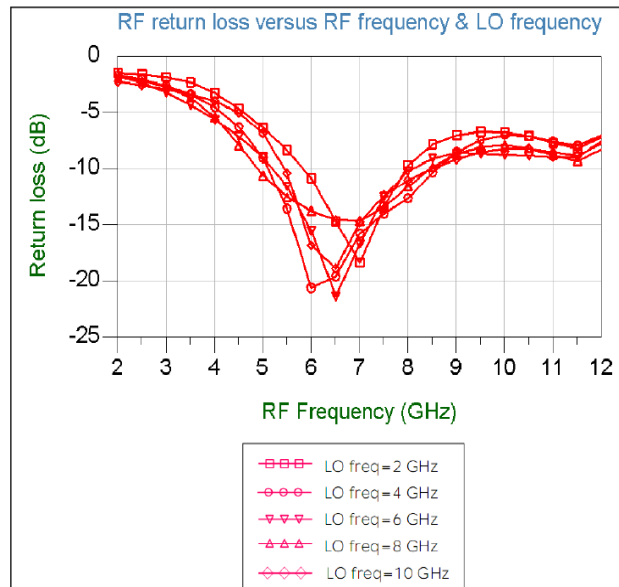

LO Power: +15 dBm, RF Power: -15 dBm

IF Frequency: 0.1 GHz

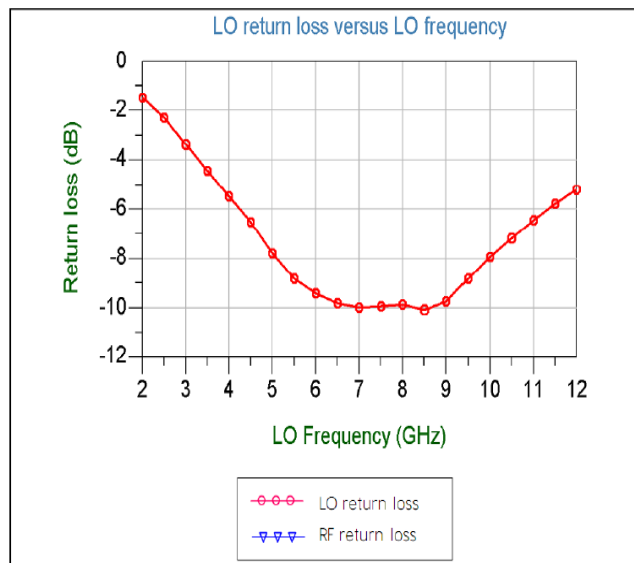

Double Balanced Mixer

3 - 10 GHz



CGY2182UH/C1

Rev. V1

Typical Performance Curves: IF Frequency: 0.1 GHz

Down Converter Mode

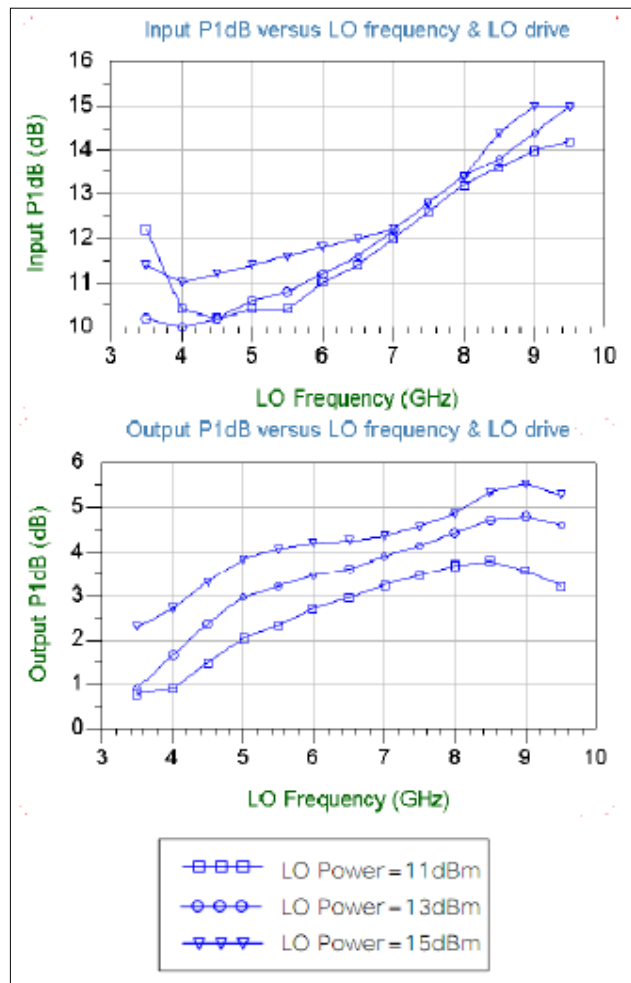

Up Converter Mode

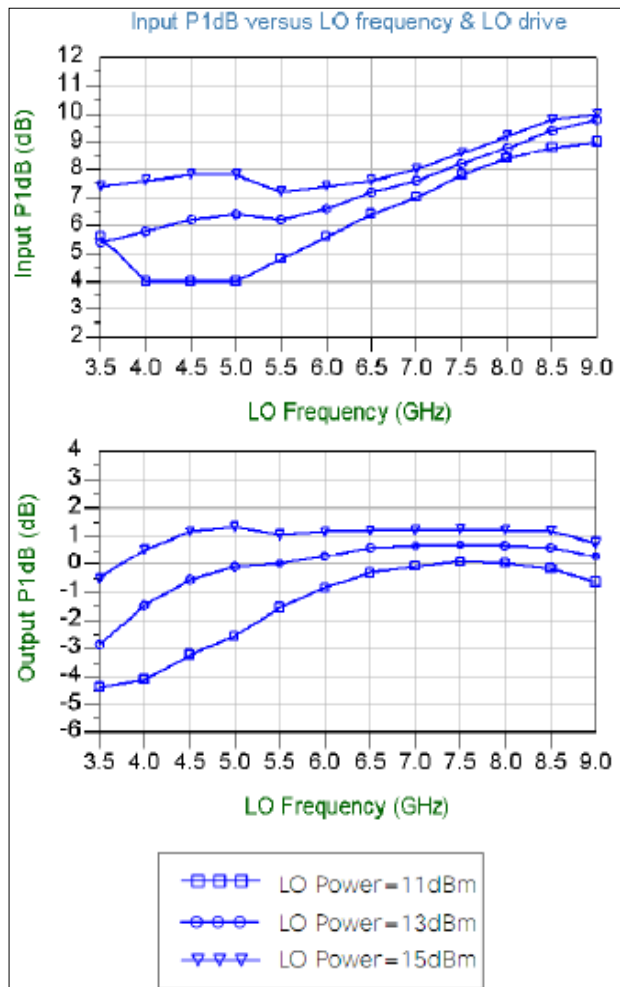

Double Balanced Mixer

3 - 10 GHz



CGY2182UH/C1
Rev. V1

Typical Performance Curves:

Down Converter Mode

LO Power: +13 dBm, RF Power: -10 dBm
IF Frequency: 0.1 GHz

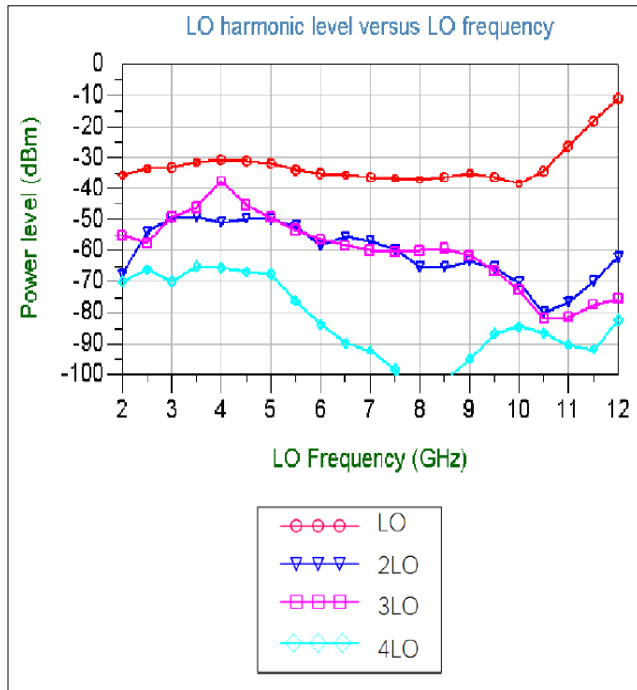

Up Converter Mode

LO Power: +13 dBm, IF Power: -10 dBm
IF Frequency: 0.1 GHz

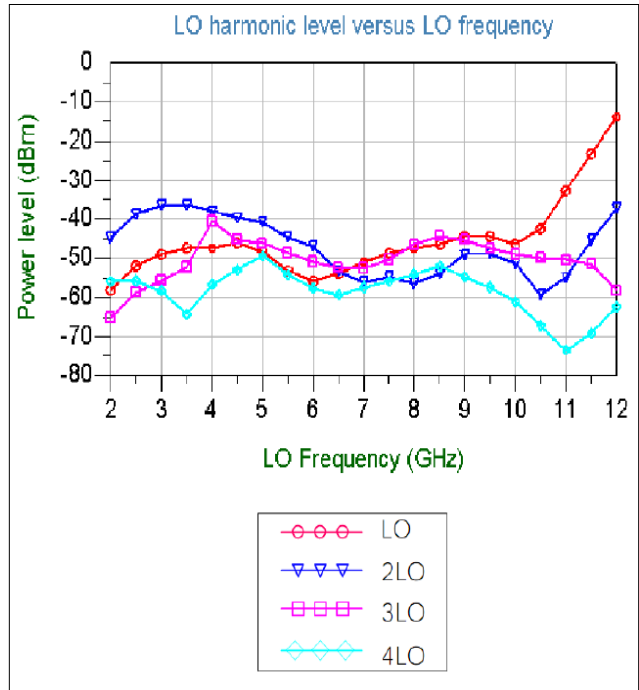

Double Balanced Mixer

3 - 10 GHz



CGY2182UH/C1
Rev. V1

Block Diagram

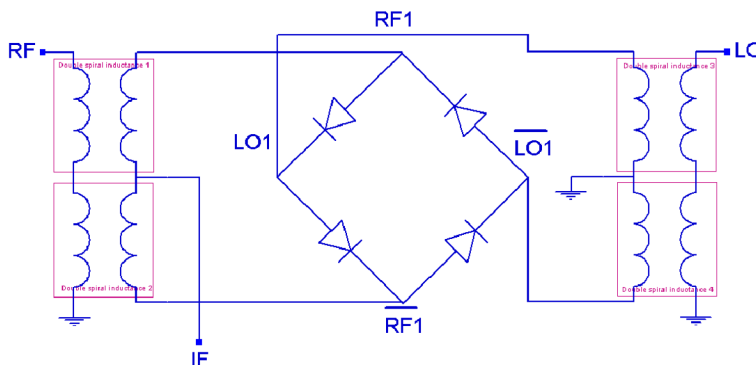

Pad Position

Pad Name	Coordinate		Description
	X (μm)	Y (μm)	
LO	460	1353	Local Oscillator Input
RF	460	112	RF Input
IF	1353	689	IF Output

X=0, Y=0 at bottom left corner.
Co-ordinates correspond to the center of the bonding pad.
See Mechanical Information for more details.

Bonding Diagram & Assembly Information

The bonding wires should be gold and be as short as possible. The CGY2182UH/C1 uses through substrate via holes to obtain excellent RF grounding. The backside of the MMIC must be appropriately connected to the system ground.

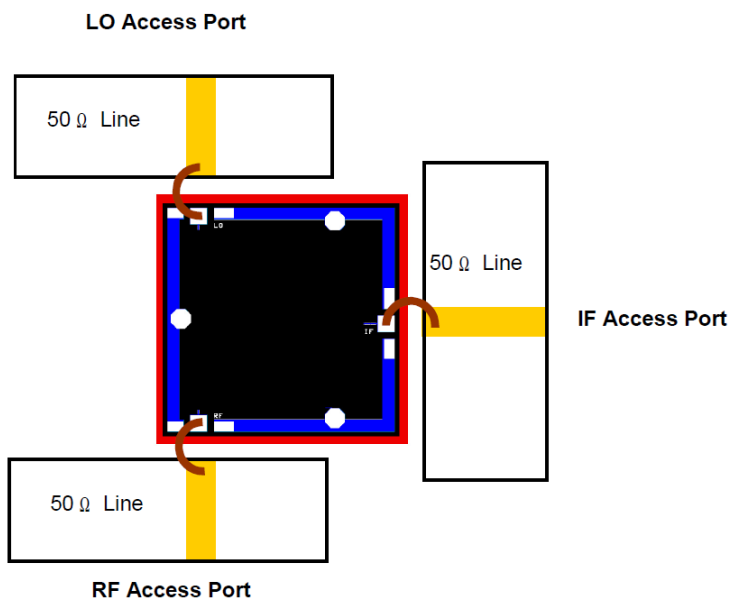

Double Balanced Mixer

3 - 10 GHz



CGY2182UH/C1

Rev. V1

Mechanical Information

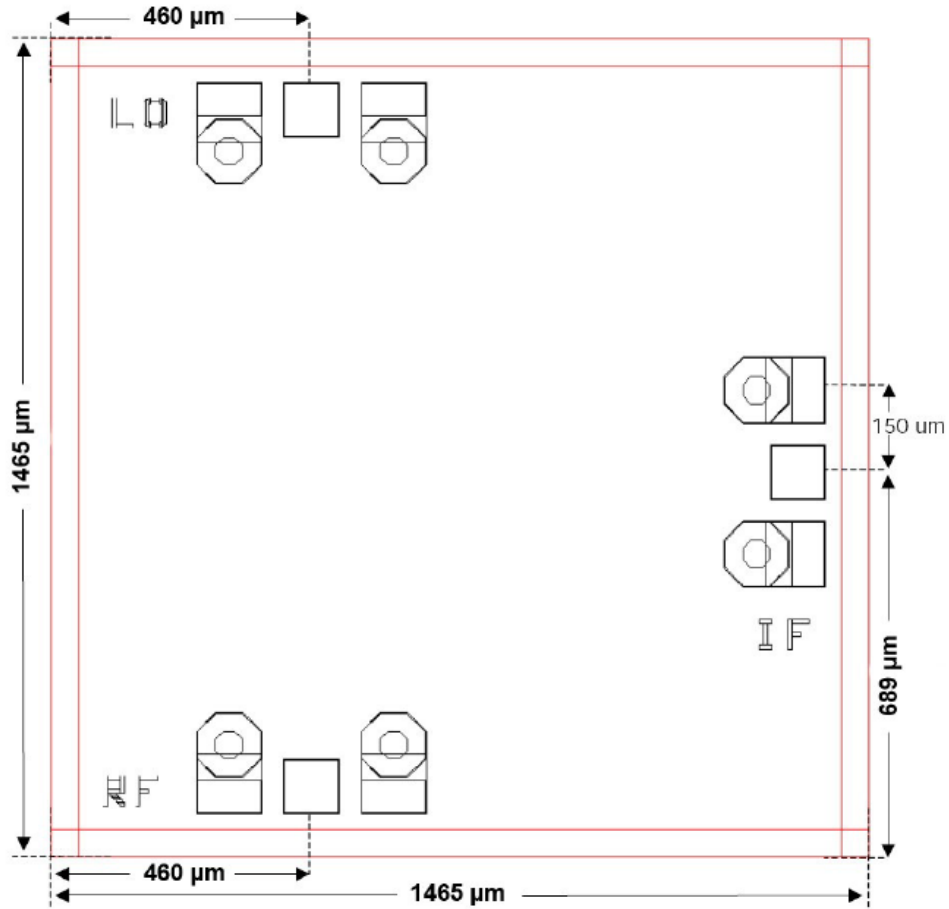

Chip Size: 1465 μm x 1465 μm (after wafer sawing)
Substrate Thickness: 100 μm
Back-Side Metallization: yes
Use of Via-Holes: yes
RF Pads Size: 100 x 100 μm

Double Balanced Mixer

3 - 10 GHz



CGY2182UH/C1

Rev. V1

MACOM Technology Solutions Inc. ("MACOM"). All rights reserved.

These materials are provided in connection with MACOM's products as a service to its customers and may be used for informational purposes only. Except as provided in its Terms and Conditions of Sale or any separate agreement, MACOM assumes no liability or responsibility whatsoever, including for (i) errors or omissions in these materials; (ii) failure to update these materials; or (iii) conflicts or incompatibilities arising from future changes to specifications and product descriptions, which MACOM may make at any time, without notice. These materials grant no license, express or implied, to any intellectual property rights.

THESE MATERIALS ARE PROVIDED "AS IS" WITH NO WARRANTY OR LIABILITY, EXPRESS OR IMPLIED, RELATING TO SALE AND/OR USE OF MACOM PRODUCTS INCLUDING FITNESS FOR A PARTICULAR PURPOSE, MERCHANTABILITY, INFRINGEMENT OF INTELLECTUAL PROPERTY RIGHT, ACCURACY OR COMPLETENESS, OR SPECIAL, INDIRECT, INCIDENTAL, OR CONSEQUENTIAL DAMAGES WHICH MAY RESULT FROM USE OF THESE MATERIALS.

MACOM products are not intended for use in medical, lifesaving or life sustaining applications. MACOM customers using or selling MACOM products for use in such applications do so at their own risk and agree to fully indemnify MACOM for any damages resulting from such improper use or sale.