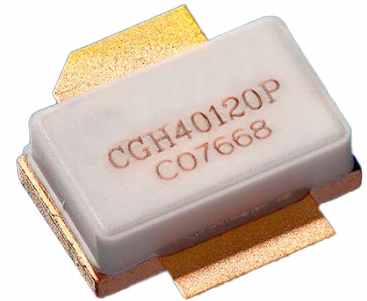


# CGH40120P

120 W, RF Power GaN HEMT

## Description

The CGH40120P is an unmatched, gallium nitride (GaN) high electron mobility transistor (HEMT). The CGH40120P, operating from a 28 volt rail, offers a general purpose, broadband solution to a variety of RF and microwave applications. GaN HEMTs offer high efficiency, high gain and wide bandwidth capabilities making the CGH40120P ideal for linear and compressed amplifier circuits. The transistor is available in a metal-ceramic pill package.



Package Types: 440206  
PN's: CGH40120P

## Features

- Up to 2.5 GHz Operation
- 20 dB Small Signal Gain at 1.0 GHz
- 15 dB Small Signal Gain at 2.0 GHz
- 120 W Typical  $P_{SAT}$
- 70% Efficiency at  $P_{SAT}$
- 28 V Operation

## Applications

- 2-Way Private Radio
- Broadband Amplifiers
- Cellular Infrastructure
- Test Instrumentation
- Class A, AB, Linear amplifiers suitable for OFDM, W-CDMA, EDGE, CDMA waveforms



Large Signal Models Available for ADS and MWO



### Absolute Maximum Ratings (not simultaneous) at 25°C Case Temperature

Parameter	Symbol	Rating	Units	Conditions
Drain-Source Voltage	$V_{DSS}$	120	V	25°C
Gate-to-Source Voltage	$V_{GS}$	-10, +2		
Storage Temperature	$T_{STG}$	-65, +150	°C	
Operating Junction Temperature	$T_J$	225		
Maximum Forward Gate Current	$I_{GMAX}$	30	mA	25°C
Maximum Drain Current <sup>1</sup>	$I_{DMAX}$	12	A	
Soldering Temperature <sup>2</sup>	$T_S$	245	°C	
Thermal Resistance, Junction to Case <sup>3</sup>	$R_{\theta JC}$	1.32	°C/W	85°C
Case Operating Temperature <sup>3,4</sup>	$T_C$	-40, +75	°C	

#### Notes:

<sup>1</sup> Current limit for long term, reliable operation

<sup>2</sup> Refer to the Application Note on soldering

<sup>3</sup> Measured for the CGH40120P at  $P_{DISS} = 115$  W

<sup>4</sup> See also, the Power Dissipation De-rating Curve on Page 6

### Electrical Characteristics ( $T_C = 25^\circ\text{C}$ )

Characteristics	Symbol	Min.	Typ.	Max.	Units	Conditions
<b>DC Characteristics<sup>1</sup></b>						
Gate Threshold Voltage	$V_{GS(th)}$	-3.8	-3.0	-2.3	$V_{DC}$	$V_{DS} = 10$ V, $I_D = 28.8$ mA
Gate Quiescent Voltage	$V_{GS(Q)}$	-	-2.7	-		$V_{DS} = 28$ V, $I_D = 1.0$ A
Saturated Drain Current <sup>2</sup>	$I_{DS}$	20.2	28.2	-	A	$V_{DS} = 6.0$ V, $V_{GS} = 2.0$ V
Drain-Source Breakdown Voltage	$V_{BR}$	84	-	-	$V_{DC}$	$V_{GS} = -8$ V, $I_D = 28.8$ mA
<b>RF Characteristics<sup>3</sup> (<math>T_C = 25^\circ\text{C}</math>, <math>F_0 = 1.3</math> GHz unless otherwise noted)</b>						
Power Gain	$G_{SS}$	14.6	15.5	-	dB	$V_{DD} = 28$ V, $I_{DQ} = 1.0$ A, $P_{IN} = 35$ dBm, Pulse Width = 100 usec, Duty Cycle = 10%
Power Output	$P_{SAT}$	93	100	-	W	
Drain Efficiency <sup>4</sup>	$\eta$	49.4	60	-	%	
Output Mismatch Stress	VSWR	-	-	10 : 1	Y	No damage at all phase angles, $V_{DD} = 28$ V, $I_{DQ} = 1.0$ A, $P_{OUT} = 100$ W CW
<b>Dynamic Characteristics</b>						
Input Capacitance	$C_{GS}$	-	35.3	-	pF	$V_{DS} = 28$ V, $V_{GS} = -8$ V, $f = 1$ MHz
Output Capacitance	$C_{DS}$	-	9.1	-		
Feedback Capacitance	$C_{GD}$	-	1.6	-		

#### Notes:

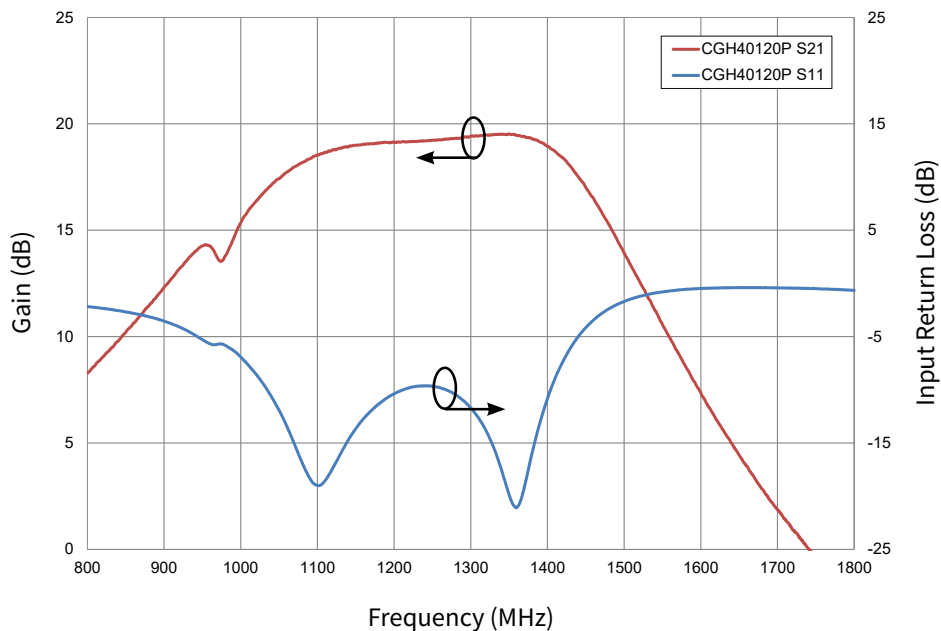
<sup>1</sup> Measured on wafer prior to packaging

<sup>2</sup> Scaled from PCM data

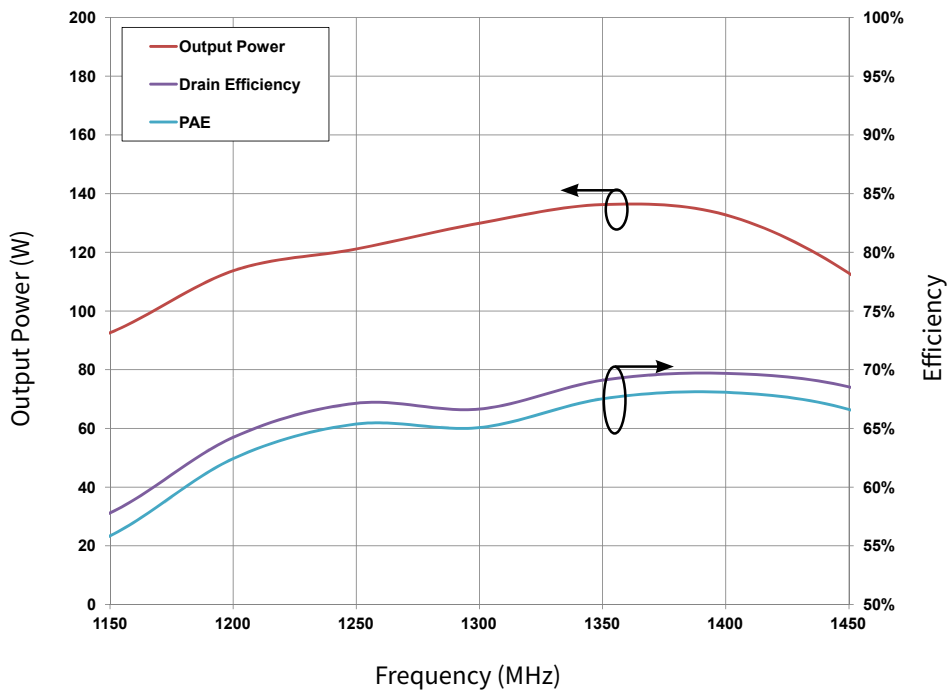
<sup>3</sup> Measured in CGH40120P-AMP

<sup>4</sup> Drain Efficiency =  $P_{OUT} / P_{DC}$

Typical Performance

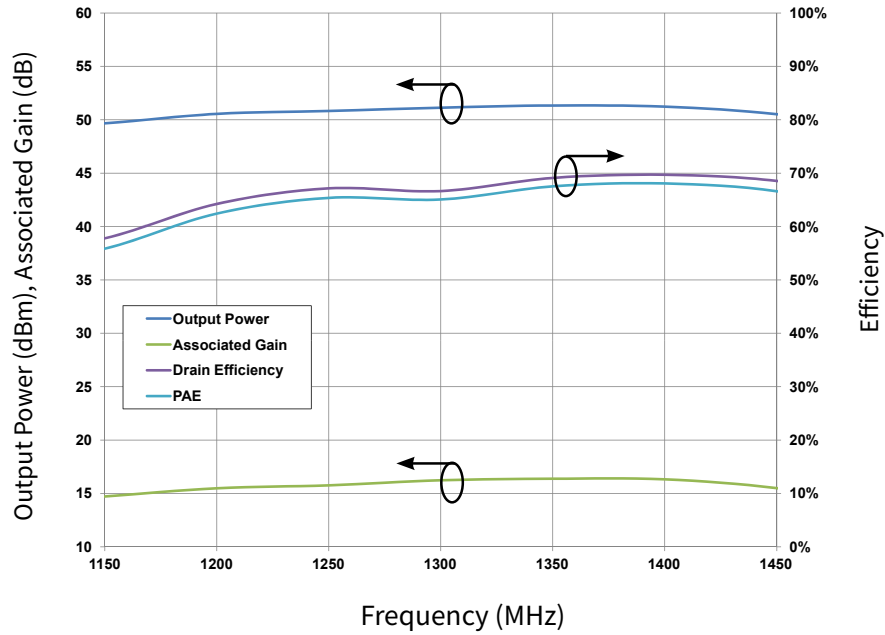


**Figure 1.** Gain and Input Return Loss vs Frequency measured in Broadband Amplifier Circuit CGH40120P-AMP  
 $V_{DD} = 28\text{ V}$ ,  $I_{DQ} = 1.0\text{ A}$



**Figure 2.** Gain, Output Power and PAE vs Frequency measured in Broadband Amplifier Circuit CGH40120P-AMP  
 $V_{DD} = 28\text{ V}$ ,  $I_{DQ} = 1.0\text{ A}$

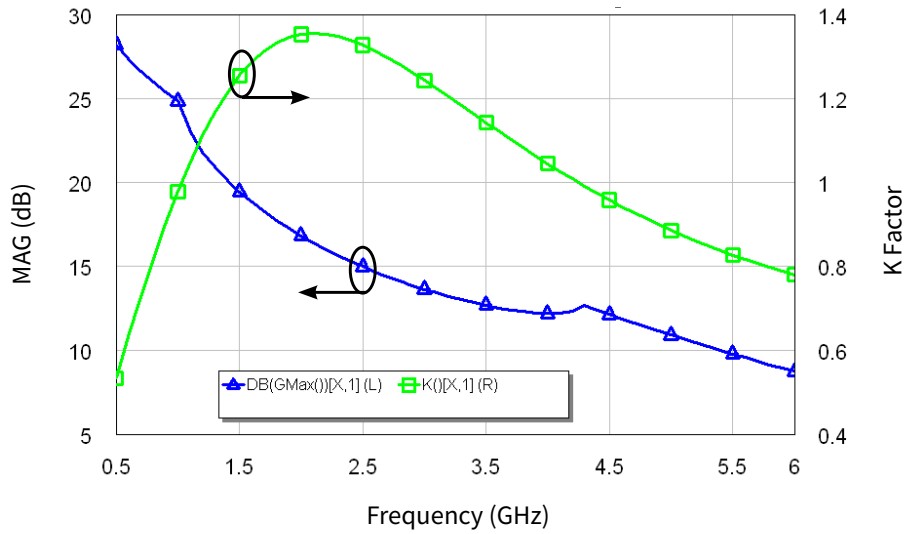
## Typical Performance



**Figure 3.** Associated Gain, Output Power, Drain Efficiency and PAE vs Frequency measured in Broadband Amplifier Circuit CGH40120P-AMP

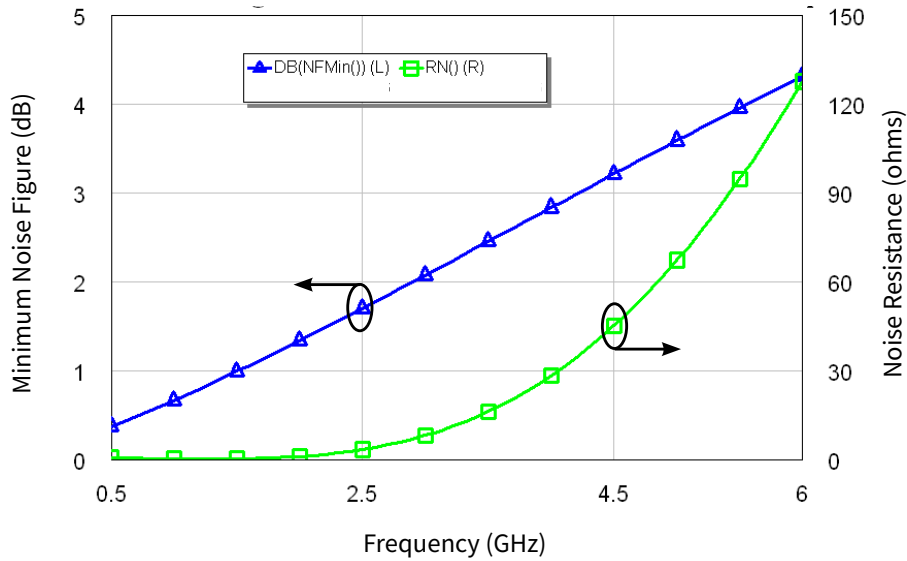
$$V_{DD} = 28 \text{ V}, I_{DQ} = 1.0 \text{ A}$$

**Typical Performance**



**Figure 4.** Simulated Maximum Available Gain and K Factor of the CGH40120P  
 $V_{DD} = 28\text{ V}, I_{DQ} = 1.0\text{ A}$

**Typical Performance**

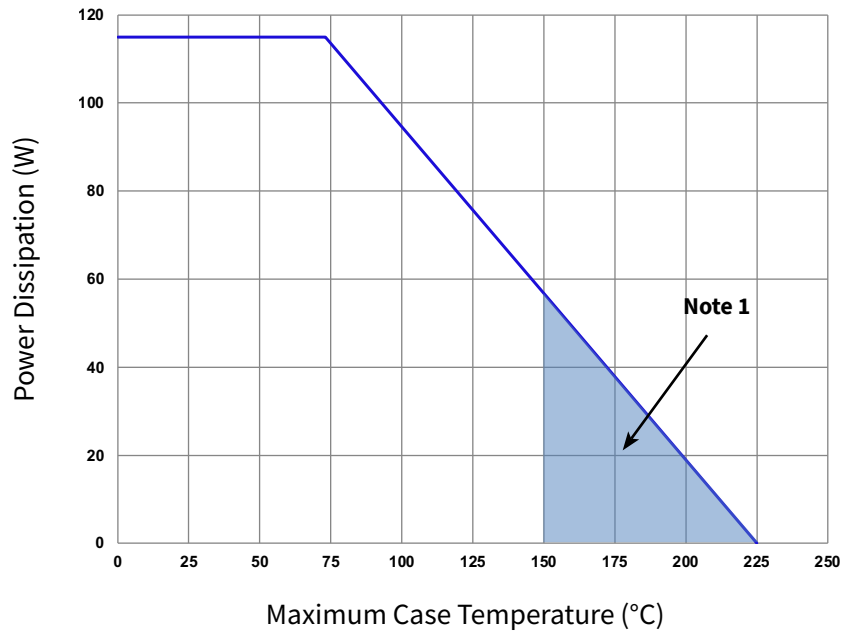


**Figure 5.** Simulated Minimum Noise Figure and Noise Resistance vs Frequency of the CGH40120P  
 $V_{DD} = 28\text{ V}, I_{DQ} = 1\text{ A}$

**Electrostatic Discharge (ESD) Classifications**

Parameter	Symbol	Class	Classification Level	Test Methodology
Human Body Model	HBM	1A		JEDEC JESD22 A114-D
Charge Device Model	CDM	0CB		JEDEC JESD22 C101-C

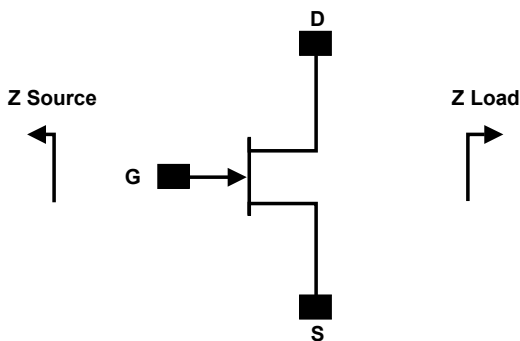
## CGH40120P CW Power Dissipation De-rating Curve



Note:

<sup>1</sup> Area exceeds Maximum Case Operating Temperature (See Page 2).

## Source and Load Impedances



Frequency	Z Source	Z Load
500	$2 + j3.3$	$5.14 + j0.04$
1000	$0.81 + j0.18$	$4.68 - j0.26$
1500	$0.75 - j1.56$	$3.44 - j0.77$
2000	$0.84 - j3$	$2.34 - j0.95$
2500	$1.2 - j4.43$	$2.7 - j2.56$
3000	$1.09 - j5.9$	$3.06 - j3.82$

Notes:

<sup>1</sup>  $V_{DD} = 28V$ ,  $I_{DQ} = 1.0 A$  in the 440206 package.

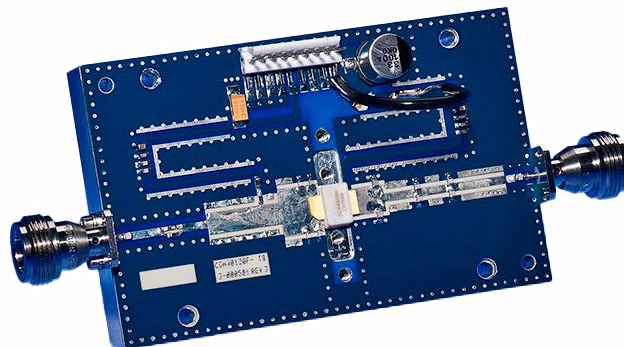
<sup>2</sup> Optimized for power gain,  $P_{SAT}$  and PAE.

<sup>3</sup> When using this device at low frequency, series resistors should be used to maintain amplifier stability.

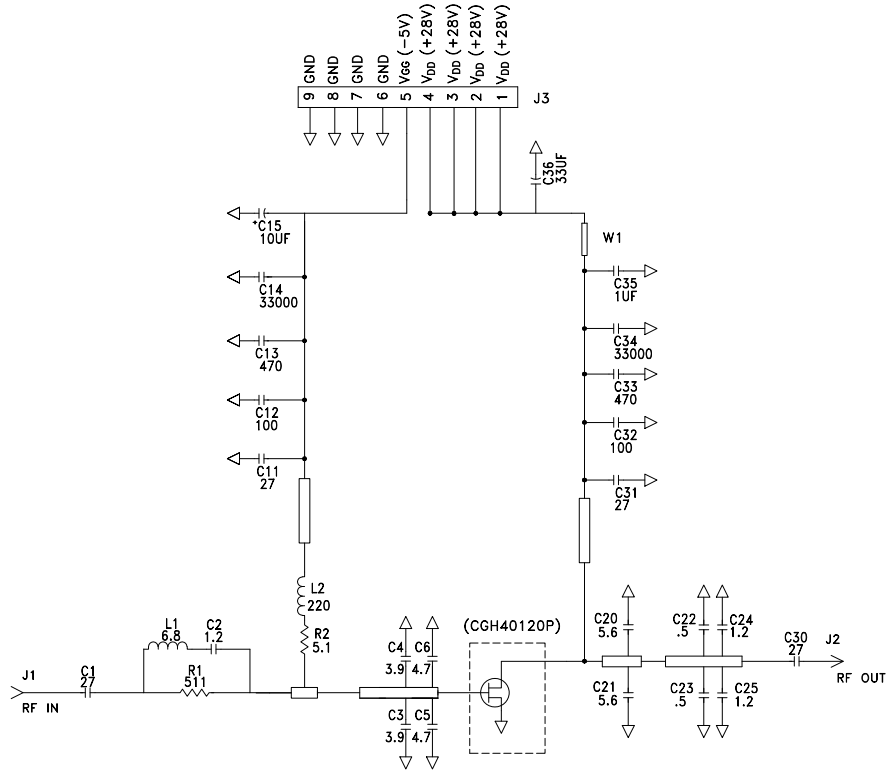
## CGH40120P-AMP Demonstration Amplifier Circuit Bill of Materials

Designator	Description	Qty
C1, C30	CAP, 27 pF +/- 5%, 250V, 0805, ATC 600F	2
C2	CAP, 1.2 pF, +/- 0.1 pF, 0603, ATC 600S	1
C3, C4	CAP, 3.9 pF, +/- 0.1 pF, 0603, ATC 600S	2
C5, C6	CAP, 4.7 pF, +/- 0.1 pF, 0603, ATC 600S	2
C11, C31	CAP, 27 pF, +/-5%, 0603, ATC 600S	2
C12, C32	CAP, 100 pF, +/- 5%, 0603, ATC 600S	2
C13, C33	CAP, 470 pF +/- 5%, 100 V, 0603, Murata	2
C14, C34	CAP, CER, 33000 pF, 100V, X7R, 0805, Murata	2
C15	CAP, 10 $\mu$ F, 16V, SMT, TANTALUM	1
C35	CAP, CER, 1.0 $\mu$ F, 100V, +/- 10%, X7R, 1210	1
C36	CAP, 33 $\mu$ F, 100V, ELECT, FK, SMD	1
C20, C21	CAP, 5.6 pF +/- 0.1 pF, 0805, ATC 600F	2
C22, C23	CAP, 0.5 pF +/- 0.05 pF, 0805, ATC 600F	2
C24, C25	CAP, 1.2 pF +/- 0.1 pF, 0805, ATC 600F	2
R1	RES, 1/16W, 0603, 511 ohms ( $\leq$ 5% tolerance)	1
R2	RES, 1/16W, 0603, 5.1 ohms ( $\leq$ 5% tolerance)	1
L1	IND, 6.8 nH, 0603, L-14C6N8ST	1
L2	IND, FERRITE, 220 ohm, 0805, BLM21PG221SN1	1
J1, J2	CONN, N-Type, Female, 0.500 SMA Flange	2
J3	CONN, Header, RT> PLZ, 0.1 CEN, LK, 9 POS	1
-	PCB, RO4003, Er = 3.38, h = 32 mil	1
Q1	CGH40120P	1

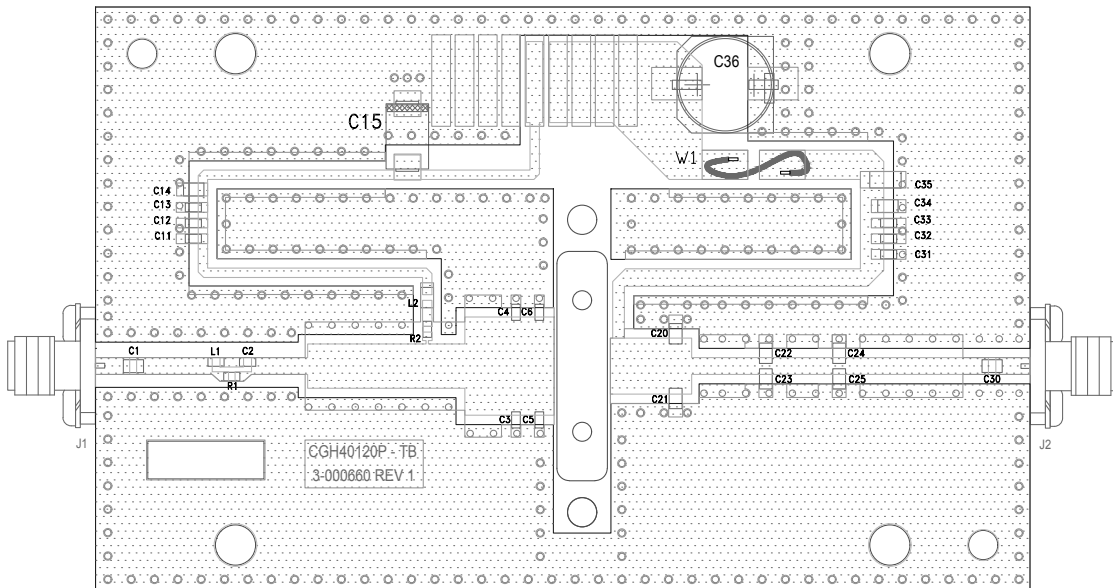
## CGH40120P-AMP Demonstration Amplifier Circuit



### CGH40120P-AMP Demonstration Amplifier Circuit Schematic



### CGH40120P-AMP Demonstration Amplifier Circuit Outline



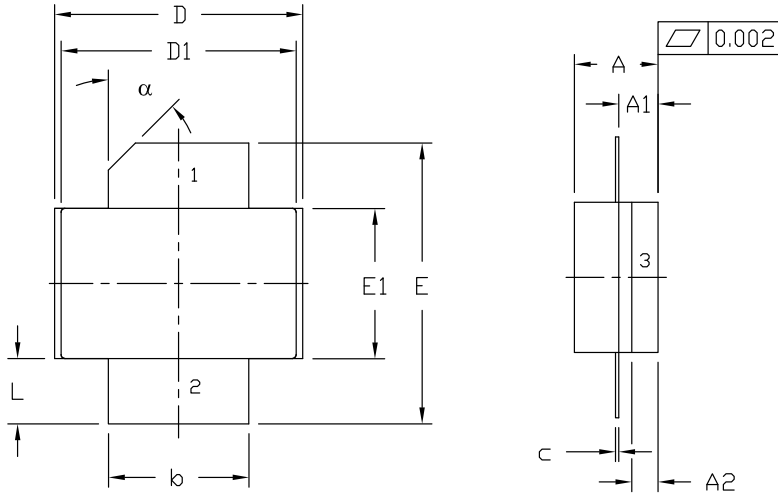


**Typical Package S-Parameters for CGH40120P**  
**(Small Signal,  $V_{DS} = 28\text{ V}$ ,  $I_{DQ} = 1.0\text{ A}$ , angle in degrees)**

Frequency	Mag S11	Ang S11	Mag S21	Ang S21	Mag S12	Ang S12	Mag S22	Ang S22
500 MHz	0.961	-177.60	4.19	80.16	0.006	13.42	0.807	-179.57
600 MHz	0.961	-178.85	3.49	77.38	0.006	15.30	0.808	-179.85
700 MHz	0.961	-179.89	2.99	74.72	0.006	17.30	0.810	179.89
800 MHz	0.961	179.22	2.61	72.16	0.007	19.36	0.811	179.66
900 MHz	0.961	178.41	2.32	69.66	0.007	21.47	0.813	179.42
1.0 GHz	0.960	177.67	2.09	67.22	0.007	23.59	0.815	179.18
1.1 GHz	0.960	176.96	1.89	64.83	0.007	25.71	0.817	178.94
1.2 GHz	0.960	176.28	1.73	62.49	0.007	27.81	0.819	178.68
1.3 GHz	0.960	175.63	1.60	60.18	0.007	29.86	0.822	178.41
1.4 GHz	0.960	174.99	1.48	57.92	0.008	31.86	0.824	178.13
1.5 GHz	0.960	174.36	1.38	55.69	0.008	33.80	0.826	177.83
1.6 GHz	0.960	173.73	1.30	53.50	0.008	35.65	0.828	177.52
1.7 GHz	0.960	173.11	1.22	51.35	0.008	37.40	0.830	177.19
1.8 GHz	0.959	172.49	1.15	49.23	0.009	39.06	0.832	176.84
1.9 GHz	0.959	171.86	1.10	47.15	0.009	40.61	0.835	176.47
2.0 GHz	0.959	171.23	1.04	45.09	0.010	42.04	0.837	176.09
2.1 GHz	0.958	170.59	0.99	43.07	0.010	43.36	0.839	175.69
2.2 GHz	0.958	169.95	0.95	41.08	0.011	44.56	0.840	175.28
2.3 GHz	0.957	169.29	0.91	39.12	0.011	45.64	0.842	174.85
2.4 GHz	0.957	168.63	0.88	37.18	0.012	46.60	0.844	174.40
2.5 GHz	0.956	167.95	0.85	35.28	0.012	47.45	0.845	173.93
2.6 GHz	0.956	167.26	0.82	33.39	0.013	48.18	0.847	173.45
2.7 GHz	0.955	166.56	0.79	31.53	0.014	48.80	0.848	172.94
2.8 GHz	0.954	165.84	0.77	29.68	0.014	49.32	0.849	172.43
2.9 GHz	0.953	165.10	0.75	27.86	0.015	49.74	0.850	171.89
3.0 GHz	0.952	164.34	0.73	26.04	0.016	50.05	0.851	171.33
3.2 GHz	0.950	162.75	0.70	22.46	0.018	50.40	0.852	170.17
3.4 GHz	0.948	161.07	0.68	18.91	0.020	50.38	0.852	168.93
3.6 GHz	0.944	159.27	0.66	15.37	0.023	50.02	0.852	167.61
3.8 GHz	0.941	157.33	0.65	11.82	0.025	49.32	0.850	166.19
4.0 GHz	0.936	155.23	0.64	8.23	0.029	48.30	0.848	164.68
4.2 GHz	0.931	152.94	0.64	4.57	0.033	46.94	0.844	163.06
4.4 GHz	0.925	150.43	0.64	0.80	0.037	45.24	0.840	161.32
4.6 GHz	0.917	147.66	0.65	-3.12	0.042	43.18	0.834	159.44
4.8 GHz	0.908	144.59	0.66	-7.23	0.048	40.72	0.826	157.41
5.0 GHz	0.896	141.14	0.68	-11.60	0.055	37.83	0.817	155.20
5.2 GHz	0.883	137.25	0.71	-16.29	0.064	34.45	0.805	152.81
5.4 GHz	0.866	132.84	0.74	-21.37	0.074	30.53	0.791	150.19
5.6 GHz	0.845	127.78	0.78	-26.94	0.086	25.97	0.774	147.33
5.8 GHz	0.820	121.95	0.83	-33.09	0.101	20.69	0.755	144.21
6.0 GHz	0.789	115.17	0.88	-39.95	0.118	14.58	0.731	140.79

To download the s-parameters in s2p format, go to the CGH40120P Product page.

**Product Dimensions CGH40120P (Package Type — 440206)**




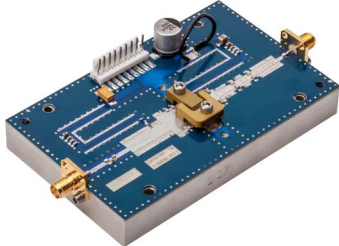
NOTES:

1. DIMENSIONING AND TOLERANCING PER ANSI Y14.5M - 1994.
2. CONTROLLING DIMENSION: INCH.
3. ADHESIVE FROM LID MAY EXTEND A MAXIMUM OF 0.020" BEYOND EDGE OF LID.
4. LID MAY BE MISALIGNED TO THE BODY OF PACKAGE BY A MAXIMUM OF 0.008" IN ANY DIRECTION.

DIM	INCHES		MILLIMETERS		NOTES
	MIN	MAX	MIN	MAX	
A	0.125	0.145	3.18	3.68	
A1	0.057	0.067	1.45	1.70	
A2	0.035	0.045	0.89	1.14	
b	0.210	0.220	5.33	5.59	2x
c	0.004	0.006	0.10	0.15	2x
D	0.375	0.385	9.53	9.78	
D1	0.355	0.365	9.02	9.27	
E	0.400	0.460	10.16	11.68	
E1	0.225	0.235	5.72	5.97	
L	0.085	0.115	2.16	2.92	2x
α	45° REF		45° REF		

- PIN 1. GATE  
 2. DRAIN  
 3. SOURCE

## Product Ordering Information

Order Number	Description	Unit of Measure	Image
CGH40120P	GaN HEMT	Each	
CGH40120P-AMP	Test board with GaN HEMT installed, 1.2 - 1.4 GHz	Each	

## Notes & Disclaimer

---

MACOM Technology Solutions Inc. ("MACOM"). All rights reserved.

These materials are provided in connection with MACOM's products as a service to its customers and may be used for informational purposes only. Except as provided in its Terms and Conditions of Sale or any separate agreement, MACOM assumes no liability or responsibility whatsoever, including for (i) errors or omissions in these materials; (ii) failure to update these materials; or (iii) conflicts or incompatibilities arising from future changes to specifications and product descriptions, which MACOM may make at any time, without notice. These materials grant no license, express or implied, to any intellectual property rights.

THESE MATERIALS ARE PROVIDED "AS IS" WITH NO WARRANTY OR LIABILITY, EXPRESS OR IMPLIED, RELATING TO SALE AND/OR USE OF MACOM PRODUCTS INCLUDING FITNESS FOR A PARTICULAR PURPOSE, MERCHANTABILITY, INFRINGEMENT OF INTELLECTUAL PROPERTY RIGHT, ACCURACY OR COMPLETENESS, OR SPECIAL, INDIRECT, INCIDENTAL, OR CONSEQUENTIAL DAMAGES WHICH MAY RESULT FROM USE OF THESE MATERIALS.

MACOM products are not intended for use in medical, lifesaving or life sustaining applications. MACOM customers using or selling MACOM products for use in such applications do so at their own risk and agree to fully indemnify MACOM for any damages resulting from such improper use or sale.